

# BIOLOGY

TEXTBOOK FOR CLASS XII



12083



एन सी ई आर टी  
NCERT

राष्ट्रीय शैक्षिक अनुसंधान और प्रशिक्षण परिषद्  
NATIONAL COUNCIL OF EDUCATIONAL RESEARCH AND TRAINING

## 12083 – BIOLOGY

Textbook for Class XII

ISBN 81-7450-639-X

### First Edition

December 2006 Pausa 1928

### Reprinted

November 2007, January 2009,  
December 2009, January 2011,  
January 2012, November 2012,  
November 2013, December 2014,  
January 2015, January 2017,  
January 2018, January 2019,  
August 2019, July 2021,  
November 2021

### Revised Edition

November 2022 Agrahayana 1944

PD 340T BS

© National Council of Educational  
Research and Training, 2006, 2022

₹ 205.00

Printed on 80 GSM paper with NCERT  
watermark

Published at the Publication Division by the  
Secretary, National Council of Educational  
Research and Training, Sri Aurobindo Marg,  
New Delhi 110 016 and printed at Taj  
Printers, 69/6A Najafgarh Road Industrial  
Area, Near Kirti Nagar Metro Station, New  
Delhi - 110 015

### ALL RIGHTS RESERVED

- No part of this publication may be reproduced, stored in a retrieval system or transmitted, in any form or by any means, electronic, mechanical, photocopying, recording or otherwise without the prior permission of the publisher.
- This book is sold subject to the condition that it shall not, by way of trade, be lent, re-sold, hired out or otherwise disposed of without the publisher's consent, in any form of binding or cover other than that in which it is published.
- The correct price of this publication is the price printed on this page. Any revised price indicated by a rubber stamp or by a sticker or by any other means is incorrect and should be unacceptable.

### OFFICES OF THE PUBLICATION DIVISION, NCERT

NCERT Campus  
Sri Aurobindo Marg  
New Delhi 110 016

Phone : 011-26562708

108, 100 Feet Road  
Hosdakere Halli Extension  
Banashankari III Stage  
Bengaluru 560 085

Phone : 080-26725740

Navjivan Trust Building  
P.O. Navjivan  
Ahmedabad 380 014

Phone : 079-27541446

CWC Campus  
Opp. Dhankal Bus Stop  
Panihati  
Kolkata 700 114

Phone : 033-25530454

CWC Complex  
Maligaon  
Guwahati 781 021

Phone : 0361-2674869

### Publication Team

Head, Publication Division : Anup Kumar Rajput  
Chief Production Officer : Arun Chitkara  
Chief Business Manager : Vipin Dewan  
Chief Editor (In charge) : Bijnan Sutar  
Assistant Editor : Shashi Chadha  
Production Officer : A.M. Vinod Kumar

### Cover and Layout

Shweta Rao

### Illustrations

Lalit Maurya


# FOREWORD

The National Curriculum Framework (NCF) 2005, recommends that children's life at school must be linked to their life outside the school. This principle marks a departure from the legacy of bookish learning which continues to shape our system and causes a gap between the school, home and community. The syllabi and textbooks developed on the basis of NCF signify an attempt to implement this basic idea. They also attempt to discourage rote learning and the maintenance of sharp boundaries between different subject areas. We hope these measures will take us significantly further in the direction of a child-centred system of education outlined in the National Policy on Education (1986).

The success of this effort depends on the steps that school principals and teachers will take to encourage children to reflect on their own learning and to pursue imaginative activities and questions. We must recognise that, given space, time and freedom, children generate new knowledge by engaging with the information passed on to them by adults. Treating the prescribed textbook as the sole basis of examination is one of the key reasons why other resources and sites of learning are ignored. Inculcating creativity and initiative is possible if we perceive and treat children as participants in learning, not as receivers of a fixed body of knowledge.

These aims imply considerable change in school routines and mode of functioning. Flexibility in the daily time-table is as necessary as rigour in implementing the annual calendar so that the required number of teaching days are actually devoted to teaching. The methods used for teaching and evaluation will also determine how effective this textbook proves for making children's life at school a happy experience, rather than a source of stress or boredom. Syllabus designers have tried to address the problem of curricular burden by restructuring and reorienting knowledge at different stages with greater consideration for child psychology and the time available for teaching. The textbook attempts to enhance this endeavour by giving higher priority and space to opportunities for contemplation and wondering, discussion in small groups, and activities requiring hands-on experience.

The National Council of Educational Research and Training (NCERT) appreciates the hard work done by the textbook development committee responsible for this book. We wish to thank the Chairperson of the advisory group in science and mathematics, Professor J.V. Narlikar and the Chief Advisor for this book, Professor K. Muralidhar, Department of Zoology, University of Delhi, Delhi for guiding the work of this committee. Several teachers contributed to the development of this textbook. We are grateful to their principals for making this possible. We are indebted to the institutions and organisations which have generously permitted us to draw upon their resources, material and personnel. We are especially grateful to the members of the National Monitoring Committee, appointed



by the Department of Secondary and Higher Education, Ministry of Human Resource Development under the Chairmanship of Professor Mrinal Miri and Professor G.P. Deshpande, for their valuable time and contribution.

As an organisation committed to systemic reform and continuous improvement in the quality of its products, NCERT welcomes comments and suggestions which will enable us to undertake further revision and refinement.

New Delhi  
20 November 2006

*Director*  
National Council of Educational  
Research and Training

# RATIONALISATION OF CONTENT IN THE TEXTBOOK

In view of the COVID-19 pandemic, it is imperative to reduce content load on students. The National Education Policy 2020, also emphasises reducing the content load and providing opportunities for experiential learning with creative mindset. In this background, the NCERT has undertaken the exercise to rationalise the textbooks across all classes. Learning Outcomes already developed by the NCERT across classes have been taken into consideration in this exercise.

**Contents of the textbooks have been rationalised in view of the following:**

- Overlapping with similar content included in other subject areas in the same class
- Similar content included in the lower or higher class in the same subject
- Difficulty level
- Content, which is easily accessible to students without much interventions from teachers and can be learned by children through self-learning or peer-learning
- Content, which is irrelevant in the present context

This present edition, is a reformatted version after carrying out the changes given above.

© NCERT  
not to be republished

# PREFACE

Biology is the study of life in its entirety. The growth of biology as a natural science during the last 1000 years is interesting from many points of view. One feature of this growth is changing emphasis. Initially it was description of life forms. Identification, nomenclature, classification of all recorded living forms enjoyed the attention of scientists for a long time. Description of their habitats and (in the case of animals) their behaviour was included in this study. In later years, the focus was physiology and internal morphology or anatomy. Darwinian ideas of evolution by natural selection changed the perception completely. Classical descriptive and clueless biology found a theoretical framework in the evolutionary theory of Darwin.

In the nineteenth and twentieth centuries, Physics and Chemistry were applied to Biology and the new science of Biochemistry soon became the dominant face of biology. On one hand Biochemistry was integrating with Physiology, becoming almost synonymous with it. On the other hand it gave rise to Structural Biology (structure of biomacromolecules), originally called Molecular Biology. The work of Bernal, Pauling, Watson and Crick, Hodgkins, Perutz and Kendrew, Delbruck, Luria, Monod, Beadle and Tatum, Lederberg, Brenner, Benzer, Nirenberg, Khorana, McIntock, Sanger, Cohen, Boyer, Kornbergs (father and son), Leder, Chambon and scores of others brought in and established a modern version of Molecular Biology dealing with life processes at molecular level.

Physics and Chemistry dominated public perception of science for a long time. Daytoday life of man was influenced by developments in Physics, Chemistry and their respective manufacturing industries. Slowly and steadily, Biology, not to be left behind, demonstrated its utility for human welfare. Medical practice, especially diagnostics, green revolution and the newly emerging biotechnology and its success stories made the presence of biology felt by the common man. Patent laws brought biology into political domain and commercial value of biology became obvious.

For more than a century, classical and so-called reductionist biology fought artificial battles. The fact is both are important. Ecology brought in synthesis of both approaches and emphasised integrated understanding of biology. Form and process are both equally important. Systems biology, using mathematical tools, is bringing about a modern synthesis of both the aspects of Biology.

The Class XI and XII textbooks in biology essentially were to reflect these threads of biological thought. While the Class XI book dealt with morphology, taxonomy, molecular and cellular aspects of physiology, the Class XII book deals with the physiological process of reproduction in flowering plants and humans, the principles of inheritance, the nature of genetic material and its function, the contributions of biology to human welfare, basic principles of biotechnological processes and their applications and achievements. The Class XII book also relates genes to evolution on one hand and presents ecological interactions, behaviour of populations and ecosystems on the other. Most important, the guidelines under NCF-2005 have been followed in letter and spirit. The total learning load has been reduced

considerably and themes like environmental issues, adolescent problems and reproductive health have been dealt with in some detail. Studied together, the class XI and class XII textbooks in Biology would enable the student to —

- (i) become familiar with the diversity of biological material.
- (ii) appreciate and believe in the Darwinian evolutionary process exhibited by the living world.
- (iii) understand the dynamic state of constituents of living bodies, i.e., metabolic basis of all physiological processes in plants, animals and microbes.
- (iv) realise the structure and function of genetic material in directing the inherited phenotype pattern as well as a mediator of evolutionary process.
- (v) appreciate the profound contributions of biology to human welfare.
- (vi) reflect on the physico-chemical basis of living processes and at the same time realise the limitation of reductionism in understanding behaviour of organisms.
- (vii) experience the humbling effect of this realisation that all living organisms are related to each other by virtue of shared genetic material.
- (viii) realise that biology is the story of the struggle of living organisms for existence and survival.

One may notice a perceptible change in the writing style. Most of the chapters are written in an easy dialogue style engaging the student constantly while some chapters are in the form of critical comments on the subject matter. A number of questions have been provided at the end of each chapter though answers to some may not be found in the text. Students have to read supplementary material, upon advise from the teacher, to answer such questions.

I am thankful to Professor Krishna Kumar, Director NCERT; Professor G. Ravindra, Joint Director, NCERT and Professor Hukum Singh, Head, DESM, NCERT for constant support. I must place on record my deep appreciation for Dr B.K. Tripathi, *Reader*, DESM, NCERT for his relentless efforts as coordinator in bringing out the Biology textbook for both the Class XI and XII. All the members of the development team, the experts and reviewers, and the school teachers have contributed enormously in the preparation of this book. I thank them all. I am indeed highly thankful to the members of monitoring committee constituted by Ministry of Human Resource Development for their valuable observation that helped in the improvement of the book at the final stage. The book is prepared keeping in mind the guidelines of the NCF-2005 especially the emphasis on reducing the learning load. We hope that the book would meet the expectations of all the stakeholders. All suggestions for further improvement are always welcome.

Department of Zoology  
University of Delhi

K. MURALIDHAR  
*Chief Advisor*  
Biology Textbook for Class XII



# TEXTBOOK DEVELOPMENT COMMITTEE

## **CHAIRPERSON, ADVISORY GROUP FOR TEXTBOOKS IN SCIENCE AND MATHEMATICS**

J.V. Narlikar, *Emeritus Professor*, Inter University Centre for Astronomy and Astrophysics (IUCAA), Pune University, Pune

## **CHIEF ADVISOR**

K. Muralidhar, *Professor*, Department of Zoology, University of Delhi, Delhi

## **MEMBERS**

Ajit Kumar Kavathekar, *Reader* (Botany), Sri Venkateswara College, University of Delhi, Delhi

B.B.P. Gupta, *Professor*, Department of Zoology, North-Eastern Hill University, Shillong

B.N. Pandey, *Principal*, Ordinance Factory Higher Secondary School, Dehradun

C.V. Shimray, *Lecturer*, Department of Education in Science and Mathematics, NCERT, New Delhi

Dinesh Kumar, *Reader*, Department of Education in Science and Mathematics, NCERT, New Delhi

J.P. Gaur, *Professor*, Department of Botany, Banaras Hindu University, Varanasi

J.S. Viridi, *Reader*, Department of Microbiology, University of Delhi, South Campus, New Delhi

K. Sarath Chandran, *Reader* (Zoology), Sri Venkateswara College, University of Delhi, Delhi

L.C. Rai, *Professor*, Department of Botany, Banaras Hindu University, Varanasi

M.M. Chaturvedi, *Professor*, Department of Zoology, University of Delhi, Delhi

N.V.S.R.K. Prasad, *Reader* (Botany), Sri Venkateswara College, University of Delhi, Delhi

Sangeeta Sharma, *PGT* (Biology), Kendriya Vidyalaya, JNU, New Delhi

Savithri Singh, *Principal*, Acharya Narendra Dev College, University of Delhi, Delhi

Shanti Chandrashekar, *Principal Scientist*, Division of Genetics, I.A.R.I., New Delhi

Shardendu, *Reader*, Department of Botany, Science College, Patna University, Patna

Simminder K. Thukral, *Assistant Professor*, NIIT Institute of Information Technology, New Delhi

Sunaina Sharma, *Lecturer* (Biology), Rajkiya Pratibha Vikas Vidyalaya, Dwarka, New Delhi

T.R. Rao, *Professor* (Retd.) School of Environmental Studies, University of Delhi, Delhi

V.K. Kakaria, *Reader*, Regional Institute of Education, Bhopal

V.V. Anand, *Reader*, Regional Institute of Education, Mysore

## **MEMBER-COORDINATOR**

B.K. Tripathi, *Reader*, Department of Education in Science and Mathematics, NCERT, New Delhi

# ACKNOWLEDGEMENTS

National Council of Educational Research and Training (NCERT) gratefully acknowledges the valuable contribution of K.R. Shivanna, *Professor (Retd.)*, Department of Botany, University of Delhi, Delhi; S.K. Saidapur, *Professor*, Department of Zoology, Karnataka University Dharwad; Vani Brahmachari, *Professor*, Ambedkar Centre for Biomedical Research, University of Delhi, Delhi; A.N. Lahiri Majumdar, *Professor*, Bose Institute, Kolkata; Anil Tripathi, *Professor*, Department of Biotechnology, Banaras Hindu University, Varanasi; J.L. Jain, *Senior Physician*, WUS Health Centre, University of Delhi, Delhi, in the development of the Biology textbook for Class XII. NCERT is also grateful to K.R. Shivanna and T.Subramanyam, IIT, Kanpur for some of the photographs used in the book.

NCERT sincerely acknowledges the contributions of the members who participated in the review of the manuscripts – A.S. Dixit, *Reader*, Department of Zoology, North-Eastern Hill University, Shillong; S.L. Varte, *Lecturer*, Department of Education in Science and Mathematics, NCERT, New Delhi; Sushma Jairath, *Reader*, Department of Women's Education, NCERT, New Delhi; Mona Yadav, *Lecturer*, Department of Women's Education, NCERT, New Delhi; Poonam A. Kant, *Reader (Zoology)*, Acharya Narendra Dev College, New Delhi; Mrs. Suvarna Fonseca è Antao, *Gr. I Teacher (Biology)*, Carmel Higher Secondary School, Nuvem, Goa; Rashmi Mishra, *PGT (Biology)*, Carmel Convent Senior Secondary School, BHEL, Bhopal; Ishwant Kaur, *PGT (Biology)*, D.M. School, RIE, Bhopal; A.K. Singh, *PGT (Biology)*, Kendriya Vidyalaya, Cantt, Varanasi; R.P. Singh, *Lecturer (Biology)*, Rajkiya Pratibha Vikash Vidyalaya, Kishan ganj, Delhi; M.K. Tiwari, *PGT (Biology)*, Kendriya Vidyalaya, Mandsaur, Madhya Pradesh; A.K. Ganguly, *PGT (Biology)*, Jawahar Navodaya Vidyalaya, Roshnabad, Haridwar; Chaitali Dixit, *PGT (Biology)*, St. Anthony's Higher Secondary School (Don Bosco), Shillong and Abhishek Chari, Acharya Narendra Dev College, New Delhi.

Special thanks are due to Rita Sharma, *Retd. Professor*, RIE Bhopal, A.K. Mohapatra *Professor*, RIE Bhubaneswar, J.S. Gill, *Retd. Professor*, DESM, NIE, G.V. Gopal, *Professor*, RIE Mysore, Jaydeep Mandal, *Professor*, RIE Bhopal, C. Padmija, *Professor*, RIE Mysore, Dr. Pushplata Verma, *Associate Professor*, DESM, NIE, Ishwant Kaur, *Vice Principal*, DM School Ajmer for their valuable contribution in review and updation of the textbook.

The Council is highly thankful to Hukum Singh, *Professor and Head*, Department of Education in Science and Mathematics, NCERT for his valuable support throughout the making of this book.

The contributions of Deepak Kapoor, *Incharge*, Computer Station; Seema Mehmi and Arvind Sharma, *DTP operators*; Deepti Sharma, *Copy Editor*; Rachna Dogra and Abhimanu Mohanty, *Proof Readers* and APC office and administrative staff of Department of Education in Science and Mathematics, NCERT also acknowledged.

The efforts of the Publication Department, NCERT, in bringing out this publication are highly appreciated.

# CONTENTS

<b>FOREWORD</b>	<i>iii</i>
<b>RATIONALISATION OF CONTENT IN THE TEXTBOOK</b>	<i>v</i>
<b>PREFACE</b>	<i>vii</i>

## UNIT VI

<b>REPRODUCTION</b>	<b>1-50</b>
Chapter 1 : Sexual Reproduction in Flowering Plants	3
Chapter 2 : Human Reproduction	26
Chapter 3 : Reproductive Health	41

## UNIT VII

<b>GENETICS AND EVOLUTION</b>	<b>51-126</b>
Chapter 4 : Principles of Inheritance and Variation	53
Chapter 5 : Molecular Basis of Inheritance	79
Chapter 6 : Evolution	110

## UNIT VIII

<b>BIOLOGY IN HUMAN WELFARE</b>	<b>127-160</b>
Chapter 7 : Human Health and Disease	129
Chapter 8 : Microbes in Human Welfare	149

## UNIT IX

<b>BIOTECHNOLOGY</b>	<b>161-187</b>
Chapter 9 : Biotechnology : Principles and Processes	163
Chapter 10 : Biotechnology and its Applications	177



**UNIT X**

**ECOLOGY**

**188-227**

Chapter 11 : Organisms and Populations 189

Chapter 12 : Ecosystem 205

Chapter 13 : Biodiversity and Conservation 216

© NCERT  
not to be republished

# UNIT VI

# REPRODUCTION

## **Chapter 1**

Sexual Reproduction in  
flowering Plants

## **Chapter 2**

Human Reproduction

## **Chapter 3**

Reproductive Health

Biology in essence is the story of life on earth. While individual organisms die without fail, species continue to live through millions of years unless threatened by natural or anthropogenic extinction. Reproduction becomes a vital process without which species cannot survive for long. Each individual leaves its progeny by asexual or sexual means. Sexual mode of reproduction enables creation of new variants, so that survival advantage is enhanced. This unit explains the details of reproductive processes in flowering plants and humans as easy to relate representative examples. A related perspective on human reproductive health and how reproductive ill health can be avoided is also presented to complete our understanding of biology of reproduction.





PANCHANAN MAHESHWARI  
(1904-1966)

Born in November 1904 in Jaipur (Rajasthan) Panchanan Maheshwari rose to become one of the most distinguished botanists not only of India but of the entire world. He moved to Allahabad for higher education where he obtained his D.Sc. During his college days, he was inspired by Dr W. Dudgeon, an American missionary teacher, to develop interest in Botany and especially morphology. His teacher once expressed that if his student progresses ahead of him, it will give him a great satisfaction. These words encouraged Panchanan to enquire what he could do for his teacher in return.

He worked on embryological aspects and popularised the use of embryological characters in taxonomy. He established the Department of Botany, University of Delhi as an important centre of research in embryology and tissue culture. He also emphasised the need for initiation of work on artificial culture of immature embryos. These days, tissue culture has become a landmark in science. His work on test tube fertilisation and intra-ovarian pollination won worldwide acclaim.

He was honoured with fellowship of Royal Society of London (FRS), Indian National Science Academy and several other institutions of excellence. He encouraged general education and made a significant contribution to school education by his leadership in bringing out the very first textbooks of Biology for Higher Secondary Schools published by NCERT in 1964.

# CHAPTER 1



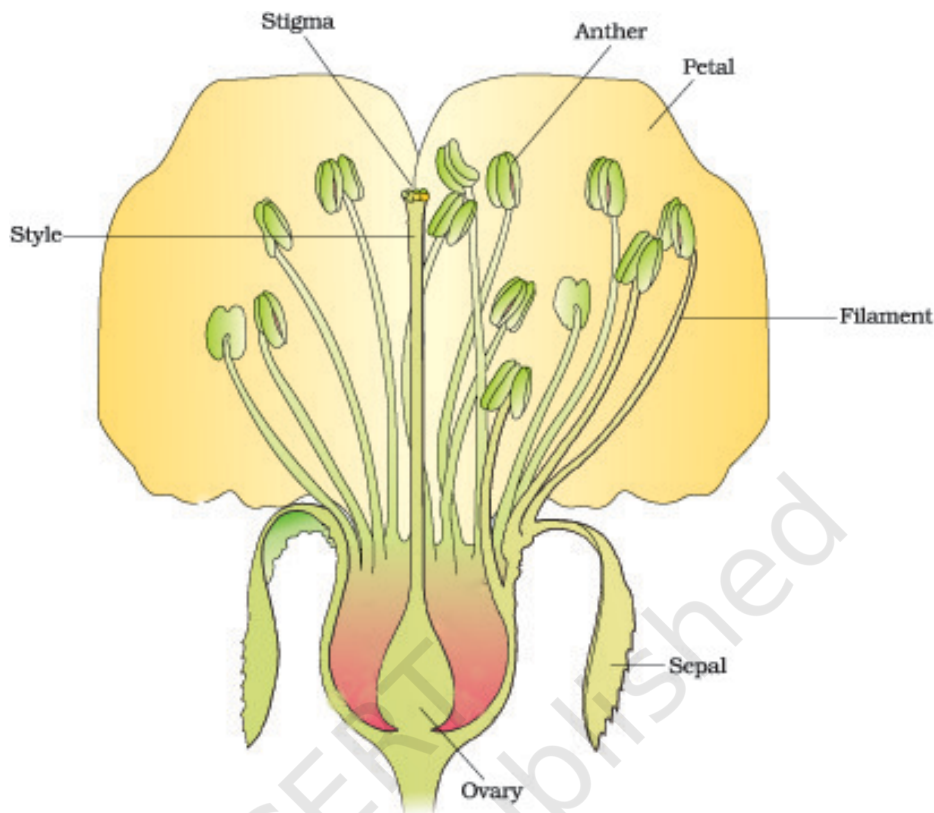
## SEXUAL REPRODUCTION IN FLOWERING PLANTS

- 1.1 *Flower – A Fascinating Organ of Angiosperms*
- 1.2 *Pre-fertilisation : Structures and Events*
- 1.3 *Double Fertilisation*
- 1.4 *Post-fertilisation: Structures and Events*
- 1.5 *Apomixis and Polyembryony*

Are we not lucky that plants reproduce sexually? The myriads of flowers that we enjoy gazing at, the scents and the perfumes that we swoon over, the rich colours that attract us, are all there as an aid to sexual reproduction. Flowers do not exist only for us to be used for our own selfishness. All flowering plants show sexual reproduction. A look at the diversity of structures of the inflorescences, flowers and floral parts, shows an amazing range of adaptations to ensure formation of the end products of sexual reproduction, the fruits and seeds. In this chapter, let us understand the morphology, structure and the processes of sexual reproduction in flowering plants (angiosperms).

### 1.1 FLOWER – A FASCINATING ORGAN OF ANGIOSPERMS

Human beings have had an intimate relationship with flowers since time immemorial. Flowers are objects of aesthetic, ornamental, social, religious and cultural value – they have always been used as symbols for conveying important human feelings such as love, affection, happiness, grief, mourning, etc. *List at least five flowers of ornamental value that are commonly cultivated at*



**Figure 1.1** A diagrammatic representation of L.S. of a flower

homes and in gardens. Find out the names of five more flowers that are used in social and cultural celebrations in your family. Have you heard of floriculture – what does it refer to?

To a biologist, flowers are morphological and embryological marvels and the sites of sexual reproduction. In earlier classes, you have read the various parts of a flower. Figure 1.1 will help you recall the parts of a typical flower. Can you name the two parts in a flower in which the two most important units of sexual reproduction develop?

## 1.2 PRE-FERTILISATION: STRUCTURES AND EVENTS

Much before the actual flower is seen on a plant, the decision that the plant is going to flower has taken place. Several hormonal and structural changes are initiated which lead to the differentiation and further development of the floral primordium. Inflorescences are formed which bear the floral buds and then the flowers. In the flower the male and female reproductive structures, the androecium and the gynoecium differentiate and develop. You would recollect that the androecium consists of a whorl of stamens representing the male reproductive organ and the gynoecium represents the female reproductive organ.





### 1.2.1 Stamen, Microsporangium and Pollen Grain

Figure 1.2a shows the two parts of a typical **stamen** – the long and slender stalk called the **filament**, and the terminal generally bilobed structure called the **anther**. The proximal end of the filament is attached to the thalamus or the petal of the flower. The number and length of stamens are variable in flowers of different species. If you were to collect a stamen each from ten flowers (each from different species) and arrange them on a slide, you would be able to appreciate the large variation in size seen in nature. Careful observation of each stamen under a dissecting microscope and making neat diagrams would elucidate the range in shape and attachment of anthers in different flowers.

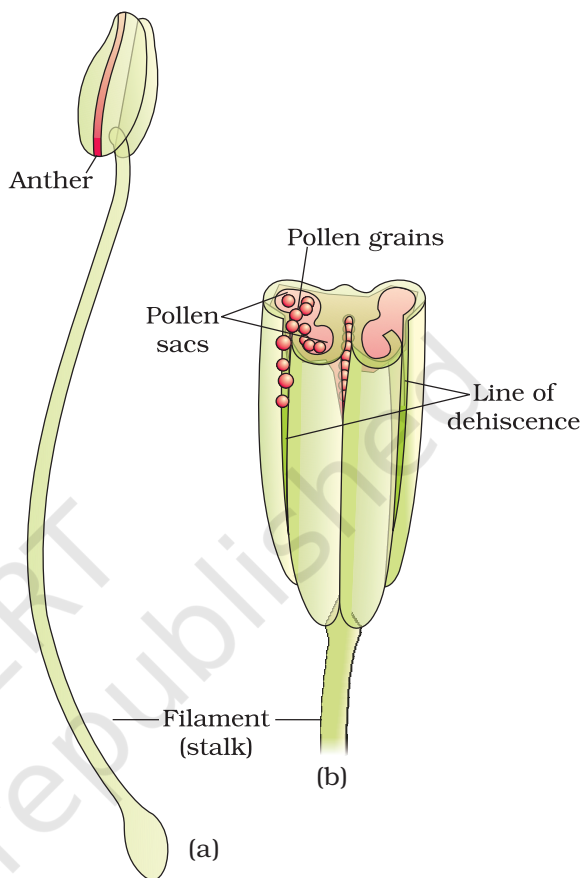
A typical angiosperm anther is **bilobed** with each lobe having two theca, i.e., they are **dithecous** (Figure 1.2b). Often a longitudinal groove runs lengthwise separating the theca. Let us understand the various types of tissues and their organisation in the transverse section of an anther (Figure 1.3a). The bilobed nature of an anther is very distinct in the transverse section of the anther. The anther is a four-sided (tetragonal) structure consisting of four **microsporangia** located at the corners, two in each lobe.

The microsporangia develop further and become **pollen sacs**. They extend longitudinally all through the length of an anther and are packed with pollen grains.

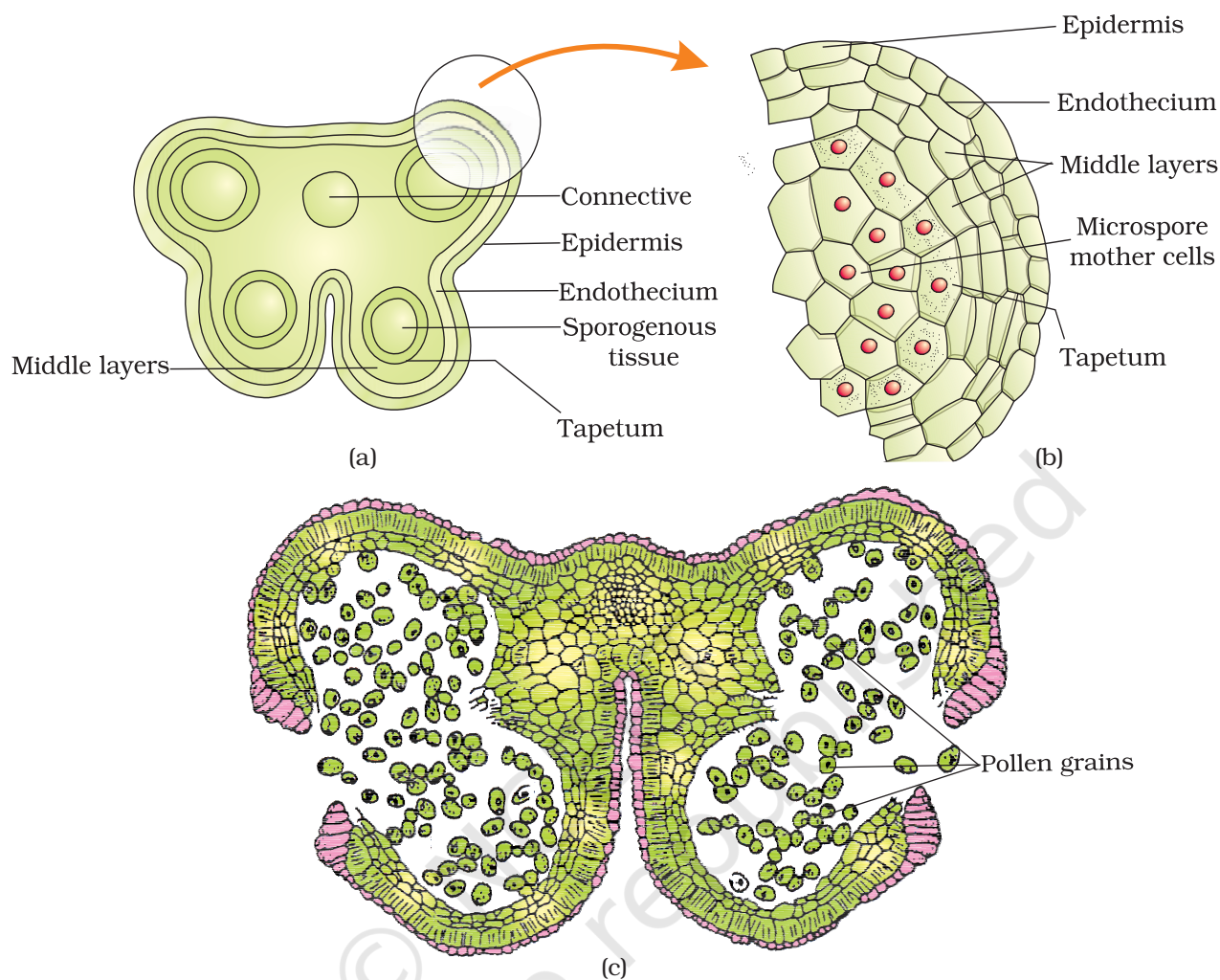
**Structure of microsporangium:** In a transverse section, a typical microsporangium appears near circular in outline. It is generally surrounded by four wall layers (Figure 1.3b)– the epidermis, endothecium, middle layers and the tapetum. The outer three wall layers perform the function of protection and help in dehiscence of anther to release the pollen. The innermost wall layer is the **tapetum**. It nourishes the developing pollen grains. Cells of the tapetum possess dense cytoplasm and generally have more than one nucleus. *Can you think of how tapetal cells could become bi-nucleate?*

When the anther is young, a group of compactly arranged homogenous cells called the **sporogenous tissue** occupies the centre of each microsporangium.

**Microsporogenesis :** As the anther develops, the cells of the sporogenous tissue undergo meiotic divisions to form microspore tetrads. *What would be the ploidy of the cells of the tetrad?*



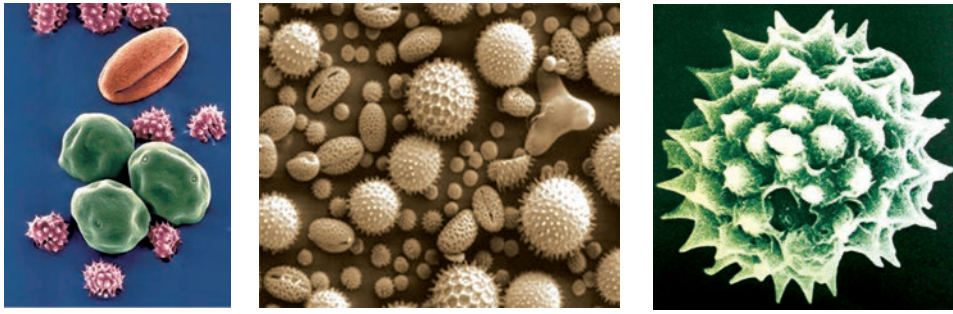
**Figure 1.2** (a) A typical stamen; (b) three-dimensional cut section of an anther



**Figure 1.3** (a) Transverse section of a young anther; (b) Enlarged view of one microsporangium showing wall layers; (c) A mature dehiscent anther

As each cell of the sporogenous tissue is capable of giving rise to a microspore tetrad. Each one is a potential pollen or microspore mother cell. The process of formation of microspores from a pollen mother cell (PMC) through meiosis is called **microsporogenesis**. The microspores, as they are formed, are arranged in a cluster of four cells—the **microspore tetrad** (Figure 1.3a). As the anthers mature and dehydrate, the microspores dissociate from each other and develop into **pollen grains** (Figure 1.3b). Inside each microsporangium several thousands of microspores or pollen grains are formed that are released with the dehiscence of anther (Figure 1.3c).

**Pollen grain:** The pollen grains represent the male gametophytes. If you touch the opened anthers of *Hibiscus* or any other flower you would find deposition of yellowish powdery pollen grains on your fingers. Sprinkle these grains on a drop of water taken on a glass slide and observe under



**Figure 1.4** Scanning electron micrographs of a few pollen grains

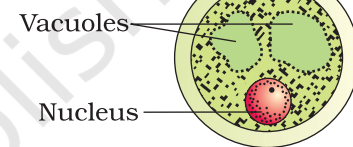
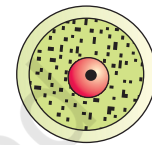
a microscope. You will really be amazed at the variety of architecture – sizes, shapes, colours, designs – seen on the pollen grains from different species (Figure 1.4).

Pollen grains are generally spherical measuring about 25-50 micrometers in diameter. It has a prominent two-layered wall. The hard outer layer called the **exine** is made up of sporopollenin which is one of the most resistant organic material known. It can withstand high temperatures and strong acids and alkali. No enzyme that degrades sporopollenin is so far known. Pollen grain exine has prominent apertures called **germ pores** where sporopollenin is absent. Pollen grains are well-preserved as fossils because of the presence of sporopollenin. The exine exhibits a fascinating array of patterns and designs. *Why do you think the exine should be hard? What is the function of germ pore?* The inner wall of the pollen grain is called the **intine**. It is a thin and continuous layer made up of cellulose and pectin. The cytoplasm of pollen grain is surrounded by a plasma membrane. When the pollen grain is mature it contains two cells, the **vegetative cell** and **generative cell** (Figure 1.5b). The vegetative cell is bigger, has abundant food reserve and a large irregularly shaped nucleus. The **generative cell** is small and floats in the cytoplasm of the vegetative cell. It is spindle shaped with dense cytoplasm and a nucleus. In over 60 per cent of angiosperms, pollen grains are shed at this 2-celled stage. In the remaining species, the generative cell divides mitotically to give rise to the two male gametes before pollen grains are shed (3-celled stage).

Pollen grains of many species cause severe allergies and bronchial afflictions in some people often leading to chronic respiratory disorders – asthma, bronchitis, etc. It may be mentioned that *Parthenium* or carrot grass that came into India as a contaminant with imported wheat, has become ubiquitous in occurrence and causes pollen allergy.

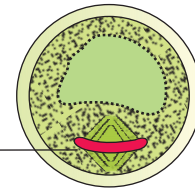


(a)

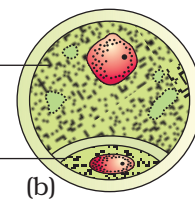


Vacuoles

Nucleus



Asymmetric spindle



Vegetative cell

Generative cell

(b)

**Figure 1.5** (a) Enlarged view of a pollen grain tetrad; (b) stages of a microspore maturing into a pollen grain

Pollen grains are rich in nutrients. It has become a fashion in recent years to use pollen tablets as food supplements. In western countries, a large number of pollen products in the form of tablets and syrups are available in the market. Pollen consumption has been claimed to increase the performance of athletes and race horses (Figure 1.6).

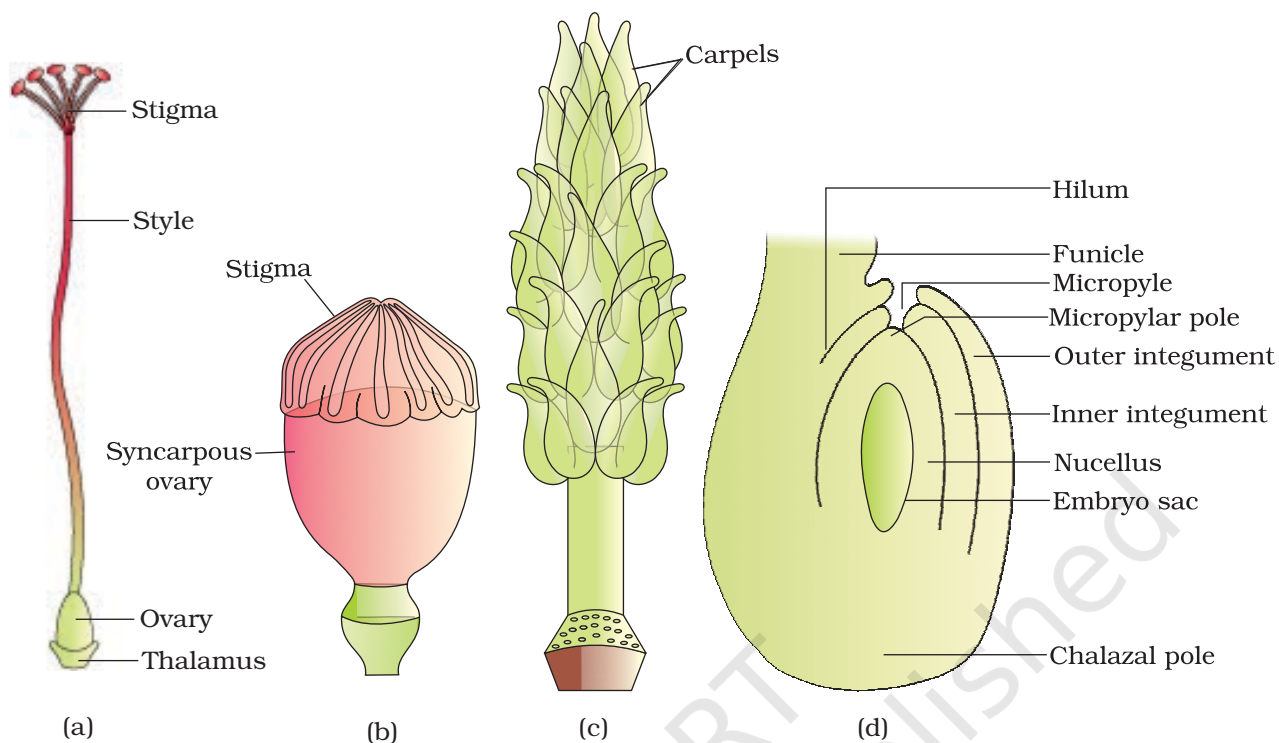


**Figure 1.6** Pollen products

When once they are shed, pollen grains have to land on the stigma before they lose viability if they have to bring about fertilisation. How long do you think the pollen grains retain viability? The period for which pollen grains remain viable is highly variable and to some extent depends on the prevailing temperature and humidity. In some cereals such as rice and wheat, pollen grains lose viability within 30 minutes of their release, and in some members of Rosaceae, Leguminosae and Solanaceae, they maintain viability for months. You may have heard of storing semen/sperms of many animals including humans for artificial insemination. It is possible to store pollen grains of a large number of species for years in liquid nitrogen ( $-196^{\circ}\text{C}$ ). Such stored pollen can be used as pollen banks, similar to seed banks, in crop breeding programmes.

### 1.2.2 The Pistil, Megasporangium (ovule) and Embryo sac

The gynoecium represents the female reproductive part of the flower. The gynoecium may consist of a single pistil (**monocarpellary**) or may have more than one pistil (**multicarpellary**). When there are more than one, the pistils may be fused together (**syncarpous**) (Figure 1.7b) or may be free (**apocarpous**) (Figure 1.7c). Each pistil has three parts (Figure 1.7a), **the stigma, style and ovary**. The **stigma** serves as a landing platform for pollen grains. The style is the elongated slender part beneath the stigma. The basal bulged part of the pistil is the **ovary**. Inside the ovary is the **ovarian cavity (locule)**. **The placenta** is located inside the ovarian cavity. Recall the definition and types of placentation that you studied in



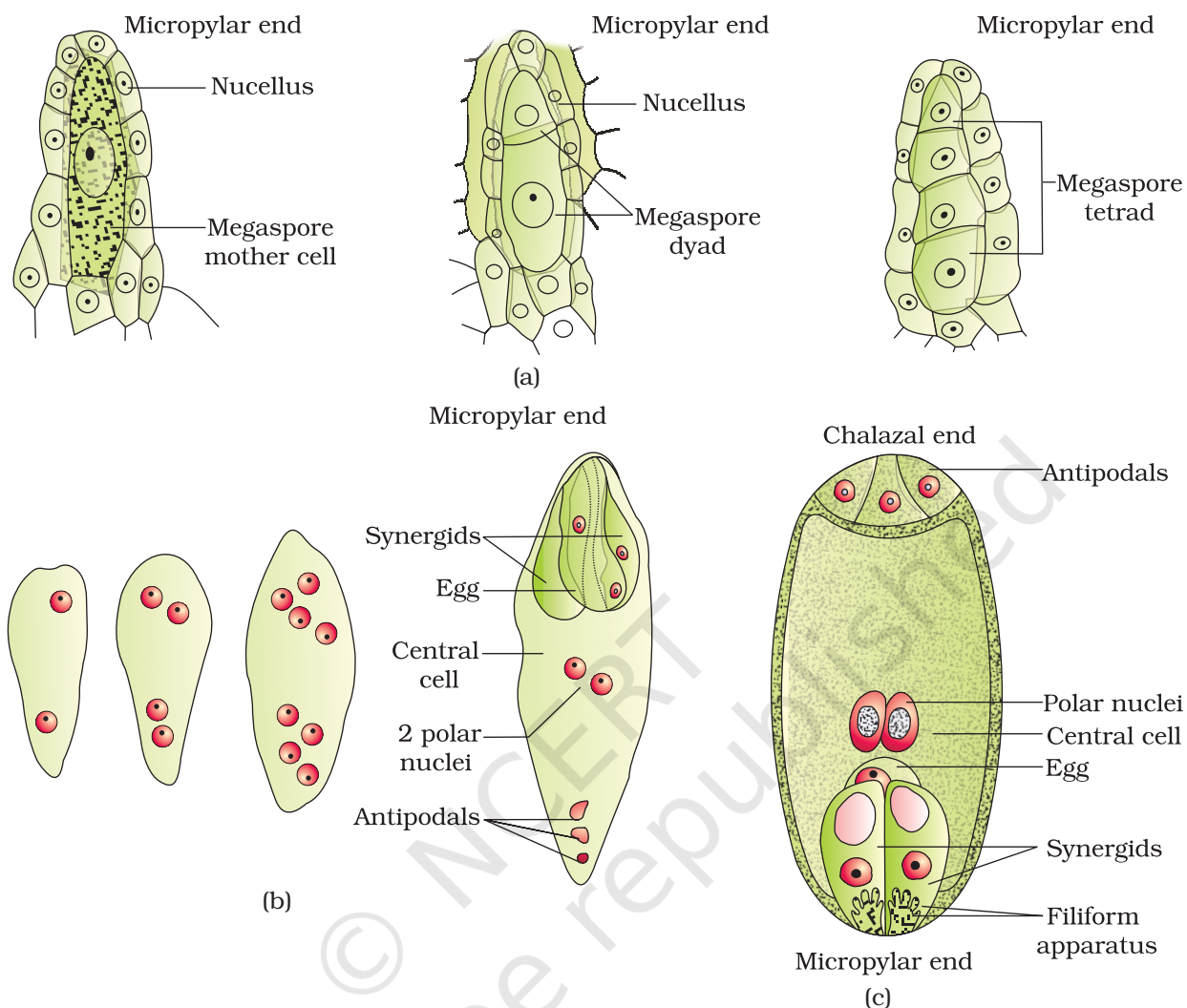
**Figure 1.7** (a) A dissected flower of *Hibiscus* showing pistil (other floral parts have been removed); (b) Multicarpellary, syncarpous pistil of *Papaver*; (c) A multicarpellary, apocarpous gynoecium of *Michelia*; (d) A diagrammatic view of a typical anatropous ovule

Class XI. Arising from the placenta are the **megasporangia**, commonly called **ovules**. The number of ovules in an ovary may be one (wheat, paddy, mango) to many (papaya, water melon, orchids).

**The Megasporangium (Ovule) :** Let us familiarise ourselves with the structure of a typical angiosperm ovule (Figure 1.7d). The ovule is a small structure attached to the placenta by means of a stalk called **funicle**. The body of the ovule fuses with funicle in the region called **hilum**. Thus, hilum represents the junction between ovule and funicle. Each ovule has one or two protective envelopes called **integuments**. Integuments encircle the nucellus except at the tip where a small opening called the **micropyle** is organised. Opposite the micropylar end, is the **chalaza**, representing the basal part of the ovule.

Enclosed within the integuments is a mass of cells called the **nucellus**. Cells of the nucellus have abundant reserve food materials. Located in the nucellus is the **embryo sac** or **female gametophyte**. An ovule generally has a single embryo sac formed from a megaspore.

**Megasporogenesis :** The process of formation of megaspores from the **megaspore mother cell** is called **megasporogenesis**. Ovules generally differentiate a single megaspore mother cell (MMC) in the micropylar region



**Figure 1.8** (a) Parts of the ovule showing a large megaspore mother cell, a dyad and a tetrad of megaspores; (b) 2, 4, and 8-nucleate stages of embryo sac and a mature embryo sac; (c) A diagrammatic representation of the mature embryo sac.

of the nucellus. It is a large cell containing dense cytoplasm and a prominent nucleus. The MMC undergoes meiotic division. *What is the importance of the MMC undergoing meiosis?* Meiosis results in the production of four **megaspores** (Figure 1.8a).

**Female gametophyte** : In a majority of flowering plants, one of the megaspores is **functional** while the other three degenerate. Only the **functional megaspore** develops into the **female gametophyte (embryo sac)**. This method of embryo sac formation from a single megaspore is termed **monosporic** development. *What will be the ploidy of the cells of the nucellus, MMC, the functional megaspore and female gametophyte?*



Let us study about the formation of the embryo sac in detail. (Figure 1.8b). The nucleus of the functional megaspore divides mitotically to form two nuclei which move to the opposite poles, forming the **2-nucleate** embryo sac. Two more sequential mitotic nuclear divisions result in the formation of the **4-nucleate** and later the **8-nucleate** stages of the embryo sac. It is of interest to note that these mitotic divisions are strictly free nuclear, that is, nuclear divisions are not followed immediately by cell wall formation. After the 8-nucleate stage, cell walls are laid down leading to the organisation of the typical **female gametophyte** or **embryo sac**. Observe the distribution of cells inside the embryo sac (Figure 1.8b, c). Six of the eight nuclei are surrounded by cell walls and organised into cells; the remaining two nuclei, called polar nuclei are situated below the egg apparatus in the large **central cell**.

There is a characteristic distribution of the cells within the embryo sac. Three cells are grouped together at the micropylar end and constitute the **egg apparatus**. The egg apparatus, in turn, consists of two **synergids** and one **egg cell**. The synergids have special cellular thickenings at the micropylar tip called filiform apparatus, which play an important role in guiding the pollen tubes into the synergid. Three cells are at the chalazal end and are called the **antipodals**. The large central cell, as mentioned earlier, has two polar nuclei. Thus, a typical angiosperm embryo sac, at maturity, though **8-nucleate** is **7-celled**.

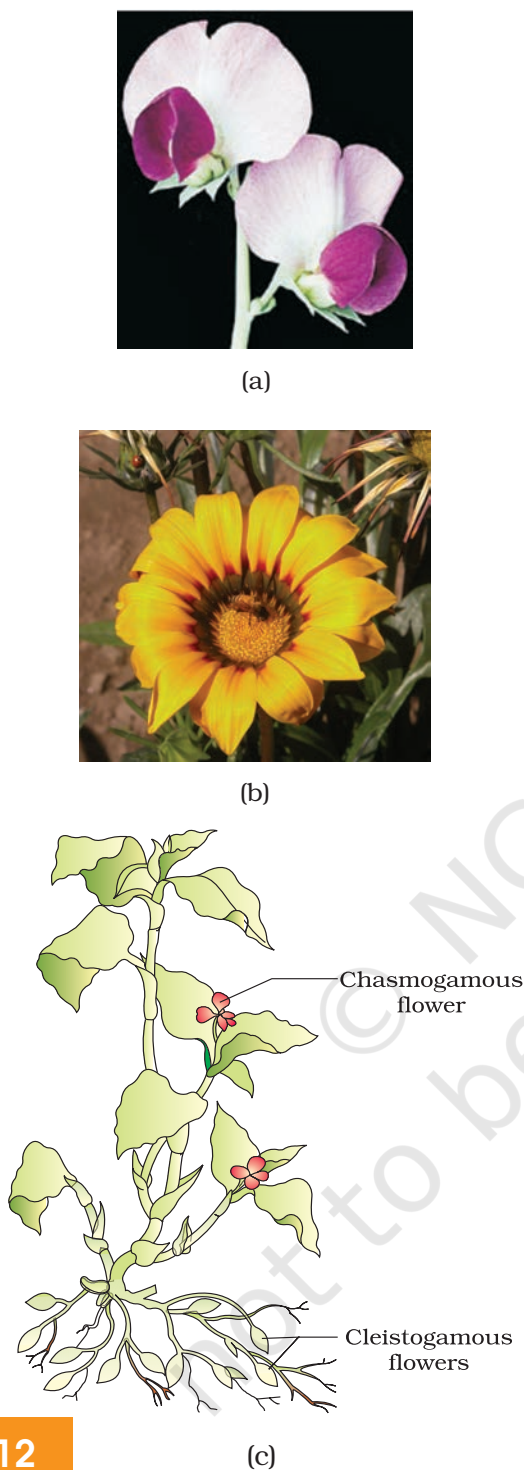
### 1.2.3 Pollination

In the preceding sections you have learnt that the male and female gametes in flowering plants are produced in the pollen grain and embryo sac, respectively. As both types of gametes are non-motile, they have to be brought together for fertilisation to occur. How is this achieved?

**Pollination** is the mechanism to achieve this objective. Transfer of pollen grains (shed from the anther) to the stigma of a pistil is termed **pollination**. Flowering plants have evolved an amazing array of adaptations to achieve pollination. They make use of external agents to achieve pollination. *Can you list the possible external agents?*

**Kinds of Pollination** : Depending on the source of pollen, pollination can be divided into three types.

- (i) **Autogamy** : In this type, pollination is achieved within the same flower. Transfer of pollen grains from the anther to the stigma of the same flower (Figure 1.9a). In a normal flower which opens and exposes the anthers and the stigma, complete autogamy is rather rare. Autogamy in such flowers requires synchrony in pollen release and stigma receptivity and also, the anthers and the stigma should



**Figure 1.9** (a) Self-pollinated flowers;  
(b) Cross pollinated flowers;  
(c) Cleistogamous flowers

lie close to each other so that self-pollination can occur. Some plants such as *Viola* (common pansy), *Oxalis*, and *Commelina* produce two types of flowers – **chasmogamous** flowers which are similar to flowers of other species with exposed anthers and stigma, and **cleistogamous** flowers which do not open at all (Figure 1.9c). In such flowers, the anthers and stigma lie close to each other. When anthers dehisce in the flower buds, pollen grains come in contact with the stigma to effect pollination. Thus, cleistogamous flowers are invariably autogamous as there is no chance of cross-pollen landing on the stigma. Cleistogamous flowers produce assured seed-set even in the absence of pollinators. Do you think that cleistogamy is advantageous or disadvantageous to the plant? Why?

- (ii) **Geitonogamy** – Transfer of pollen grains from the anther to the stigma of another flower of the same plant. Although geitonogamy is functionally cross-pollination involving a pollinating agent, genetically it is similar to autogamy since the pollen grains come from the same plant.
- (iii) **Xenogamy** – Transfer of pollen grains from anther to the stigma of a different plant (Figure 1.9b). This is the only type of pollination which during pollination brings genetically different types of pollen grains to the stigma.

**Agents of Pollination :** Plants use two abiotic (wind and water) and one biotic (animals) agents to achieve pollination. Majority of plants use biotic agents for pollination. Only a small proportion of plants use abiotic agents. Pollen grains coming in contact with the stigma is a chance factor in both wind and water pollination. To compensate for this uncertainties and associated loss of pollen grains, the flowers produce enormous amount of pollen when compared to the number of ovules available for pollination.

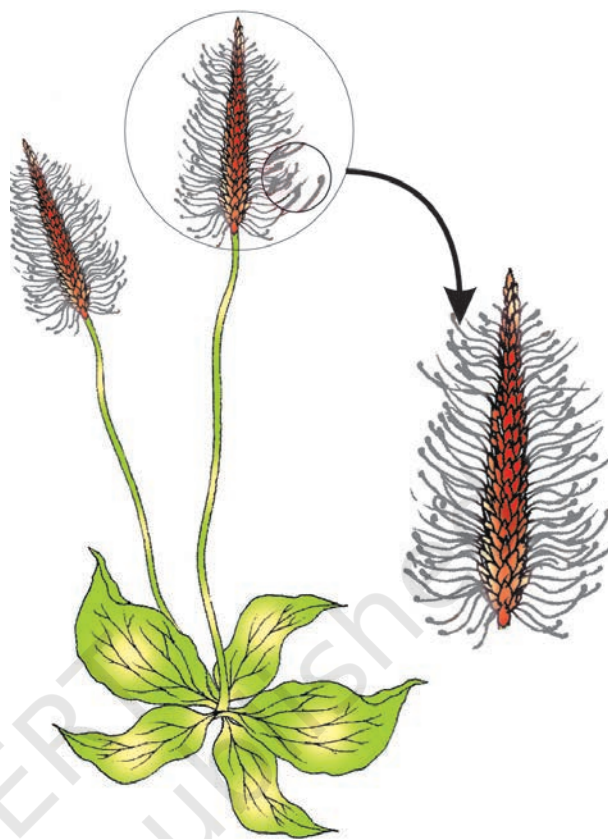




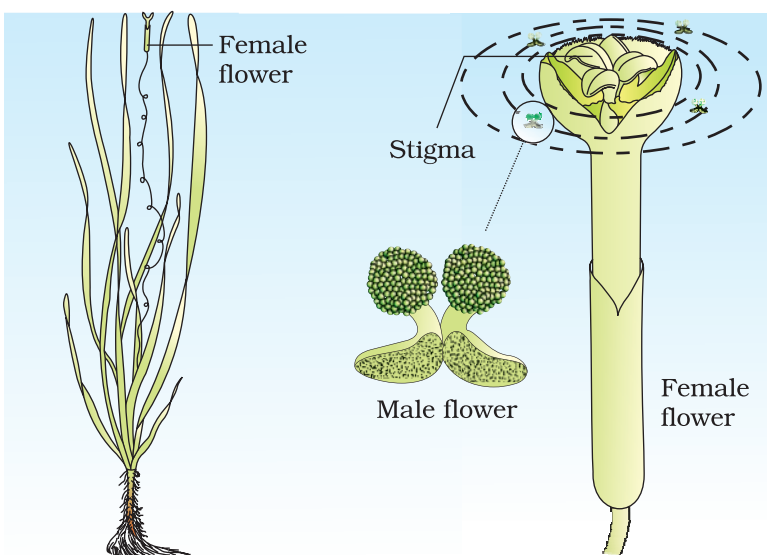
Pollination by wind is more common amongst abiotic pollinations. Wind pollination also requires that the pollen grains are light and non-sticky so that they can be transported in wind currents. They often possess well-exposed stamens (so that the pollens are easily dispersed into wind currents, Figure 1.10) and large often-feathery stigma to easily trap air-borne pollen grains. Wind-pollinated flowers often have a single ovule in each ovary and numerous flowers packed into an inflorescence; a familiar example is the corn cob – the tassels you see are nothing but the stigma and style which wave in the wind to trap pollen grains. Wind-pollination is quite common in grasses.

Pollination by water is quite rare in flowering plants and is limited to about 30 genera, mostly monocotyledons. As against this, you would recall that water is a regular mode of transport for the male gametes among the lower plant groups such as algae, bryophytes and pteridophytes. It is believed, particularly for some bryophytes and pteridophytes, that their distribution is limited because of the need for water for the transport of male gametes and fertilisation. Some examples of water pollinated plants are *Vallisneria* and *Hydrilla* which grow in fresh water and several marine sea-grasses such as *Zostera*. Not all aquatic plants use water for pollination. In a majority of aquatic plants such as water hyacinth and water lily, the flowers emerge above the level of water and are pollinated by insects or wind as in most of the land plants. In *Vallisneria*, the female flower reach the surface of water by the long stalk and the male flowers or pollen grains are released on to the surface of water. They are carried passively by water currents (Figure 1.11a); some of them eventually reach the female flowers and the stigma. In another group of water pollinated plants such as seagrasses, female flowers remain submerged in water and the pollen grains are released inside the water. Pollen grains in many such species are long, ribbon like and they are carried passively inside the water; some of them reach the stigma and achieve pollination. In most of the water-pollinated species, pollen grains are protected from wetting by a mucilaginous covering.

Both wind and water pollinated flowers are not very colourful and do not produce nectar. *What would be the reason for this?*



**Figure 1.10** A wind-pollinated plant showing compact inflorescence and well-exposed stamens



(a)



(b)

**Figure 1.11** (a) Pollination by water in *Vallisneria*;  
(b) Insect pollination

Majority of flowering plants use a range of animals as pollinating agents. Bees, butterflies, flies, beetles, wasps, ants, moths, birds (sunbirds and humming birds) and bats are the common pollinating agents. (Figure 1.11b). Among the animals, insects, particularly bees are the dominant biotic pollinating agents. Even larger animals such as some primates (lemurs), arboreal (tree-dwelling) rodents, or even reptiles (gecko lizard and garden lizard) have also been reported as pollinators in some species.

Often flowers of animal-pollinated plants are specifically adapted for a particular species of animal.

Majority of insect-pollinated flowers are large, colourful, fragrant and rich in nectar. When the flowers are small, a number of flowers are clustered into an inflorescence to make them conspicuous. Animals are attracted to flowers by colour and/or fragrance. The flowers pollinated by flies and beetles secrete foul odours to attract these animals. To sustain animal visits, the flowers have to provide rewards to the animals. Nectar and pollen grains are the usual floral rewards. For harvesting the reward(s) from the flower the animal visitor comes in contact with the anthers and the stigma. The body of the animal gets a coating of pollen grains, which are

generally sticky in animal pollinated flowers. When the animal carrying pollen on its body comes in contact with the stigma, it brings about pollination.

In some species floral rewards are in providing safe places to lay eggs; an example is that of the tallest flower of *Amorphophallus* (the flower itself is about 6 feet in height). A similar relationship exists between a species of moth and the plant *Yucca* where both species – moth and the

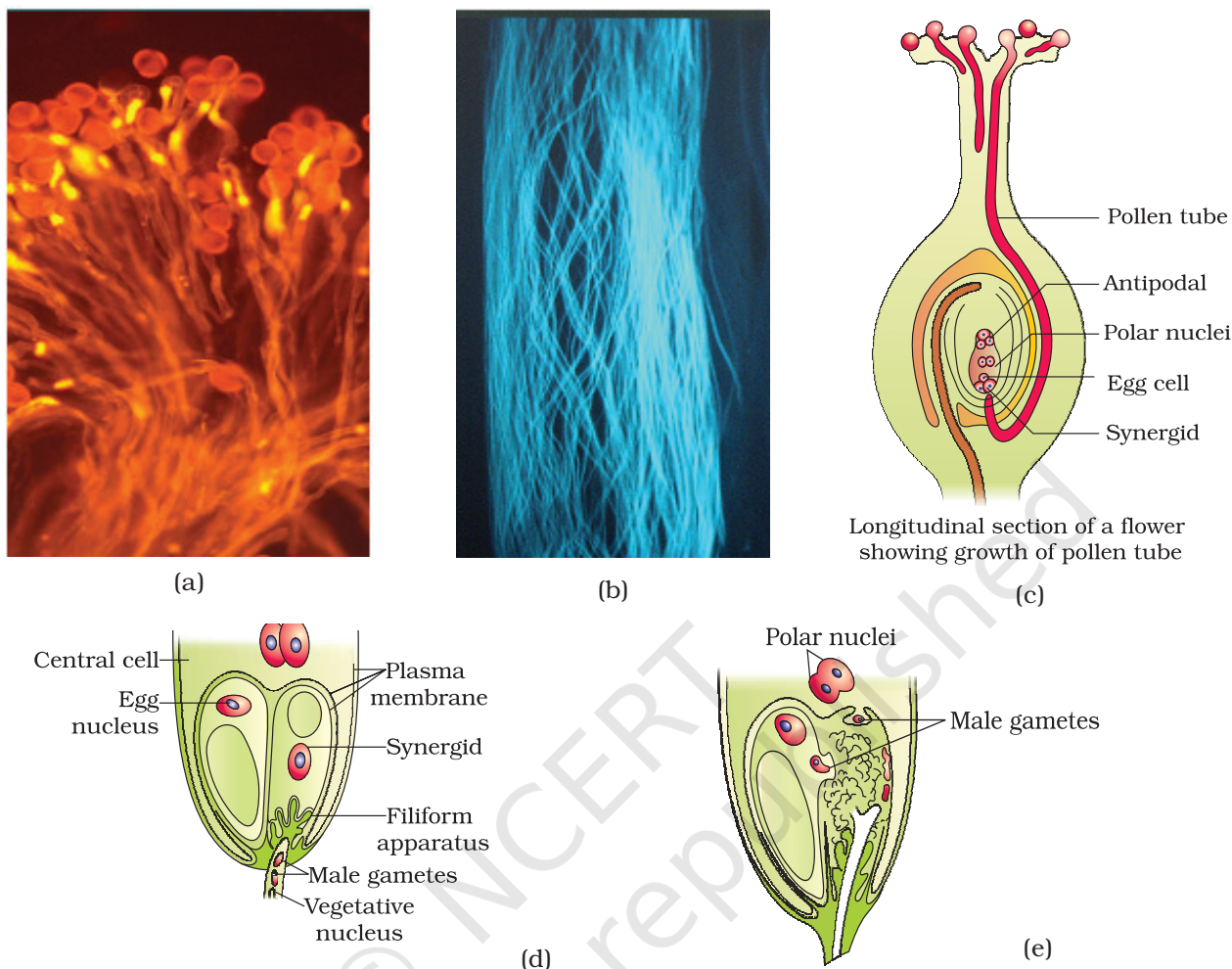


plant – cannot complete their life cycles without each other. The moth deposits its eggs in the locule of the ovary and the flower, in turn, gets pollinated by the moth. The larvae of the moth come out of the eggs as the seeds start developing.

*Why don't you observe some flowers of the following plants (or any others available to you): Cucumber, Mango, Peepal, Coriander, Papaya, Onion, Lobia, Cotton, Tobacco, Rose, Lemon, Eucalyptus, Banana? Try to find out which animals visit them and whether they could be pollinators. You'll have to patiently observe the flowers over a few days and at different times of the day. You could also try to see whether there is any correlation in the characteristics of a flower to the animal that visits it. Carefully observe if any of the visitors come in contact with the anthers and the stigma as only such visitors can bring about pollination. Many insects may consume pollen or the nectar without bringing about pollination. Such floral visitors are referred to as pollen/nectar robbers. You may or may not be able to identify the pollinators, but you will surely enjoy your efforts!*

**Outbreeding Devices :** Majority of flowering plants produce hermaphrodite flowers and pollen grains are likely to come in contact with the stigma of the same flower. Continued self-pollination result in inbreeding depression. Flowering plants have developed many devices to discourage self-pollination and to encourage cross-pollination. In some species, pollen release and stigma receptivity are not synchronised. Either the pollen is released before the stigma becomes receptive or stigma becomes receptive much before the release of pollen. In some other species, the anther and stigma are placed at different positions so that the pollen cannot come in contact with the stigma of the same flower. Both these devices prevent autogamy. The third device to prevent inbreeding is self-incompatibility. This is a genetic mechanism and prevents self-pollen (from the same flower or other flowers of the same plant) from fertilising the ovules by inhibiting pollen germination or pollen tube growth in the pistil. Another device to prevent self-pollination is the production of unisexual flowers. If both male and female flowers are present on the same plant such as castor and maize (monoecious), it prevents autogamy but not geitonogamy. In several species such as papaya, male and female flowers are present on different plants, that is each plant is either male or female (dioecy). This condition prevents both autogamy and geitonogamy.

**Pollen-pistil Interaction :** Pollination does not guarantee the transfer of the right type of pollen (compatible pollen of the same species as the stigma). Often, pollen of the wrong type, either from other species or from the same plant (if it is self-incompatible), also land on the stigma. The pistil has the ability to recognise the pollen, whether it is of the right type (compatible) or of the wrong type (incompatible). If it is of the right type, the pistil accepts the pollen and promotes post-pollination events that



**Figure 1.12** (a) Pollen grains germinating on the stigma; (b) Pollen tubes growing through the style; (c) L.S. of pistil showing path of pollen tube growth; (d) enlarged view of an egg apparatus showing entry of pollen tube into a synergid; (e) Discharge of male gametes into a synergid and the movements of the sperms, one into the egg and the other into the central cell

leads to fertilisation. If the pollen is of the wrong type, the pistil rejects the pollen by preventing pollen germination on the stigma or the pollen tube growth in the style. The ability of the pistil to recognise the pollen followed by its acceptance or rejection is the result of a continuous dialogue between pollen grain and the pistil. This dialogue is mediated by chemical components of the pollen interacting with those of the pistil. It is only in recent years that botanists have been able to identify some of the pollen and pistil components and the interactions leading to the recognition, followed by acceptance or rejection.

As mentioned earlier, following compatible pollination, the pollen grain germinates on the stigma to produce a pollen tube through one of the germ pores (Figure 1.12a). The contents of the pollen grain move into the



pollen tube. Pollen tube grows through the tissues of the stigma and style and reaches the ovary (Figure 1.12b, c). You would recall that in some plants, pollen grains are shed at two-celled condition (a vegetative cell and a generative cell). In such plants, the generative cell divides and forms the two male gametes during the growth of pollen tube in the stigma. In plants which shed pollen in the three-celled condition, pollen tubes carry the two male gametes from the beginning. Pollen tube, after reaching the ovary, enters the ovule through the micropyle and then enters one of the synergids through the filiform apparatus (Figure 1.12d, e). Many recent studies have shown that filiform apparatus present at the micropylar part of the synergids guides the entry of pollen tube. All these events—from pollen deposition on the stigma until pollen tubes enter the ovule—are together referred to as pollen-pistil interaction. As pointed out earlier, pollen-pistil interaction is a dynamic process involving pollen recognition followed by promotion or inhibition of the pollen. The knowledge gained in this area would help the plant breeder in manipulating pollen-pistil interaction, even in incompatible pollinations, to get desired hybrids.

You can easily study pollen germination by dusting some pollen from flowers such as pea, chickpea, *Crotalaria*, balsam and *Vinca* on a glass slide containing a drop of sugar solution (about 10 per cent). After about 15–30 minutes, observe the slide under the low power lens of the microscope. You are likely to see pollen tubes coming out of the pollen grains.

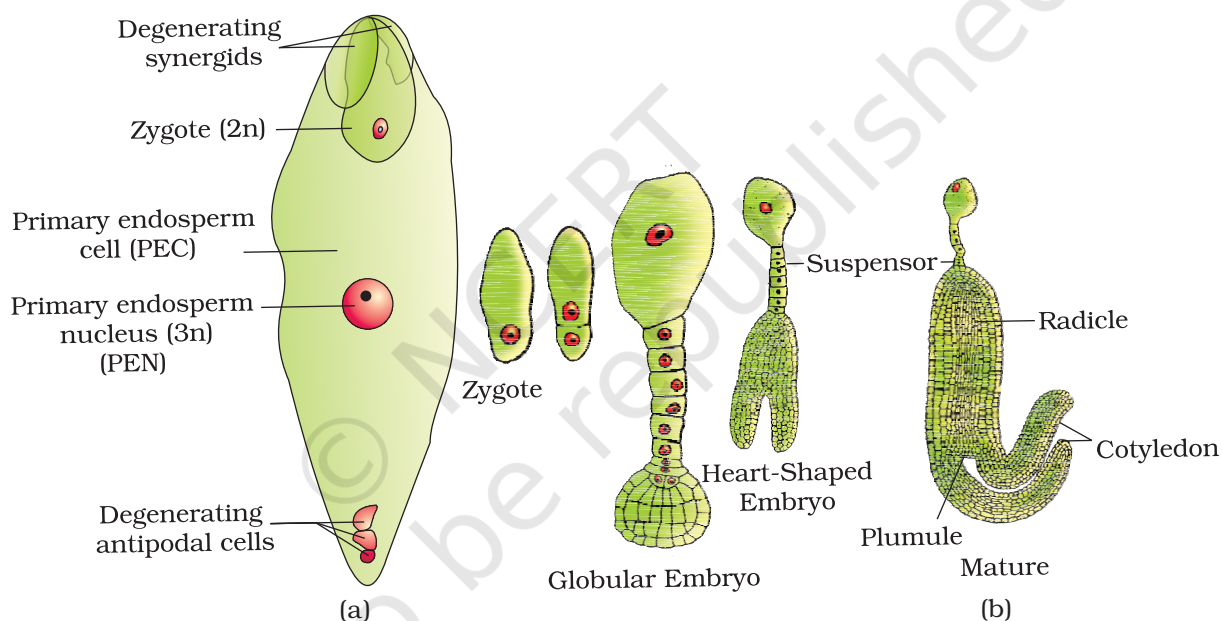
A breeder is interested in crossing different species and often genera to combine desirable characters to produce commercially 'superior' varieties. **Artificial hybridisation** is one of the major approaches of crop improvement programme. In such crossing experiments it is important to make sure that only the desired pollen grains are used for pollination and the stigma is protected from contamination (from unwanted pollen). This is achieved by emasculation and bagging techniques.

If the female parent bears bisexual flowers, removal of anthers from the flower bud before the anther dehisces using a pair of forceps is necessary. This step is referred to as **emasculation**. Emasculated flowers have to be covered with a bag of suitable size, generally made up of butter paper, to prevent contamination of its stigma with unwanted pollen. This process is called **bagging**. When the stigma of bagged flower attains receptivity, mature pollen grains collected from anthers of the male parent are dusted on the stigma, and the flowers are rebagged, and the fruits allowed to develop.

If the female parent produces unisexual flowers, there is no need for emasculation. The female flower buds are bagged before the flowers open. When the stigma becomes receptive, pollination is carried out using the desired pollen and the flower rebagged.

### 1.3 DOUBLE FERTILISATION

After entering one of the synergids, the pollen tube releases the two male gametes into the cytoplasm of the synergid. One of the male gametes moves towards the egg cell and fuses with its nucleus thus completing the **syngamy**. This results in the formation of a diploid cell, the **zygote**. The other male gamete moves towards the two polar nuclei located in the central cell and fuses with them to produce a triploid **primary endosperm nucleus** (PEN) (Figure 1.13a). As this involves the fusion of three haploid nuclei it is termed **triple fusion**. Since two types of fusions, syngamy and triple fusion take place in an embryo sac the phenomenon is termed **double fertilisation**, an event unique to flowering plants. The central cell after triple fusion becomes the **primary endosperm cell** (PEC) and develops into the **endosperm** while the zygote develops into an **embryo**.



**Figure 1.13** (a) Fertilised embryo sac showing zygote and Primary Endosperm Nucleus (PEN); (b) Stages in embryo development in a dicot [shown in reduced size as compared to (a)]

### 1.4 POST-FERTILISATION : STRUCTURES AND EVENTS

Following double fertilisation, events of endosperm and embryo development, maturation of ovule(s) into seed(s) and ovary into fruit, are collectively termed **post-fertilisation events**.

#### 1.4.1 Endosperm

Endosperm development precedes embryo development. *Why?* The primary endosperm cell divides repeatedly and forms a triploid



endosperm tissue. The cells of this tissue are filled with reserve food materials and are used for the nutrition of the developing embryo. In the most common type of endosperm development, the PEN undergoes successive nuclear divisions to give rise to free nuclei. This stage of endosperm development is called free-nuclear endosperm. Subsequently cell wall formation occurs and the endosperm becomes cellular. The number of free nuclei formed before cellularisation varies greatly. The coconut water from tender coconut that you are familiar with, is nothing but free-nuclear endosperm (made up of thousands of nuclei) and the surrounding white kernel is the cellular endosperm.

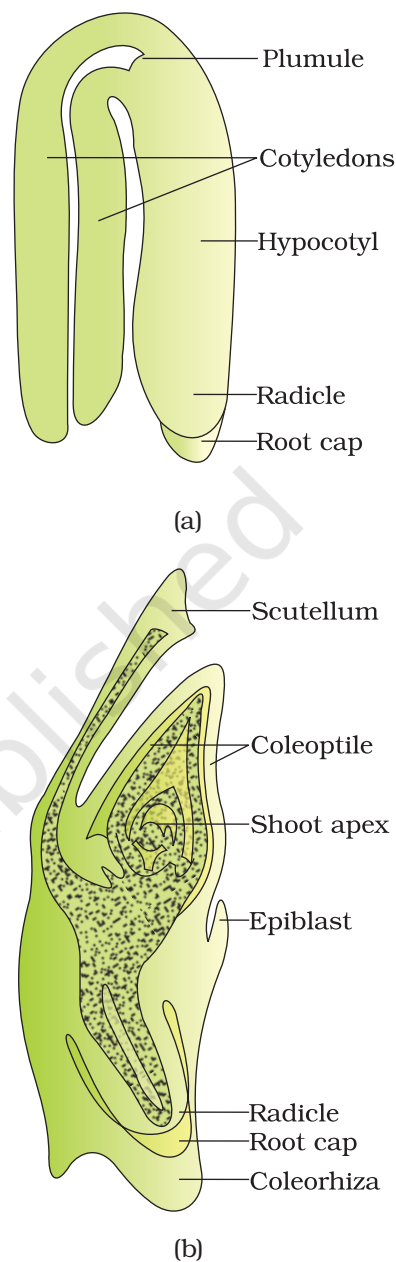
Endosperm may either be completely consumed by the developing embryo (e.g., pea, groundnut, beans) before seed maturation or it may persist in the mature seed (e.g. castor and coconut) and be used up during seed germination. *Split open some seeds of castor, peas, beans, groundnut, fruit of coconut and look for the endosperm in each case. Find out whether the endosperm is persistent in cereals – wheat, rice and maize.*

### 1.4.2 Embryo

Embryo develops at the micropylar end of the embryo sac where the zygote is situated. Most zygotes divide only after certain amount of endosperm is formed. This is an adaptation to provide assured nutrition to the developing embryo. Though the seeds differ greatly, the early stages of embryo development (**embryogeny**) are similar in both monocotyledons and dicotyledons. Figure 1.13 depicts the stages of embryogeny in a dicotyledonous embryo. The zygote gives rise to the **proembryo** and subsequently to the **globular, heart-shaped** and **mature embryo**.

A typical dicotyledonous embryo (Figure 1.14a), consists of an **embryonal axis** and two **cotyledons**. The portion of embryonal axis above the level of cotyledons is the **epicotyl**, which terminates with the **plumule** or stem tip. The cylindrical portion below the level of cotyledons is **hypocotyl** that terminates at its lower end in the **radicle** or **root tip**. The root tip is covered with a **root cap**.

Embryos of monocotyledons (Figure 1.14 b) possess only one cotyledon. In the grass family the cotyledon is called **scutellum** that is situated towards one side (lateral) of the embryonal axis. At its lower end, the embryonal axis has the



**Figure 1.14** (a) A typical dicot embryo; (b) L.S. of an embryo of grass



radical and root cap enclosed in an undifferentiated sheath called **coleorrhiza**. The portion of the embryonal axis above the level of attachment of scutellum is the epicotyl. Epicotyl has a shoot apex and a few leaf primordia enclosed in a hollow foliar structure, the **coleoptile**.

*Soak a few seeds in water (say of wheat, maize, peas, chickpeas, ground nut) overnight. Then split the seeds and observe the various parts of the embryo and the seed.*

### 1.4.3 Seed

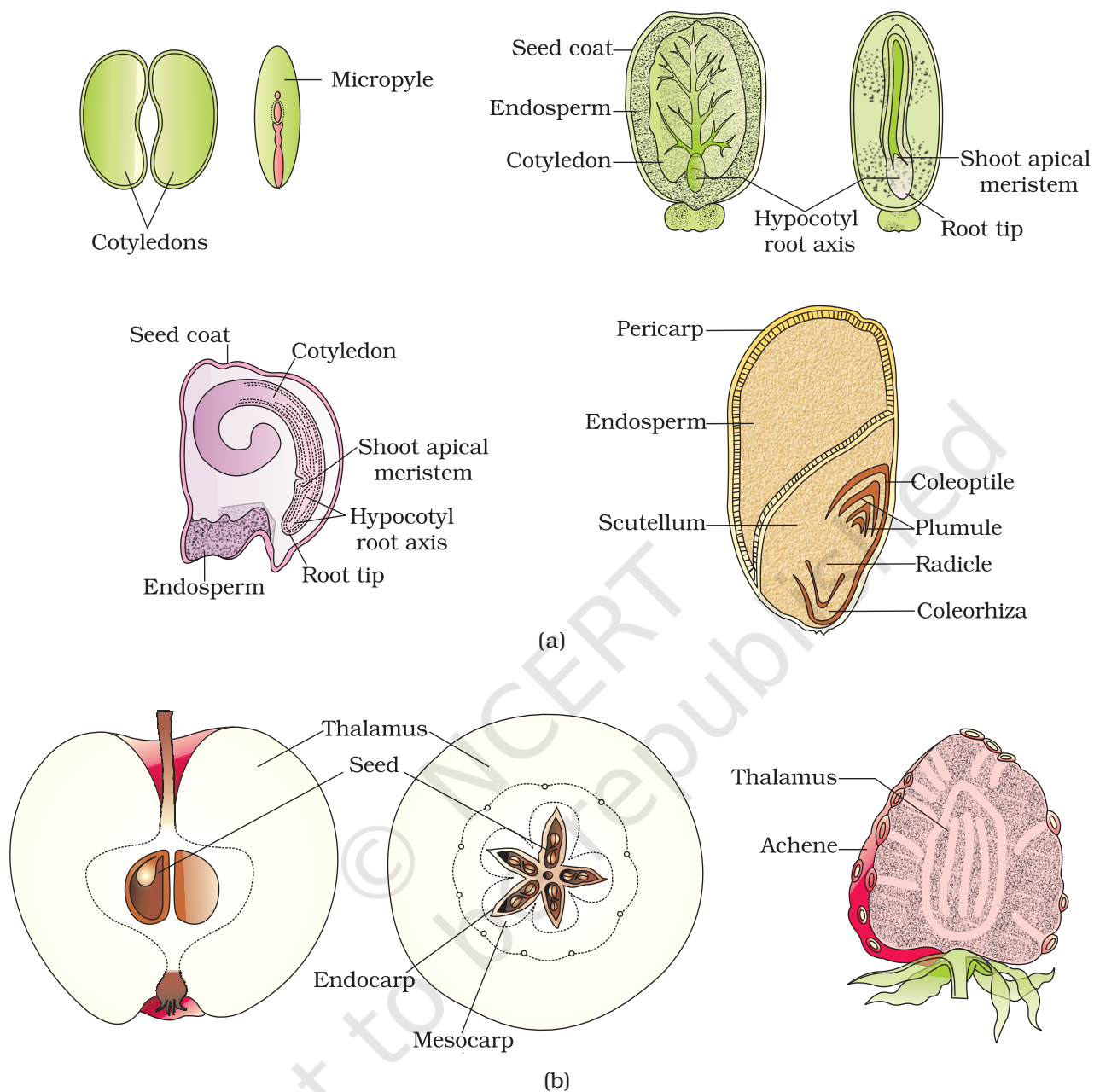
In angiosperms, the seed is the final product of sexual reproduction. It is often described as a fertilised ovule. Seeds are formed inside fruits. A seed typically consists of seed coat(s), cotyledon(s) and an embryo axis. The cotyledons (Figure 1.15a) of the embryo are simple structures, generally thick and swollen due to storage of food reserves (as in legumes). Mature seeds may be **non-albuminous** or **ex-albuminous**. Non-albuminous seeds have no residual endosperm as it is completely consumed during embryo development (e.g., pea, groundnut). Albuminous seeds retain a part of endosperm as it is not completely used up during embryo development (e.g., wheat, maize, barley, castor). Occasionally, in some seeds such as black pepper and beet, remnants of nucellus are also persistent. This residual, persistent nucellus is the **perisperm**.

Integuments of ovules harden as tough protective seed coats (Figure 1.15a). The micropyle remains as a small pore in the seed coat. This facilitates entry of oxygen and water into the seed during germination. As the seed matures, its water content is reduced and seeds become relatively dry (10-15 per cent moisture by mass). The general metabolic activity of the embryo slows down. The embryo may enter a state of inactivity called **dormancy**, or if favourable conditions are available (adequate moisture, oxygen and suitable temperature), they germinate.

As ovules mature into seeds, the ovary develops into a fruit, i.e., the transformation of ovules into seeds and ovary into fruit proceeds simultaneously. The wall of the ovary develops into the wall of fruit called **pericarp**. The fruits may be fleshy as in guava, orange, mango, etc., or may be dry, as in groundnut, and mustard, etc. Many fruits have evolved mechanisms for dispersal of seeds. Recall the classification of fruits and their dispersal mechanisms that you have studied in an earlier class. *Is there any relationship between number of ovules in an ovary and the number of seeds present in a fruit?*

In most plants, by the time the fruit develops from the ovary, other floral parts degenerate and fall off. However, in a few species such as apple, strawberry, cashew, etc., the thalamus also contributes to fruit formation. Such fruits are called **false fruits** (Figure 1.15b). Most fruits however develop only from the ovary and are called **true fruits**. Although in most of the species, fruits are the results of fertilisation, there are a few species





**Figure 1.15** (a) Structure of some seeds. (b) False fruits of apple and strawberry

in which fruits develop without fertilisation. Such fruits are called **parthenocarpic fruits**. Banana is one such example. Parthenocarpy can be induced through the application of growth hormones and such fruits are seedless.

Seeds offer several advantages to angiosperms. Firstly, since reproductive processes such as pollination and fertilisation are independent of water, seed formation is more dependable. Also seeds have better adaptive strategies for dispersal to new habitats and help the species



to colonise in other areas. As they have sufficient food reserves, young seedlings are nourished until they are capable of photosynthesis on their own. The hard seed coat provides protection to the young embryo. Being products of sexual reproduction, they generate new genetic combinations leading to variations.

Seed is the basis of our agriculture. Dehydration and dormancy of mature seeds are crucial for storage of seeds which can be used as food throughout the year and also to raise crop in the next season. Can you imagine agriculture in the absence of seeds, or in the presence of seeds which germinate straight away soon after formation and cannot be stored?

How long do the seeds remain alive after they are dispersed? This period again varies greatly. In a few species the seeds lose viability within a few months. Seeds of a large number of species live for several years. Some seeds can remain alive for hundreds of years. There are several records of very old yet viable seeds. The oldest is that of a lupine, *Lupinus arcticus* excavated from Arctic Tundra. The seed germinated and flowered after an estimated record of 10,000 years of dormancy. A recent record of 2000 years old viable seed is of the date palm, *Phoenix dactylifera* discovered during the archeological excavation at King Herod's palace near the Dead Sea.

*After completing a brief account of sexual reproduction of flowering plants it would be worth attempting to comprehend the enormous reproductive capacity of some flowering plants by asking the following questions: How many eggs are present in an embryo sac? How many embryo sacs are present in an ovule? How many ovules are present in an ovary? How many ovaries are present in a typical flower? How many flowers are present on a tree? And so on...*

*Can you think of some plants in which fruits contain very large number of seeds. Orchid fruits are one such category and each fruit contain thousands of tiny seeds. Similar is the case in fruits of some parasitic species such as *Orobanche* and *Striga*. Have you seen a tiny seed of *Ficus*? How large is the tree of *Ficus* developed from that tiny seed. How many billions of seeds does each *Ficus* tree produce? Can you imagine any other example in which such a tiny structure can produce such a large biomass over the years?*

## 1.5 APOMIXIS AND POLYEMBRYONY

Although seeds, in general are the products of fertilisation, a few flowering plants such as some species of *Asteraceae* and grasses, have evolved a special mechanism, to produce seeds without fertilisation, called **apomixis**. *What is fruit production without fertilisation called?* Thus, apomixis is a form of asexual reproduction that mimics sexual reproduction. There are several ways of development of apomictic seeds. In some species, the diploid egg cell is formed without reduction division and develops into the embryo without fertilisation. More often, as in many *Citrus* and *Mango*



varieties some of the nucellar cells surrounding the embryo sac start dividing, protrude into the embryo sac and develop into the embryos. In such species each ovule contains many embryos. Occurrence of more than one embryo in a seed is referred to as **polyembryony**. *Take out some seeds of orange and squeeze them. Observe the many embryos of different sizes and shapes from each seed. Count the number of embryos in each seed. What would be the genetic nature of apomictic embryos? Can they be called clones?*

Hybrid varieties of several of our food and vegetable crops are being extensively cultivated. Cultivation of hybrids has tremendously increased productivity. One of the problems of hybrids is that hybrid seeds have to be produced every year. If the seeds collected from hybrids are sown, the plants in the progeny will segregate and do not maintain hybrid characters. Production of hybrid seeds is costly and hence the cost of hybrid seeds become too expensive for the farmers. If these hybrids are made into apomicts, there is no segregation of characters in the hybrid progeny. Then the farmers can keep on using the hybrid seeds to raise new crop year after year and he does not have to buy hybrid seeds every year. Because of the importance of apomixis in hybrid seed industry, active research is going on in many laboratories around the world to understand the genetics of apomixis and to transfer apomictic genes into hybrid varieties.

### SUMMARY

Flowers are the seat of sexual reproduction in angiosperms. In the flower, androecium consisting of stamens represents the male reproductive organs and gynoecium consisting of pistils represents the female reproductive organs.

A typical anther is bilobed, ditheous and tetrasporangiate. Pollen grains develop inside the microsporangia. Four wall layers, the epidermis, endothecium, middle layers and the tapetum surround the microsporangium. Cells of the sporogenous tissue lying in the centre of the microsporangium, undergo meiosis (microsporogenesis) to form tetrads of microspores. Individual microspores mature into pollen grains.

Pollen grains represents the male gametophytic generation. The pollen grains have a two-layered wall, the outer exine and inner intine. The exine is made up of sporopollenin and has germ pores. Pollen grains may have two cells (a vegetative cell and generative cell) or three cells (a vegetative cell and two male gametes) at the time of shedding.

The pistil has three parts – the stigma, style and the ovary. Ovules are present in the ovary. The ovules have a stalk called funicle, protective integument(s), and an opening called micropyle. The central tissue is the nucellus in which the archesporium differentiates. A cell of the archesporium, the megaspore mother cell divides meiotically and one of the megaspores forms the embryo sac (the female gametophyte). The mature embryo sac is 7-celled and 8-nucleate. At the micropylar end is



the egg apparatus consisting of two synergids and an egg cell. At the chalazal end are three antipodals. At the centre is a large central cell with two polar nuclei.

Pollination is the mechanism to transfer pollen grains from the anther to the stigma. Pollinating agents are either abiotic (wind and water) or biotic (animals).

Pollen-pistil interaction involves all events from the landing of pollen grains on the stigma until the pollen tube enters the embryo sac (when the pollen is compatible) or pollen inhibition (when the pollen is incompatible). Following compatible pollination, pollen grain germinates on the stigma and the resulting pollen tube grows through the style, enters the ovules and finally discharges two male gametes in one of the synergids. Angiosperms exhibit double fertilisation because two fusion events occur in each embryo sac, namely syngamy and triple fusion. The products of these fusions are the diploid zygote and the triploid primary endosperm nucleus (in the primary endosperm cell). Zygote develops into the embryo and the primary endosperm cell forms the endosperm tissue. Formation of endosperm always precedes development of the embryo.

The developing embryo passes through different stages such as the proembryo, globular and heart-shaped stages before maturation. Mature dicotyledonous embryo has two cotyledons and an embryonal axis with epicotyl and hypocotyl. Embryos of monocotyledons have a single cotyledon. After fertilisation, ovary develops into fruit and ovules develop into seeds.

A phenomenon called apomixis is found in some angiosperms, particularly in grasses. It results in the formation of seeds without fertilisation. Apomicts have several advantages in horticulture and agriculture.

Some angiosperms produce more than one embryo in their seed. This phenomenon is called polyembryony.



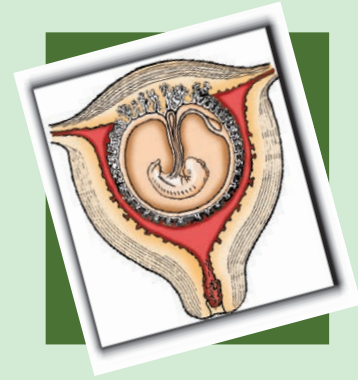
## EXERCISES

1. Name the parts of an angiosperm flower in which development of male and female gametophyte take place.
2. Differentiate between microsporogenesis and megasporogenesis. Which type of cell division occurs during these events? Name the structures formed at the end of these two events.
3. Arrange the following terms in the correct developmental sequence: Pollen grain, sporogenous tissue, microspore tetrad, pollen mother cell, male gametes.
4. With a neat, labelled diagram, describe the parts of a typical angiosperm ovule.
5. What is meant by monosporic development of female gametophyte?
6. With a neat diagram explain the 7-celled, 8-nucleate nature of the female gametophyte.



7. What are chasmogamous flowers? Can cross-pollination occur in cleistogamous flowers? Give reasons for your answer.
  8. Mention two strategies evolved to prevent self-pollination in flowers.
  9. What is self-incompatibility? Why does self-pollination not lead to seed formation in self-incompatible species?
  10. What is bagging technique? How is it useful in a plant breeding programme?
  11. What is triple fusion? Where and how does it take place? Name the nuclei involved in triple fusion.
  12. Why do you think the zygote is dormant for sometime in a fertilised ovule?
  13. Differentiate between:
    - (a) hypocotyl and epicotyl;
    - (b) coleoptile and coleorrhiza;
    - (c) integument and testa;
    - (d) perisperm and pericarp.
  14. Why is apple called a false fruit? Which part(s) of the flower forms the fruit?
  15. What is meant by emasculation? When and why does a plant breeder employ this technique?
  16. If one can induce parthenocarpy through the application of growth substances, which fruits would you select to induce parthenocarpy and why?
  17. Explain the role of tapetum in the formation of pollen-grain wall.
  18. What is apomixis and what is its importance?
- 
-

# CHAPTER 2



# HUMAN REPRODUCTION

- 2.1 *The Male Reproductive System*
- 2.2 *The Female Reproductive System*
- 2.3 *Gametogenesis*
- 2.4 *Menstrual Cycle*
- 2.5 *Fertilisation and Implantation*
- 2.6 *Pregnancy and Embryonic Development*
- 2.7 *Parturition and Lactation*

As you are aware, humans are sexually reproducing and viviparous. The reproductive events in humans include formation of gametes (gametogenesis), i.e., sperms in males and ovum in females, transfer of sperms into the female genital tract (insemination) and fusion of male and female gametes (fertilisation) leading to formation of zygote. This is followed by formation and development of blastocyst and its attachment to the uterine wall (implantation), embryonic development (gestation) and delivery of the baby (parturition). You have learnt that these reproductive events occur after puberty. There are remarkable differences between the reproductive events in the male and in the female, for example, sperm formation continues even in old men, but formation of ovum ceases in women around the age of fifty years. Let us examine the male and female reproductive systems in human.

## 2.1 THE MALE REPRODUCTIVE SYSTEM

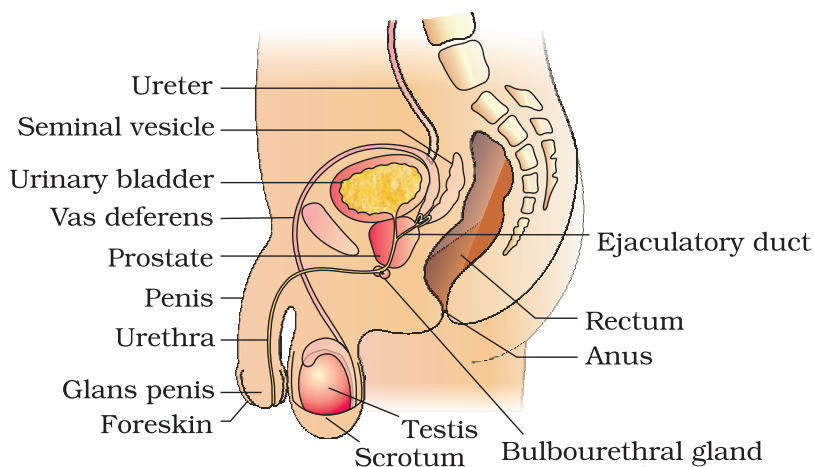
The male reproductive system is located in the pelvis region (Figure 2.1a). It includes a pair of **testes** along with **accessory ducts**, **glands** and the **external genitalia**.



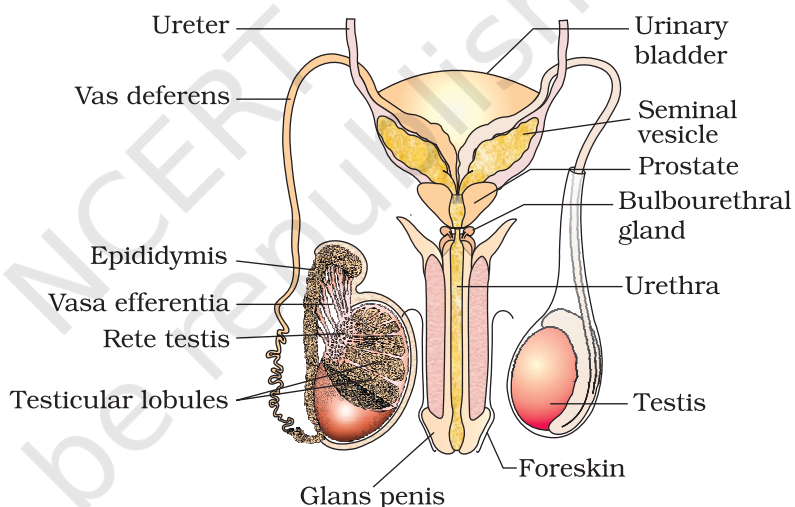
The testes are situated outside the abdominal cavity within a pouch called **scrotum**. The scrotum helps in maintaining the low temperature of the testes (2–2.5° C lower than the normal internal body temperature) necessary for spermatogenesis. In adults, each testis is oval in shape, with a length of about 4 to 5 cm and a width of about 2 to 3 cm. The testis is covered by a dense covering. Each testis has about 250 compartments called **testicular lobules** (Figure 2.1b).

Each lobule contains one to three highly coiled **seminiferous tubules** in which sperms are produced. Each seminiferous tubule is lined on its inside by two types of cells called **male germ cells** (*spermatogonia*) and **Sertoli cells** (Figure 2.2). The male germ cells undergo meiotic divisions finally leading to sperm formation, while Sertoli cells provide nutrition to the germ cells. The regions outside the seminiferous tubules called interstitial spaces, contain small blood vessels and **interstitial cells** or **Leydig cells** (Figure 2.2). Leydig cells synthesise and secrete testicular hormones called androgens. Other immunologically competent cells are also present.

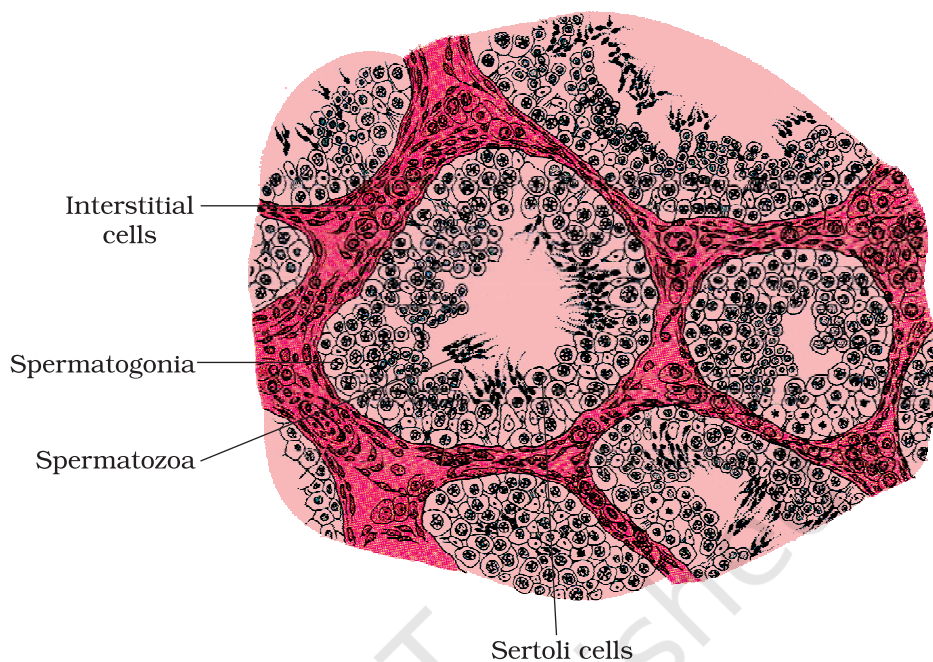
The male sex accessory ducts include **rete testis**, **vasa efferentia**, **epididymis** and **vas deferens** (Figure 2.1b). The seminiferous tubules of the testis open into the vasa efferentia through rete testis. The vasa efferentia leave the testis and open into epididymis located along the posterior surface of each testis. The epididymis leads to vas deferens that ascends to the abdomen and loops over the urinary bladder. It receives a duct from seminal vesicle and opens into urethra as the ejaculatory duct (Figure 2.1a). These ducts store and transport the sperms from the testis to the outside through urethra. The urethra originates from the urinary bladder and extends through the penis to its external opening called **urethral meatus**.



**Figure 2.1(a)** Diagrammatic sectional view of male pelvis showing reproductive system



**Figure 2.1(b)** Diagrammatic view of male reproductive system (part of testis is open to show inner details)



**Figure 2.2** Diagrammatic sectional view of seminiferous tubule

The penis is the male external genitalia (Figure 2.1a, b). It is made up of special tissue that helps in erection of the penis to facilitate insemination. The enlarged end of penis called the glans penis is covered by a loose fold of skin called **foreskin**.

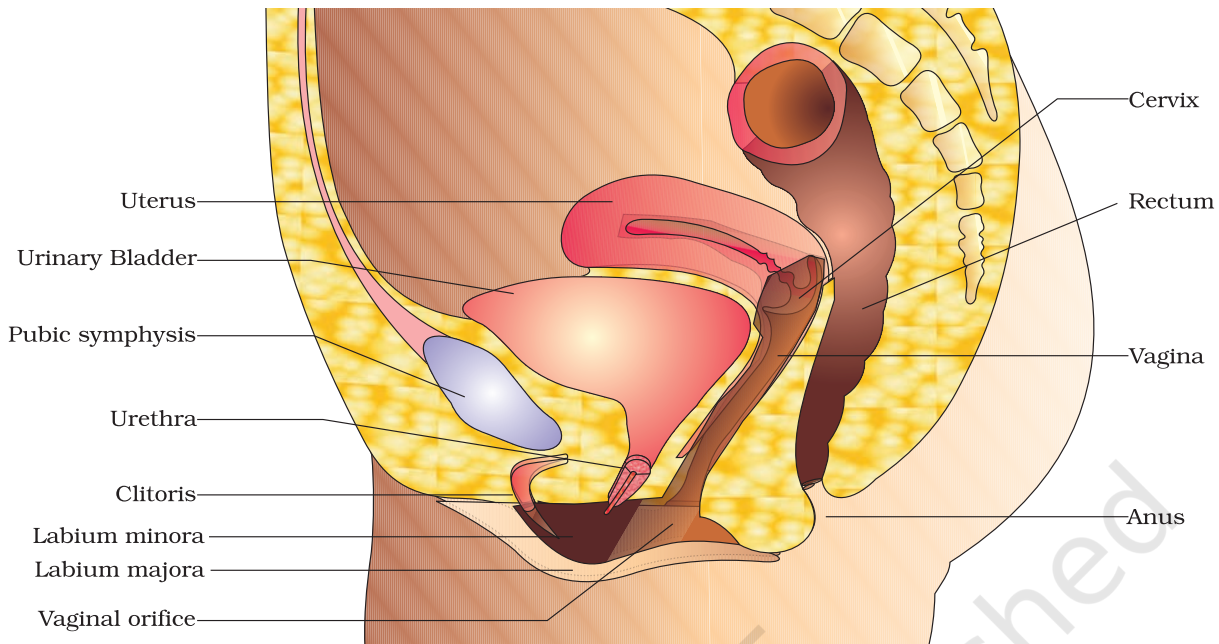
The male accessory glands (Figure 2.1a, b) include paired **seminal vesicles**, a **prostate** and paired **bulbourethral glands**. Secretions of these glands constitute the seminal plasma which is rich in fructose, calcium and certain enzymes. The secretions of bulbourethral glands also helps in the lubrication of the penis.

## 2.2 THE FEMALE REPRODUCTIVE SYSTEM

The female reproductive system consists of a pair of **ovaries** along with a pair of **oviducts**, **uterus**, **cervix**, **vagina** and the **external genitalia** located in pelvic region (Figure 2.3a). These parts of the system along with a pair of the **mammary glands** are integrated structurally and functionally to support the processes of ovulation, fertilisation, pregnancy, birth and child care.

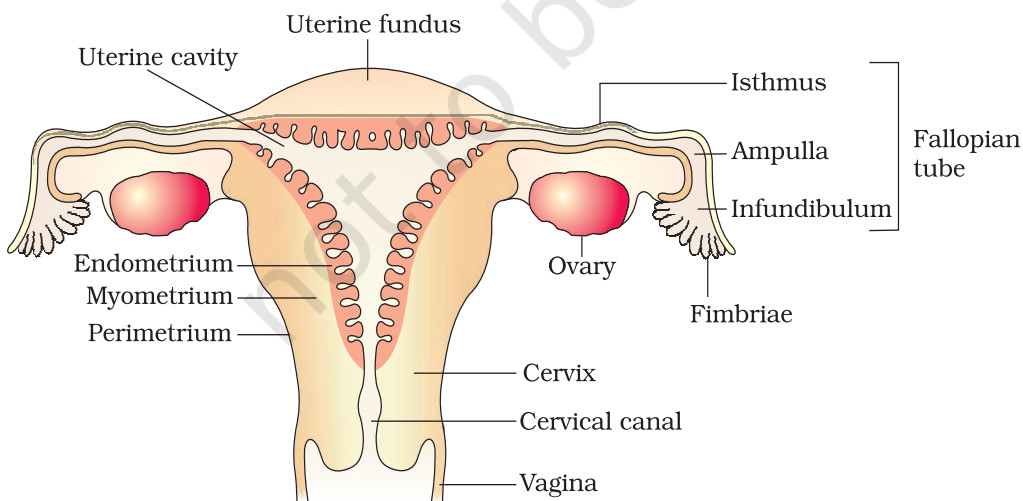
Ovaries are the primary female sex organs that produce the female gamete (ovum) and several steroid hormones (ovarian hormones). The ovaries are located one on each side of the lower abdomen (Figure 2.3b). Each ovary is about 2 to 4 cm in length and is connected to the pelvic wall and uterus by ligaments. Each ovary is covered by a thin epithelium which encloses the ovarian stroma. The stroma is divided into two zones – a peripheral cortex and an inner medulla.





**Figure 2.3 (a)** Diagrammatic sectional view of female pelvis showing reproductive system

The oviducts (fallopian tubes), uterus and vagina constitute the female accessory ducts. Each fallopian tube is about 10-12 cm long and extends from the periphery of each ovary to the uterus (Figure 2.3b), the part closer to the ovary is the funnel-shaped **infundibulum**. The edges of the infundibulum possess finger-like projections called **fimbriae**, which help in collection of the ovum after ovulation. The infundibulum leads to a wider

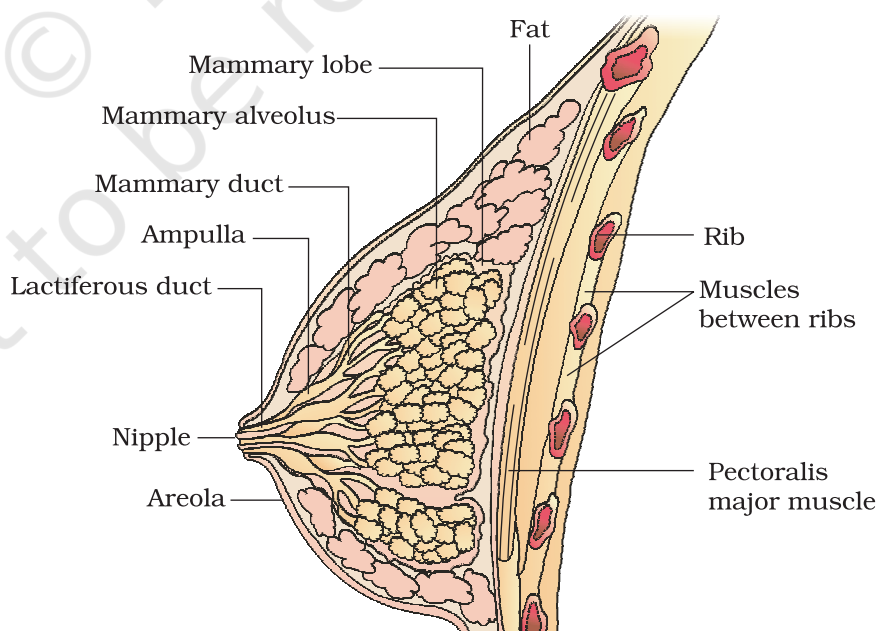


**Figure 2.3 (b)** Diagrammatic sectional view of the female reproductive system

part of the oviduct called **ampulla**. The last part of the oviduct, **isthmus** has a narrow lumen and it joins the uterus.

The uterus is single and it is also called **womb**. The shape of the uterus is like an inverted pear. It is supported by ligaments attached to the pelvic wall. The uterus opens into vagina through a narrow cervix. The cavity of the cervix is called **cervical canal** (Figure 2.3b) which alongwith vagina forms the birth canal. The wall of the uterus has three layers of tissue. The external thin membranous **perimetrium**, middle thick layer of smooth muscle, **myometrium** and inner glandular layer called **endometrium** that lines the uterine cavity. The endometrium undergoes cyclical changes during menstrual cycle while the myometrium exhibits strong contraction during delivery of the baby.

The female external genitalia include mons pubis, labia majora, labia minora, hymen and clitoris (Figure 2.3a). **Mons pubis** is a cushion of fatty tissue covered by skin and pubic hair. The **labia majora** are fleshy folds of tissue, which extend down from the mons pubis and surround the vaginal opening. The **labia minora** are paired folds of tissue under the labia majora. The opening of the vagina is often covered partially by a membrane called **hymen**. The **clitoris** is a tiny finger-like structure which lies at the upper junction of the two labia minora above the urethral opening. The hymen is often torn during the first coitus (intercourse). *However, it can also be broken by a sudden fall or jolt, insertion of a vaginal tampon, active participation in some sports like horseback riding, cycling, etc. In some women the hymen persists even after coitus. In fact, the presence or absence of hymen is not a reliable indicator of virginity or sexual experience.*



**Figure 2.4** A diagrammatic sectional view of Mammary gland

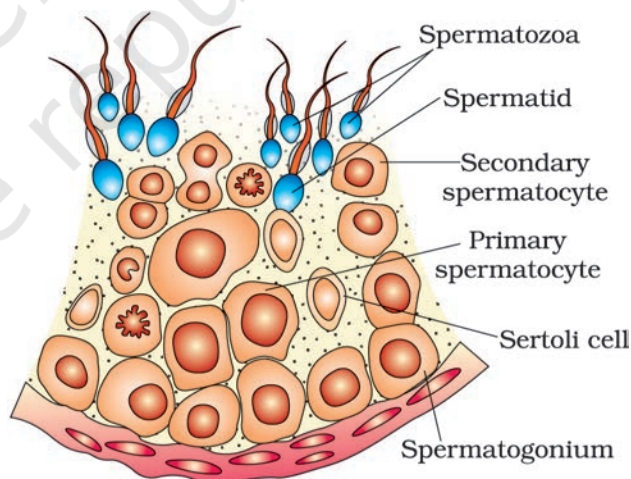


A functional mammary gland is characteristic of all female mammals. The mammary glands are paired structures (breasts) that contain glandular tissue and variable amount of fat. The glandular tissue of each breast is divided into 15-20 **mammary lobes** containing clusters of cells called alveoli (Figure 2.4). The cells of alveoli secrete milk, which is stored in the cavities (lumens) of alveoli. The alveoli open into mammary tubules. The tubules of each lobe join to form a **mammary duct**. Several mammary ducts join to form a wider mammary ampulla which is connected to **lactiferous duct** through which milk is sucked out.

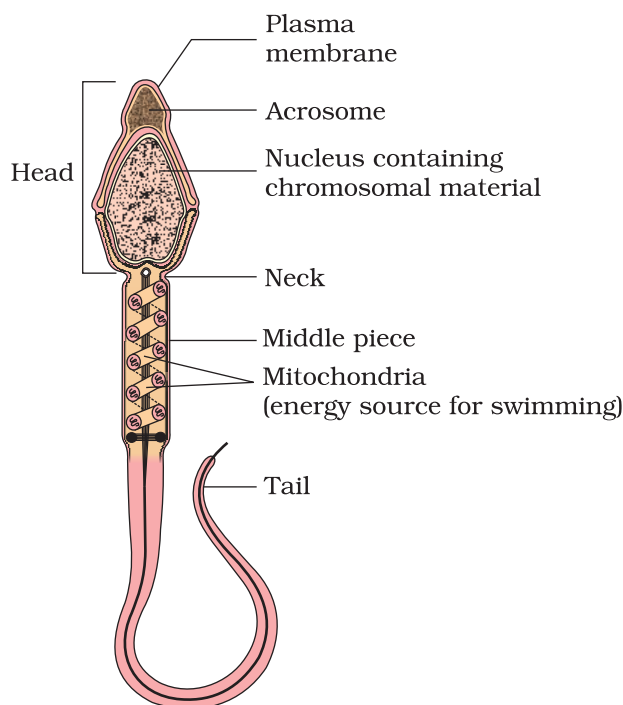
## 2.3 GAMETOGENESIS

The primary sex organs – the testis in the males and the ovaries in the females – produce gametes, i.e, sperms and ovum, respectively, by the process called gametogenesis. In testis, the immature male germ cells (spermatogonia) produce sperms by **spermatogenesis** that begins at puberty. The **spermatogonia** (sing. spermatogonium) present on the inside wall of seminiferous tubules multiply by mitotic division and increase in numbers. Each spermatogonium is diploid and contains 46 chromosomes. Some of the spermatogonia called **primary spermatocytes** periodically undergo meiosis. A primary spermatocyte completes the first meiotic division (reduction division) leading to formation of two equal, haploid cells called **secondary spermatocytes**, which have only 23 chromosomes each. The secondary spermatocytes undergo the second meiotic division to produce four equal, haploid **spermatids** (Figure 2.5). *What would be the number of chromosome in the spermatids?* The spermatids are transformed into **spermatozoa (sperms)** by the process called **spermiogenesis**. After spermiogenesis, sperm heads become embedded in the **Sertoli cells**, and are finally released from the seminiferous tubules by the process called **spermiation**.

Spermatogenesis starts at the age of puberty due to significant increase in the secretion of gonadotropin releasing hormone (GnRH). This, if you recall, is a hypothalamic hormone. The increased levels of GnRH then acts at the anterior pituitary gland and stimulates secretion of two gonadotropins – luteinising hormone (LH) and follicle stimulating hormone (FSH). LH acts at the Leydig cells and stimulates synthesis and secretion of androgens. Androgens, in turn, stimulate the process of spermatogenesis. FSH acts on the Sertoli cells and stimulates



**Figure 2.5** Diagrammatic sectional view of a seminiferous tubule (enlarged)



**Figure 2.6** Structure of a sperm

secretion of some factors which help in the process of spermiogenesis.

Let us examine the structure of a sperm. It is a microscopic structure composed of a **head**, **neck**, a **middle piece** and a **tail** (Figure 2.6). A plasma membrane envelops the whole body of sperm. The sperm head contains an elongated haploid nucleus, the anterior portion of which is covered by a cap-like structure, **acrosome**. The acrosome is filled with enzymes that help fertilisation of the ovum. The middle piece possesses numerous mitochondria, which produce energy for the movement of tail that facilitate sperm motility essential for fertilisation. The human male ejaculates about 200 to 300 million sperms during a coitus of which, for normal fertility, at least 60 per cent sperms must have normal shape and size and at least 40 per cent of them must show vigorous motility.

Sperms released from the seminiferous tubules, are transported by the accessory

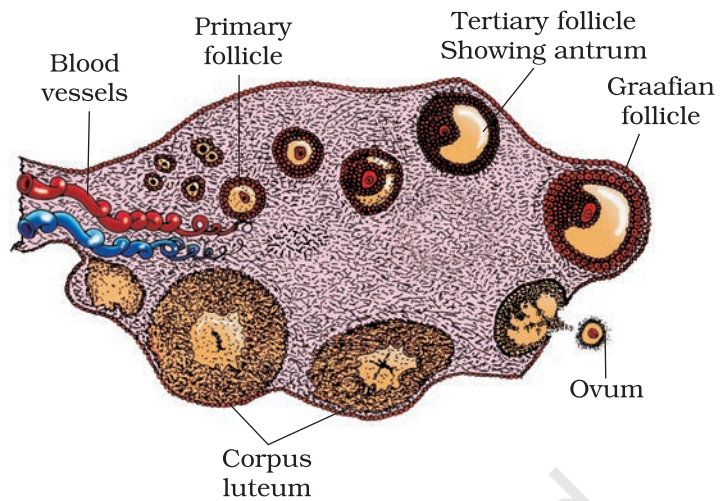
ducts. Secretions of epididymis, vas deferens, seminal vesicle and prostate are essential for maturation and motility of sperms. The seminal plasma along with the sperms constitute the **semen**. The functions of male sex accessory ducts and glands are maintained by the testicular hormones (androgens).

The process of formation of a mature female gamete is called **oogenesis** which is markedly different from spermatogenesis. Oogenesis is initiated during the embryonic development stage when a couple of million gamete mother cells (**oogonia**) are formed within each fetal ovary; no more oogonia are formed and added after birth. These cells start division and enter into prophase-I of the meiotic division and get temporarily arrested at that stage, called **primary oocytes**. Each primary oocyte then gets surrounded by a layer of granulosa cells and is called the **primary follicle** (Figure 2.7). A large number of these follicles degenerate during the phase from birth to puberty. Therefore, at puberty only 60,000-80,000 primary follicles are left in each ovary. The primary follicles get surrounded by more layers of granulosa cells and a new theca and are called **secondary follicles**.

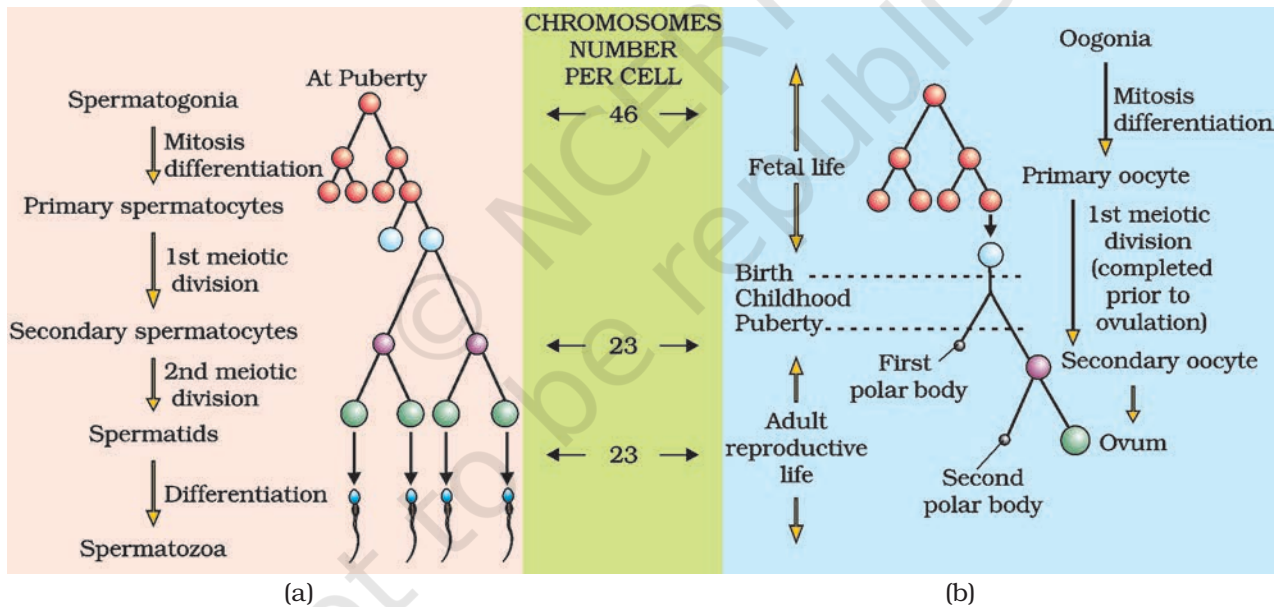
The secondary follicle soon transforms into a tertiary follicle which is characterised by a fluid filled cavity called **antrum**. The theca layer is organised into an inner theca interna and an outer theca externa. It is important to draw your attention that it is at this stage that the primary oocyte within the tertiary follicle grows in size and completes its first meiotic division. It is an unequal division resulting in the formation of a large haploid **secondary oocyte** and a tiny first polar body (Figure 2.8b). The



secondary oocyte retains bulk of the nutrient rich cytoplasm of the primary oocyte. *Can you think of any advantage for this?* Does the first polar body born out of first meiotic division divide further or degenerate? At present we are not very certain about this. The tertiary follicle further changes into the mature follicle or **Graafian follicle** (Figure 2.7). The secondary oocyte forms a new membrane called **zona pellucida** surrounding it. The Graafian follicle now ruptures to release the secondary oocyte (ovum) from the ovary by the process called **ovulation**. *Can you identify major differences between spermatogenesis and oogenesis?* A diagrammatic representation of spermatogenesis and oogenesis is given below (Figure 2.8).



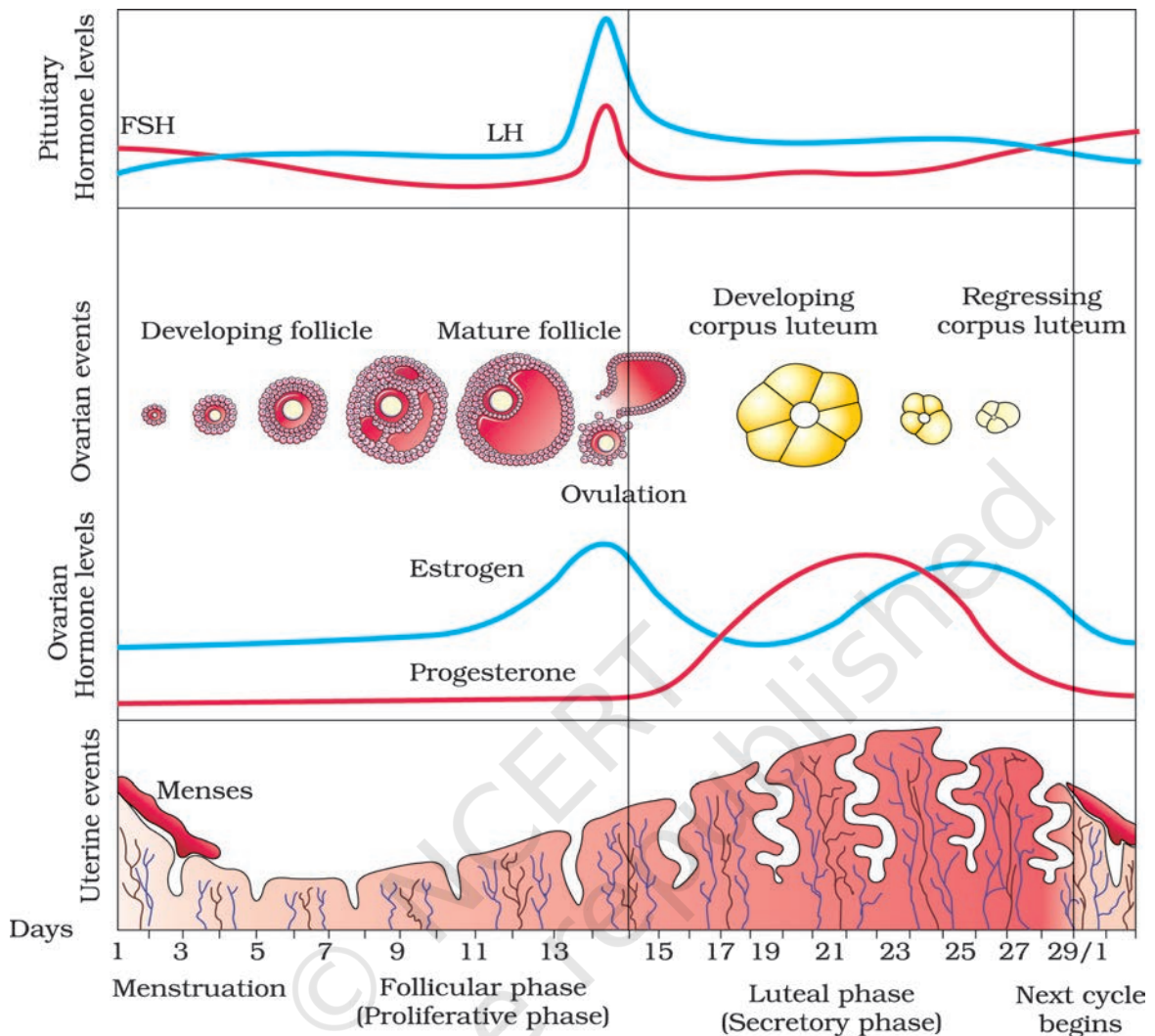
**Figure 2.7** Diagrammatic Section view of ovary



**Figure 2.8** Schematic representation of (a) Spermatogenesis; (b) Oogenesis

## 2.4 MENSTRUAL CYCLE

The reproductive cycle in the female primates (e.g. monkeys, apes and human beings) is called menstrual cycle. The first menstruation begins at puberty and is called **menarche**. In human females, menstruation is repeated at an average interval of about 28/29 days, and the cycle of events starting from one menstruation till the next one is called the **menstrual cycle**. One ovum is released (ovulation) during the middle



**Figure 2.9** Diagrammatic presentation of various events during a menstrual cycle

of each menstrual cycle. The major events of the menstrual cycle are shown in Figure 2.9. The cycle starts with the menstrual phase, when menstrual flow occurs and it lasts for 3-5 days. The menstrual flow results due to breakdown of endometrial lining of the uterus and its blood vessels which forms liquid that comes out through vagina. Menstruation only occurs if the released ovum is not fertilised. Lack of menstruation may be indicative of pregnancy. However, it may also be caused due to some other underlying causes like stress, poor health etc. The menstrual phase is followed by the follicular phase. During this phase, the primary follicles in the ovary grow to become a fully mature Graafian follicle and simultaneously the endometrium of uterus regenerates through proliferation. These changes in the ovary and the uterus are induced by changes in the levels of pituitary and ovarian hormones (Figure 2.9). The secretion of



gonadotropins (LH and FSH) increases gradually during the follicular phase, and stimulates follicular development as well as secretion of estrogens by the growing follicles. Both LH and FSH attain a peak level in the middle of cycle (about 14<sup>th</sup> day). Rapid secretion of LH leading to its maximum level during the mid-cycle called LH surge induces rupture of Graafian follicle and thereby the release of ovum (**ovulation**). The ovulation (ovulatory phase) is followed by the luteal phase during which the remaining parts of the Graafian follicle transform as the **corpus luteum** (Figure 2.9). The corpus luteum secretes large amounts of progesterone which is essential for maintenance of the endometrium. Such an endometrium is necessary for implantation of the fertilised ovum and other events of pregnancy. During pregnancy all events of the menstrual cycle stop and there is no menstruation. In the absence of fertilisation, the corpus luteum degenerates. This causes disintegration of the endometrium leading to menstruation, marking a new cycle. In human beings, menstrual cycles ceases around 50 years of age; that is termed as **menopause**. Cyclic menstruation is an indicator of normal reproductive phase and extends between menarche and menopause.

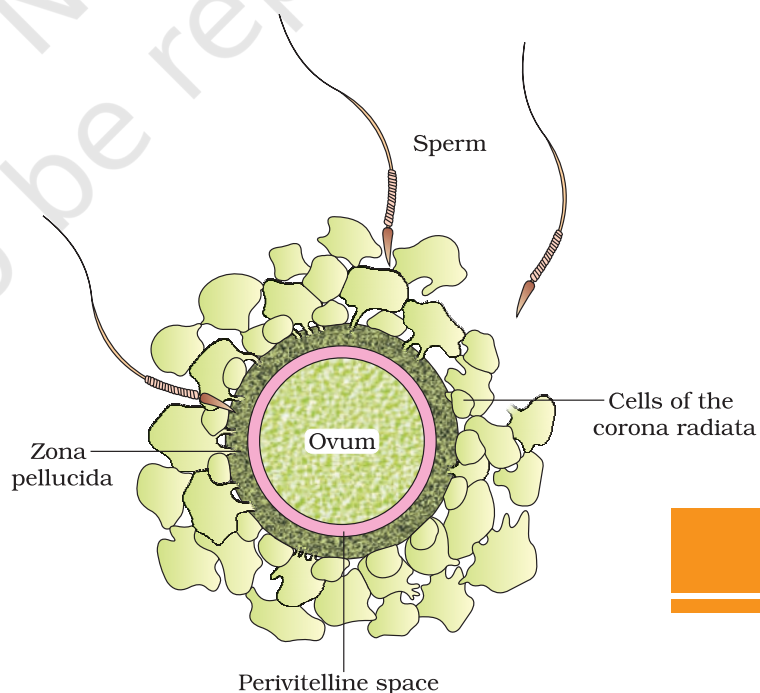
## 2.5 FERTILISATION AND IMPLANTATION

During copulation (coitus) semen is released by the penis into the vagina (insemination). The motile sperms swim rapidly, pass through the cervix, enter into the uterus and finally reach the ampullary region of the fallopian tube (Figure 2.11b). The ovum released by the ovary is also transported to the ampullary region where fertilisation takes place. Fertilisation can only occur if the ovum and sperms are transported simultaneously to the ampullary region. This is the reason why not all copulations lead to fertilisation and pregnancy.

The process of fusion of a sperm with an ovum is called **fertilisation**. During fertilisation, a sperm comes in contact with the *zona pellucida* layer of the ovum (Figure 2.10) and induces changes in the membrane that block the entry of additional sperms. Thus, it ensures that only one sperm can fertilise an ovum. The secretions of the acrosome help the sperm enter into the cytoplasm of the ovum through the *zona pellucida* and the plasma

### Menstrual Hygiene

Maintenance of hygiene and sanitation during menstruation is very important. Take bath and clean yourself regularly. Use sanitary napkins or clean homemade pads. Change sanitary napkins or homemade pads after every 4–5 hrs as per the requirement. Dispose of the used sanitary napkins properly wrapping it with a used paper. Do not throw the used napkins in the drainpipe of toilets or in the open area. After handling the napkin wash hands with soap.

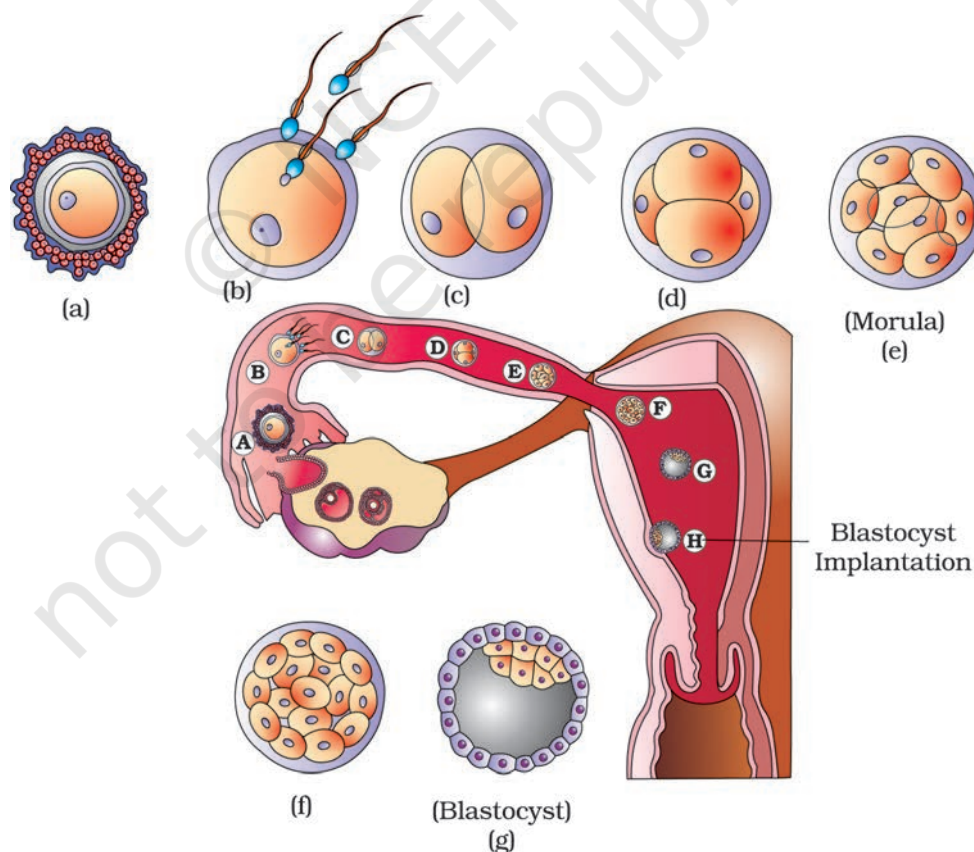


**Figure 2.10** Ovum surrounded by few sperms

membrane. This induces the completion of the meiotic division of the secondary oocyte. The second meiotic division is also unequal and results in the formation of a **second polar body** and a haploid ovum (ootid). Soon the haploid nucleus of the sperms and that of the ovum fuse together to form a diploid **zygote**. *How many chromosomes will be there in the zygote?*

One has to remember that the sex of the baby has been decided at this stage itself. Let us see how? As you know the chromosome pattern in the human female is XX and that in the male is XY. Therefore, all the haploid gametes (ova) produced by the female have the sex chromosome X whereas in the male gametes (sperms) the sex chromosome could be either X or Y, hence, 50 per cent of sperms carry the X chromosome while the other 50 per cent carry the Y. After fusion of the male and female gametes the zygote would carry either XX or XY depending on whether the sperm carrying X or Y fertilised the ovum. The zygote carrying XX would develop into a female baby and XY would form a male (you will learn more about the chromosomal patterns in Chapter 5). *That is why, scientifically it is correct to say that the sex of the baby is determined by the father and not by the mother!*

The mitotic division starts as the zygote moves through the isthmus of the oviduct called **cleavage** towards the uterus (Figure 2.11) and forms 2, 4, 8, 16 daughter cells called **blastomeres**. The embryo with 8 to 16



**Figure 2.11** Transport of ovum, fertilisation and passage of growing embryo through fallopian tube





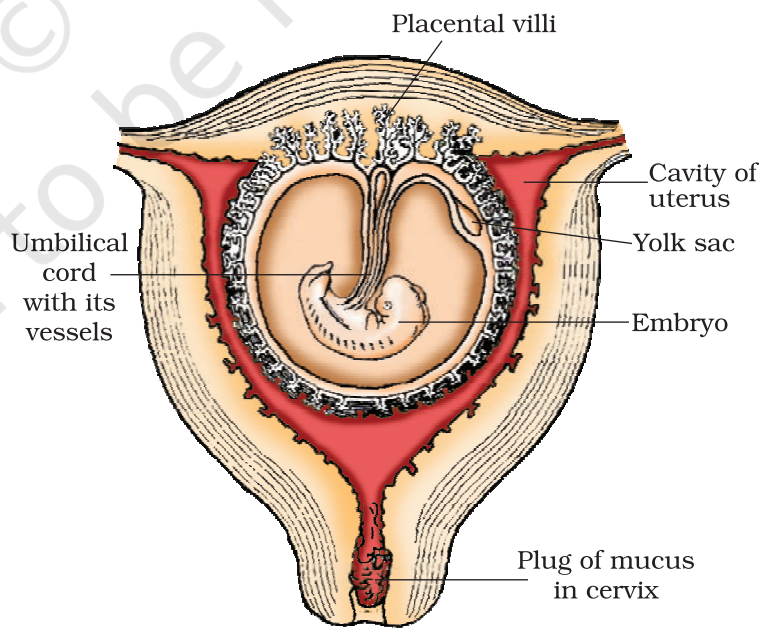
blastomeres is called a morula (Figure 2.11e). The morula continues to divide and transforms into blastocyst (Figure 2.11g) as it moves further into the uterus. The blastomeres in the blastocyst are arranged into an outer layer called **trophoblast** and an inner group of cells attached to trophoblast called the **inner cell mass**. The trophoblast layer then gets attached to the endometrium and the inner cell mass gets differentiated as the embryo. After attachment, the uterine cells divide rapidly and covers the blastocyst. As a result, the blastocyst becomes embedded in the endometrium of the uterus (Figure 2.11 step H). This is called **implantation** and it leads to pregnancy.

## 2.6 PREGNANCY AND EMBRYONIC DEVELOPMENT

After implantation, finger-like projections appear on the trophoblast called **chorionic villi** which are surrounded by the uterine tissue and maternal blood. The chorionic villi and uterine tissue become interdigitated with each other and jointly form a structural and functional unit between developing embryo (foetus) and maternal body called **placenta** (Figure 2.12).

The placenta facilitate the supply of oxygen and nutrients to the embryo and also removal of carbon dioxide and excretory/waste materials produced by the embryo. The placenta is connected to the embryo through an umbilical cord which helps in the transport of substances to and from the embryo. Placenta also acts as an endocrine tissue and produces several hormones like **human chorionic gonadotropin (hCG)**, **human placental lactogen (hPL)**, **estrogens**, **progestogens**, etc. In the later phase of pregnancy, a hormone called **relaxin** is also secreted by the ovary. Let us remember that hCG, hPL and relaxin are produced in women only during pregnancy. In addition, during pregnancy the levels of other hormones like estrogens, progestogens, cortisol, prolactin, thyroxine, etc., are increased several-folds in the maternal blood. Increased production of these hormones is essential for supporting the fetal growth, metabolic changes in the mother and maintenance of pregnancy.

Immediately after implantation, the inner cell mass (embryo) differentiates



**Figure 2.12** The human foetus within the uterus



into an outer layer called **ectoderm** and an inner layer called **endoderm**. A **mesoderm** soon appears between the ectoderm and the endoderm. These three layers give rise to all tissues (organs) in adults. It needs to be mentioned here that the inner cell mass contains certain cells called **stem** cells which have the potency to give rise to all the tissues and organs.

*What are the major features of embryonic development at various months of pregnancy?* The human pregnancy lasts 9 months. *Do you know for how many months pregnancy last in dogs, elephants, cats?* Find out. In human beings, after one month of pregnancy, the embryo's heart is formed. The first sign of growing foetus may be noticed by listening to the heart sound carefully through the stethoscope. By the end of the second month of pregnancy, the foetus develops limbs and digits. By the end of 12 weeks (first trimester), most of the major organ systems are formed, for example, the limbs and external genital organs are well-developed. The first movements of the foetus and appearance of hair on the head are usually observed during the fifth month. By the end of about 24 weeks (end of second trimester), the body is covered with fine hair, eye-lids separate, and eyelashes are formed. By the end of nine months of pregnancy, the foetus is fully developed and is ready for delivery.

## 2.7 PARTURITION AND LACTATION

The average duration of human pregnancy is about 9 months which is called the gestation period. Vigorous contraction of the uterus at the end of pregnancy causes expulsion/delivery of the foetus. This process of delivery of the foetus (childbirth) is called **parturition**. Parturition is induced by a complex neuroendocrine mechanism. The signals for parturition originate from the fully developed foetus and the placenta which induce mild uterine contractions called **foetal ejection reflex**. This triggers release of oxytocin from the maternal pituitary. Oxytocin acts on the uterine muscle and causes stronger uterine contractions, which in turn stimulates further secretion of oxytocin. The stimulatory reflex between the uterine contraction and oxytocin secretion continues resulting in stronger and stronger contractions. This leads to expulsion of the baby out of the uterus through the birth canal – parturition. Soon after the infant is delivered, the placenta is also expelled out of the uterus. *What do you think the doctors inject to induce delivery?*

The mammary glands of the female undergo differentiation during pregnancy and starts producing milk towards the end of pregnancy by the process called **lactation**. This helps the mother in feeding the new-born. The milk produced during the initial few days of lactation is called **colostrum** which contains several antibodies absolutely essential to develop resistance for the new-born babies. Breast-feeding during the initial period of infant growth is recommended by doctors for bringing up a healthy baby.



## SUMMARY

Humans are sexually reproducing and viviparous. The male reproductive system is composed of a pair of testes, the male sex accessory ducts and the accessory glands and external genitalia. Each testis has about 250 compartments called testicular lobules, and each lobule contains one to three highly coiled seminiferous tubules. Each seminiferous tubule is lined inside by spermatogonia and Sertoli cells. The spermatogonia undergo meiotic divisions leading to sperm formation, while Sertoli cells provide nutrition to the dividing germ cells. The Leydig cells outside the seminiferous tubules, synthesise and secrete testicular hormones called androgens. The male external genitalia is called penis.

The female reproductive system consists of a pair of ovaries, a pair of oviducts, a uterus, a vagina, external genitalia, and a pair of mammary glands. The ovaries produce the female gamete (ovum) and some steroid hormones (ovarian hormones). Ovarian follicles in different stages of development are embedded in the stroma. The oviducts, uterus and vagina are female accessory ducts. The uterus has three layers namely perimetrium, myometrium and endometrium. The female external genitalia includes mons pubis, labia majora, labia minora, hymen and clitoris. The mammary glands are one of the female secondary sexual characteristics.

Spermatogenesis results in the formation of sperms that are transported by the male sex accessory ducts. A normal human sperm is composed of a head, neck, a middle piece and tail. The process of formation of mature female gametes is called oogenesis. The reproductive cycle of female primates is called menstrual cycle. Menstrual cycle starts only after attaining sexual maturation (puberty). During ovulation only one ovum is released per menstrual cycle. The cyclical changes in the ovary and the uterus during menstrual cycle are induced by changes in the levels of pituitary and ovarian hormones. After coitus, sperms are transported to the ampulla, where the sperm fertilises the ovum leading to formation of a diploid zygote. The presence of X or Y chromosome in the sperm determines the sex of the embryo. The zygote undergoes repeated mitotic division to form a blastocyst, which is implanted in the uterus resulting in pregnancy. After nine months of pregnancy, the fully developed foetus is ready for delivery. The process of childbirth is called parturition which is induced by a complex neuroendocrine mechanism involving cortisol, estrogens and oxytocin. Mammary glands differentiate during pregnancy and secrete milk after child-birth. The new-born baby is fed milk by the mother (lactation) during the initial few months of growth.



## EXERCISES

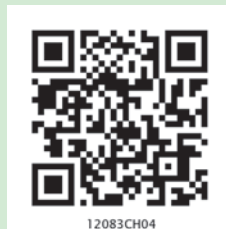
1. Fill in the blanks:
  - (a) Humans reproduce \_\_\_\_\_ (asexually/sexually)
  - (b) Humans are \_\_\_\_\_ (oviparous, viviparous, ovoviviparous)
  - (c) Fertilisation is \_\_\_\_\_ in humans (external/internal)
  - (d) Male and female gametes are \_\_\_\_\_ (diploid/haploid)
  - (e) Zygote is \_\_\_\_\_ (diploid/haploid)



- (f) The process of release of ovum from a mature follicle is called \_\_\_\_\_
- (g) Ovulation is induced by a hormone called \_\_\_\_\_
- (h) The fusion of male and female gametes is called \_\_\_\_\_
- (i) Fertilisation takes place in \_\_\_\_\_
- (j) Zygote divides to form \_\_\_\_\_ which is implanted in uterus.
- (k) The structure which provides vascular connection between foetus and uterus is called \_\_\_\_\_
2. Draw a labelled diagram of male reproductive system.
  3. Draw a labelled diagram of female reproductive system.
  4. Write two major functions each of testis and ovary.
  5. Describe the structure of a seminiferous tubule.
  6. What is spermatogenesis? Briefly describe the process of spermatogenesis.
  7. Name the hormones involved in regulation of spermatogenesis.
  8. Define spermiogenesis and spermiation.
  9. Draw a labelled diagram of sperm.
  10. What are the major components of seminal plasma?
  11. What are the major functions of male accessory ducts and glands?
  12. What is oogenesis? Give a brief account of oogenesis.
  13. Draw a labelled diagram of a section through ovary.
  14. Draw a labelled diagram of a Graafian follicle?
  15. Name the functions of the following:
    - (a) Corpus luteum
    - (b) Endometrium
    - (c) Acrosome
    - (d) Sperm tail
    - (e) Fimbriae
  16. Identify True/False statements. Correct each false statement to make it true.
    - (a) Androgens are produced by Sertoli cells. (True/False)
    - (b) Spermatozoa get nutrition from Sertoli cells. (True/False)
    - (c) Leydig cells are found in ovary. (True/False)
    - (d) Leydig cells synthesise androgens. (True/False)
    - (e) Oogenesis takes place in corpus luteum. (True/False)
    - (f) Menstrual cycle ceases during pregnancy. (True/False)
    - (g) Presence or absence of hymen is not a reliable indicator of virginity or sexual experience. (True/False)
  17. What is menstrual cycle? Which hormones regulate menstrual cycle?
  18. What is parturition? Which hormones are involved in induction of parturition?
  19. In our society the women are often blamed for giving birth to daughters. Can you explain why this is not correct?
  20. How many eggs are released by a human ovary in a month? How many eggs do you think would have been released if the mother gave birth to identical twins? Would your answer change if the twins born were fraternal?
  21. How many eggs do you think were released by the ovary of a female dog which gave birth to 6 puppies?

# CHAPTER 3

# REPRODUCTIVE HEALTH



- 3.1 *Reproductive Health – Problems and Strategies*
- 3.2 *Population Explosion and Birth Control*
- 3.3 *Medical Termination of Pregnancy*
- 3.4 *Sexually Transmitted Diseases*
- 3.5 *Infertility*

You have learnt about human reproductive system and its functions in Chapter 2. Now, let's discuss a closely related topic – reproductive health. *What do we understand by this term?* The term simply refers to healthy reproductive organs with normal functions. However, it has a broader perspective and includes the emotional and social aspects of reproduction also. According to the World Health Organisation (WHO), reproductive health means a total well-being in all aspects of reproduction, i.e., physical, emotional, behavioural and social. Therefore, a society with people having physically and functionally normal reproductive organs and normal emotional and behavioural interactions among them in all sex-related aspects might be called reproductively healthy. Why is it significant to maintain reproductive health and what are the methods taken up to achieve it? Let us examine them.

## 3.1 REPRODUCTIVE HEALTH – PROBLEMS AND STRATEGIES

India was amongst the first countries in the world to initiate action plans and programmes at a national level to attain total reproductive health as a social goal. These programmes called 'family planning' were initiated in 1951 and were periodically assessed over the past decades. Improved programmes covering wider



reproduction-related areas are currently in operation under the popular name 'Reproductive and Child Health Care (RCH) programmes'. Creating awareness among people about various reproduction related aspects and providing facilities and support for building up a reproductively healthy society are the major tasks under these programmes.

With the help of audio-visual and the print-media governmental and non-governmental agencies have taken various steps to create awareness among the people about reproduction-related aspects. Parents, other close relatives, teachers and friends, also have a major role in the dissemination of the above information. Introduction of sex education in schools should also be encouraged to provide right information to the young so as to discourage children from believing in myths and having misconceptions about sex-related aspects. Proper information about reproductive organs, adolescence and related changes, safe and hygienic sexual practices, sexually transmitted diseases (STD), AIDS, etc., would help people, especially those in the adolescent age group to lead a reproductively healthy life. Educating people, especially fertile couples and those in marriageable age group, about available birth control options, care of pregnant mothers, post-natal care of the mother and child, importance of breast feeding, equal opportunities for the male and the female child, etc., would address the importance of bringing up socially conscious healthy families of desired size. Awareness of problems due to uncontrolled population growth, social evils like sex-abuse and sex-related crimes, etc., need to be created to enable people to think and take up necessary steps to prevent them and thereby build up a socially responsible and healthy society.

Successful implementation of various action plans to attain reproductive health requires strong infrastructural facilities, professional expertise and material support. These are essential to provide medical assistance and care to people in reproduction-related problems like pregnancy, delivery, STDs, abortions, contraception, menstrual problems, infertility, etc. Implementation of better techniques and new strategies from time to time are also required to provide more efficient care and assistance to people. Statutory ban on **amniocentesis** for sex-determination to legally check increasing menace of female foeticides, massive child immunisation, etc., are some programmes that merit mention in this connection. In amniocentesis some of the amniotic fluid of the developing foetus is taken to analyse the fetal cells and dissolved substances. This procedure is used to test for the presence of certain genetic disorders such as, down syndrome, haemophilia, sickle-cell anemia, etc., determine the survivability of the foetus.

Research on various reproduction-related areas are encouraged and supported by governmental and non-governmental agencies to find out new methods and/or to improve upon the existing ones. *Do you know that 'Saheli'—a new oral contraceptive for the females—was developed*



by scientists at Central Drug Research Institute (CDRI) in Lucknow, India? Better awareness about sex related matters, increased number of medically assisted deliveries and better post-natal care leading to decreased maternal and infant mortality rates, increased number of couples with small families, better detection and cure of STDs and overall increased medical facilities for all sex-related problems, etc. all indicate improved reproductive health of the society.

### 3.2 POPULATION STABILISATION AND BIRTH CONTROL

In the last century an all-round development in various fields significantly improved the quality of life of the people. However, increased health facilities along with better living conditions had an explosive impact on the growth of population. The world population which was around 2 billion (2000 million) in 1900 rocketed to about 6 billion by 2000 and 7.2 billion in 2011. A similar trend was observed in India too. Our population which was approximately 350 million at the time of our independence reached close to the billion mark by 2000 and crossed 1.2 billion in May 2011. A rapid decline in death rate, **maternal mortality rate** (MMR) and **infant mortality rate** (IMR) as well as an increase in number of people in reproductive age are probable reasons for this. Through our Reproductive Child Health (RCH) programme, though we could bring down the population growth rate, it was only marginal. According to the 2011 census report, the population growth rate was less than 2 per cent, i.e., 20/1000/year, a rate at which our population could increase rapidly. Such an alarming growth rate could lead to an absolute scarcity of even the basic requirements, i.e., food, shelter and clothing, in spite of significant progress made in those areas. Therefore, the government was forced to take up serious measures to check this population growth rate.

The most important step to overcome this problem is to motivate smaller families by using various contraceptive methods. You might have seen advertisements in the media as well as posters/bills, etc., showing a happy couple with two children with a slogan *Hum Do Hamare Do* (we two, our two). Many couples, mostly the young, urban, working ones have even adopted an 'one child norm'. Statutory raising of marriageable age of the female to 18 years and that of males to 21 years, and incentives given to couples with small families are two of the other measures taken to tackle this problem. Let us describe some of the commonly used contraceptive methods, which help prevent unwanted pregnancies.

An ideal contraceptive should be user-friendly, easily available, effective and reversible with no or least side-effects. It also should in no way interfere with the sexual drive, desire and/or the sexual act of the user. A wide range of contraceptive methods are presently available which could be broadly grouped into the following categories, namely Natural/Traditional, Barrier, IUDs, Oral contraceptives, Injectables, Implants and Surgical methods.



**Natural methods** work on the principle of avoiding chances of ovum and sperms meeting. **Periodic abstinence** is one such method in which the couples avoid or abstain from coitus from day 10 to 17 of the menstrual cycle when ovulation could be expected. As chances of fertilisation are very high during this period, it is called the fertile period. Therefore, by abstaining from coitus during this period, conception could be prevented. **Withdrawal or coitus interruptus** is another method in which the male partner withdraws his penis from the vagina just before ejaculation so as to avoid insemination. **Lactational amenorrhoea** (absence of menstruation) method is based on the fact that ovulation and therefore the cycle do not occur during the period of intense lactation following parturition. Therefore, as long as the mother breast-feeds the child fully, chances of conception are almost nil. However, this method has been reported to be effective only upto a maximum period of six months following parturition. As no medicines or devices are used in these methods, side effects are almost nil. Chances of failure, though, of this method are also high.



Figure 3.1(a) Condom for male

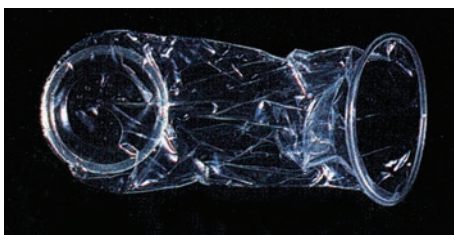


Figure 3.1(b) Condom for female

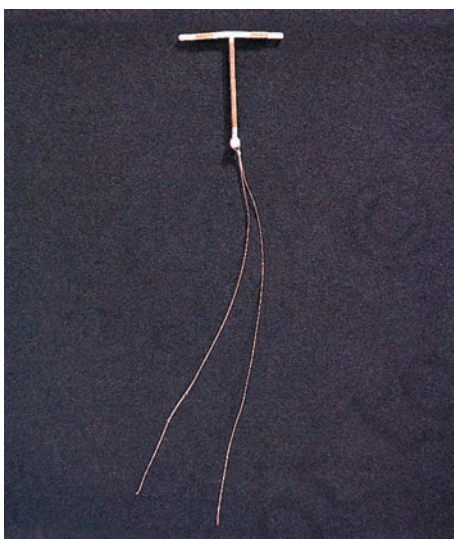


Figure 3.2. Copper T (CuT)

In **barrier** methods, ovum and sperms are prevented from physically meeting with the help of barriers. Such methods are available for both males and females. **Condoms** (Figure 3.1 a, b) are barriers made of thin rubber/latex sheath that are used to cover the penis in the male or vagina and cervix in the female, just before coitus so that the ejaculated semen would not enter into the female reproductive tract. This can prevent conception. 'Nirodh' is a popular brand of condom for the male. Use of condoms has increased in recent years due to its additional benefit of protecting the user from contracting STIs and AIDS. Both the male and the female condoms are disposable, can be self-inserted and thereby gives privacy to the user. **Diaphragms, cervical caps and vaults** are also barriers made of rubber that are inserted into the female reproductive tract to cover the cervix during coitus. They prevent conception by blocking the entry of sperms through the cervix. They are reusable. Spermicidal creams, jellies and foams are usually used alongwith these barriers to increase their contraceptive efficiency.

Another effective and popular method is the use of **Intra Uterine Devices (IUDs)**. These devices are inserted by doctors or expert nurses in the uterus through vagina. These Intra Uterine Devices are presently available as the non-medicated IUDs (e.g., Lippes loop), copper releasing IUDs (CuT, Cu7, Multiload 375) and the hormone releasing IUDs (Progestasert, LNG-20) (Figure 3.2). IUDs increase phagocytosis of sperms within the uterus and the Cu ions released suppress sperm motility and the fertilising capacity of sperms. The hormone releasing IUDs, in addition,



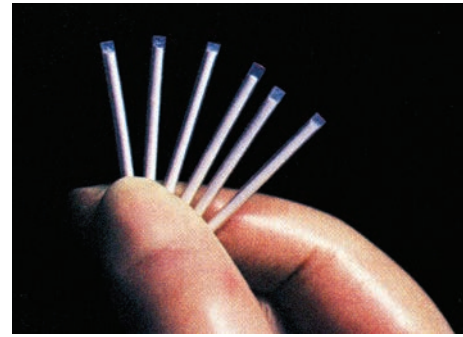


make the uterus unsuitable for implantation and the cervix hostile to the sperms. IUDs are ideal contraceptives for the females who want to delay pregnancy and/or space children. It is one of most widely accepted methods of contraception in India.

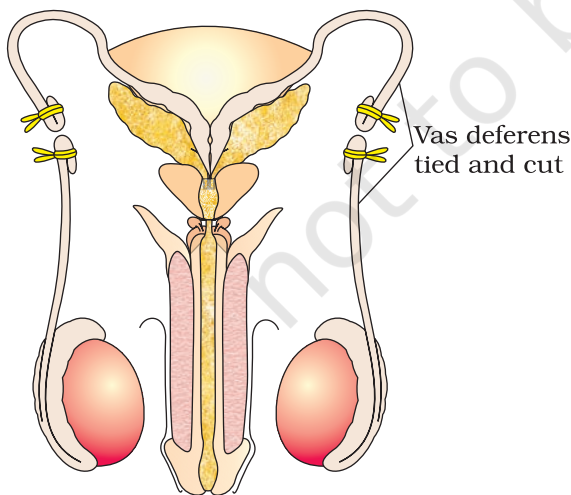
Oral administration of small doses of either progestogens or progestogen-estrogen combinations is another contraceptive method used by the females. They are used in the form of tablets and hence are popularly called the **pills**. Pills have to be taken daily for a period of 21 days starting preferably within the first five days of menstrual cycle. After a gap of 7 days (during which menstruation occurs) it has to be repeated in the same pattern till the female desires to prevent conception. They inhibit ovulation and implantation as well as alter the quality of cervical mucus to prevent/retard entry of sperms. Pills are very effective with lesser side effects and are well accepted by the females. *Saheli*—the new oral contraceptive for the females contains a non-steroidal preparation. It is a 'once a week' pill with very few side effects and high contraceptive value.

Progestogens alone or in combination with estrogen can also be used by females as injections or implants under the skin (Figure 3.3). Their mode of action is similar to that of pills and their effective periods are much longer. Administration of progestogens or progestogen-estrogen combinations or IUDs within 72 hours of coitus have been found to be very effective as emergency contraceptives as they could be used to avoid possible pregnancy due to rape or casual unprotected intercourse.

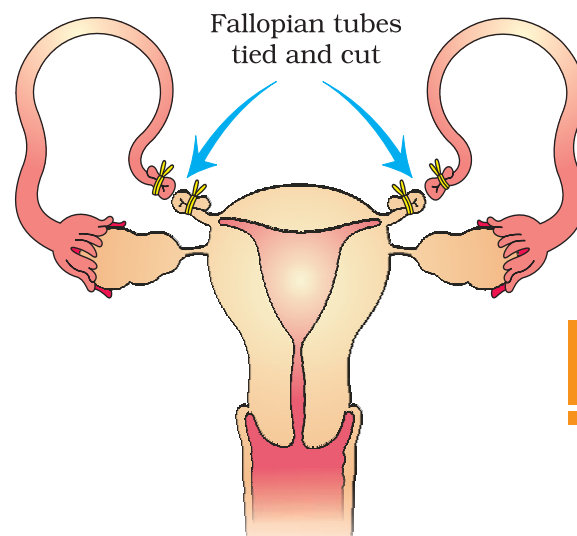
Surgical methods, also called **sterilisation**, are generally advised for the male/female partner as a terminal method to prevent any more



**Figure 3.3** Implants



**Figure 3.4 (a)** Vasectomy



**Figure 3.4 (b)** Tubectomy

The Medical Termination of Pregnancy (Amendment) Act, 2017 was enacted by the government of India with the intention of reducing the incidence of illegal abortion and consequent maternal mortality and morbidity. According to this Act, a pregnancy may be terminated on certain considered grounds within the first 12 weeks of pregnancy on the opinion of one registered medical practitioner. If the pregnancy has lasted more than 12 weeks, but fewer than 24 weeks, two registered medical practitioners must be of the opinion, formed in good faith, that the required ground exist. The grounds for such termination of pregnancies are:

- (i) The continuation of the pregnancy would involve a risk to the life of the pregnant woman or of grave injury physical or mental health; or
- (ii) There is a substantial risk that of the child were born, it would suffer from such physical or mental abnormalities as to be seriously handicapped.

pregnancies. Surgical intervention blocks gamete transport and thereby prevent conception. Sterilisation procedure in the male is called 'vasectomy' and that in the female, 'tubectomy'. In vasectomy, a small part of the vas deferens is removed or tied up through a small incision on the scrotum (Figure 3.4a) whereas in tubectomy, a small part of the fallopian tube is removed (Figure 3.4b) or tied up through a small incision in the abdomen or through vagina. These techniques are highly effective but their reversibility is very poor.

It needs to be emphasised that the selection of a suitable contraceptive method and its use should always be undertaken in consultation with qualified medical professionals. One must also remember that contraceptives are not regular requirements for the maintenance of reproductive health. In fact, they are practiced against a natural reproductive event, i.e., conception/pregnancy. One is forced to use these methods either to prevent pregnancy or to delay or space pregnancy due to personal reasons. No doubt, the widespread use of these methods have a significant role in checking uncontrolled growth of population. However, their possible ill-effects like nausea, abdominal pain, breakthrough bleeding, irregular menstrual bleeding or even breast cancer, though not very significant, should not be totally ignored.

### 3.3 MEDICAL TERMINATION OF PREGNANCY (MTP)

Intentional or voluntary termination of pregnancy before full term is called **medical termination of pregnancy (MTP)** or induced abortion. Nearly 45 to 50 million MTPs are performed in a year all over the world which accounts to 1/5th of the total number of conceived pregnancies in a year. Whether to accept / legalise MTP or not is being debated upon in many countries due to emotional, ethical, religious and social issues involved in it. Government of India legalised MTP in 1971 with some strict conditions to avoid its misuse. Such restrictions are all the more important to check indiscriminate and illegal female foeticides which are reported to be high in India.

Why MTP? Obviously the answer is—to get rid of unwanted pregnancies either due to casual unprotected intercourse or failure of the contraceptive used during coitus or rapes. MTPs are also essential in certain cases where continuation of the pregnancy could be harmful or even fatal either to the mother or to the foetus or both.

MTPs are considered relatively safe during the first trimester, i.e., upto 12 weeks of pregnancy. Second trimester abortions are much more riskier. One disturbing trend observed is that a majority of the MTPs are performed illegally by unqualified quacks which are not only unsafe but could be fatal too. Another dangerous trend is the misuse of amniocentesis to determine the sex of the unborn child. Frequently, if the foetus is found to be female, it is followed by MTP- this is totally against what is legal.



Such practices should be avoided because these are dangerous both for the young mother and the foetus. Effective counselling on the need to avoid unprotected coitus and the risk factors involved in illegal abortions as well as providing more health care facilities could reverse the mentioned unhealthy trend.

### 3.4 SEXUALLY TRANSMITTED INFECTIONS (STIs)

Infections or diseases which are transmitted through sexual intercourse are collectively called sexually transmitted infections (STI) or venereal diseases (VD) or reproductive tract infections (RTI). Gonorrhoea, syphilis, genital herpes, chlamydia, genital warts, trichomoniasis, hepatitis-B and of course, the most discussed infection in the recent years, HIV leading to AIDS are some of the common STIs. Among these, HIV infection is most dangerous and is discussed in detail in Chapter 7.

Some of these infections like hepatitis-B and HIV can also be transmitted by sharing of injection needles, surgical instruments, etc., with infected persons, transfusion of blood, or from an infected mother to the foetus too. Except for hepatitis-B, genital herpes and HIV infections, other diseases are completely curable if detected early and treated properly. Early symptoms of most of these are minor and include itching, fluid discharge, slight pain, swellings, etc., in the genital region. Infected females may often be asymptomatic and hence, may remain undetected for long. Absence or less significant symptoms in the early stages of infection and the social stigma attached to the STIs, deter the infected persons from going for timely detection and proper treatment. This could lead to complications later, which include pelvic inflammatory diseases (PID), abortions, still births, ectopic pregnancies, infertility or even cancer of the reproductive tract. STIs are a major threat to a healthy society. Therefore, prevention or early detection and cure of these diseases are given prime consideration under the reproductive health-care programmes. Though all persons are vulnerable to these infections, their incidences are reported to be very high among persons in the age group of 15-24 years – the age group to which you also belong. There is no reason to panic because prevention is possible. One could be free of these infections by following the simple principles given below:

- (i) Avoid sex with unknown partners/multiple partners.
- (ii) Always try to use condoms during coitus.
- (iii) In case of doubt, one should go to a qualified doctor for early detection and get complete treatment if diagnosed with infection.

### 3.5 INFERTILITY

A discussion on reproductive health is incomplete without a mention of infertility. A large number of couples all over the world including India are infertile, i.e., they are unable to produce children inspite of unprotected



sexual co-habitation. The reasons for this could be many—physical, congenital, diseases, drugs, immunological or even psychological. In India, often the female is blamed for the couple being childless, but more often than not, the problem lies in the male partner. Specialised health care units (infertility clinics, etc.) could help in diagnosis and corrective treatment of some of these disorders and enable these couples to have children. However, where such corrections are not possible, the couples could be assisted to have children through certain special techniques commonly known as **assisted reproductive technologies** (ART).

**In vitro fertilisation** (IVF—fertilisation outside the body in almost similar conditions as that in the body) followed by **embryo transfer** (ET) is one of such methods. In this method, popularly known as **test tube baby** programme, ova from the wife/donor (female) and sperms from the husband/donor (male) are collected and are induced to form zygote under simulated conditions in the laboratory. The zygote or early embryos (with upto 8 blastomeres) could then be transferred into the fallopian tube (**ZIFT—zygote intra fallopian transfer**) and embryos with more than 8 blastomeres, into the uterus (**IUT – intra uterine transfer**), to complete its further development. Embryos formed by **in-vivo fertilisation** (fusion of gametes within the female) also could be used for such transfer to assist those females who cannot conceive.

Transfer of an ovum collected from a donor into the fallopian tube (**GIFT – gamete intra fallopian transfer**) of another female who cannot produce one, but can provide suitable environment for fertilisation and further development is another method attempted. **Intra cytoplasmic sperm injection** (ICSI) is another specialised procedure to form an embryo in the laboratory in which a sperm is directly injected into the ovum. Infertility cases either due to inability of the male partner to inseminate the female or due to very low sperm counts in the ejaculates, could be corrected by **artificial insemination** (AI) technique. In this technique, the semen collected either from the husband or a healthy donor is artificially introduced either into the vagina or into the uterus (**IUI – intra-uterine insemination**) of the female.

Though options are many, all these techniques require extremely high precision handling by specialised professionals and expensive instrumentation. Therefore, these facilities are presently available only in very few centres in the country. Obviously their benefits is affordable to only a limited number of people. Emotional, religious and social factors are also deterrents in the adoption of these methods. Since the ultimate aim of all these procedures is to have children, in India we have so many orphaned and destitute children, who would probably not survive till maturity, unless taken care of. Our laws permit legal adoption and it is as yet, one of the best methods for couples looking for parenthood.



## SUMMARY

Reproductive health refers to a total well-being in all aspects of reproduction, i.e., physical, emotional, behavioural and social. Our nation was the first nation in the world to initiate various action plans at national level towards attaining a reproductively healthy society.

Counselling and creating awareness among people about reproductive organs, adolescence and associated changes, safe and hygienic sexual practices, sexually transmitted infections (STIs) including AIDS, etc., is the primary step towards reproductive health. Providing medical facilities and care to the problems like menstrual irregularities, pregnancy related aspects, delivery, medical termination of pregnancy, STIs, birth control, infertility, post natal child and maternal management is another important aspect of the Reproductive and Child Health Care programmes.

An overall improvement in reproductive health has taken place in our country as indicated by reduced maternal and infant mortality rates, early detection and cure of STIs, assistance to infertile couples, etc. Improved health facilities and better living conditions promoted an explosive growth of population. Such a growth necessitated intense propagation of contraceptive methods. Various contraceptive options are available now such as natural, traditional, barrier, IUDs, pills, injectables, implants and surgical methods. Though contraceptives are not regular requirements for reproductive health, one is forced to use them to avoid pregnancy or to delay or space pregnancy.

Medical termination of pregnancy is legalised in our country. MTP is generally performed to get rid of unwanted pregnancy due to rapes, casual relationship, etc., as also in cases when the continuation of pregnancy could be harmful or even fatal to either the mother, or the foetus or both.

Infections or diseases transmitted through sexual intercourse are called Sexually Transmitted Diseases (STIs). Pelvic Inflammatory Diseases (PIDs), still birth, infertility are some of the complications of them. Early detection facilitate better cure of these diseases. Avoiding sexual intercourse with unknown/multiple partners, use of condoms during coitus are some of the simple precautions to avoid contracting STIs.

Inability to conceive or produce children even after 2 years of unprotected sexual cohabitation is called infertility. Various methods are now available to help such couples. *In Vitro* fertilisation followed by transfer of embryo into the female genital tract is one such method and is commonly known as the 'Test Tube Baby' Programme.



# EXERCISES

1. What do you think is the significance of reproductive health in a society?
  2. Suggest the aspects of reproductive health which need to be given special attention in the present scenario.
  3. Is sex education necessary in schools? Why?
  4. Do you think that reproductive health in our country has improved in the past 50 years? If yes, mention some such areas of improvement.
  5. What are the suggested reasons for population explosion?
  6. Is the use of contraceptives justified? Give reasons.
  7. Removal of gonads cannot be considered as a contraceptive option. Why?
  8. Amniocentesis for sex determination is banned in our country. Is this ban necessary? Comment.
  9. Suggest some methods to assist infertile couples to have children.
  10. What are the measures one has to take to prevent from contracting STDs?
  11. State True/False with explanation
    - (a) Abortions could happen spontaneously too. (True/False)
    - (b) Infertility is defined as the inability to produce a viable offspring and is always due to abnormalities/defects in the female partner. (True/False)
    - (c) Complete lactation could help as a natural method of contraception. (True/False)
    - (d) Creating awareness about sex related aspects is an effective method to improve reproductive health of the people. (True/False)
  12. Correct the following statements :
    - (a) Surgical methods of contraception prevent gamete formation.
    - (b) All sexually transmitted diseases are completely curable.
    - (c) Oral pills are very popular contraceptives among the rural women.
    - (d) In E. T. techniques, embryos are always transferred into the uterus.
- 
-

# UNIT VII

# GENETICS AND EVOLUTION

## **Chapter 4**

Principles of Inheritance  
and Variation

## **Chapter 5**

Molecular Basis of Inheritance

## **Chapter 6**

Evolution

The work of Mendel and others who followed him gave us an idea of inheritance patterns. However the nature of those 'factors' which determine the phenotype was not very clear. As these 'factors' represent the genetic basis of inheritance, understanding the structure of genetic material and the structural basis of genotype and phenotype conversion became the focus of attention in biology for the next century. The entire body of molecular biology was a consequent development with major contributions from Watson, Crick, Nirenberg, Khorana, Kornbergs (father and son), Benzer, Monod, Brenner, etc. A parallel problem being tackled was the mechanism of evolution. Awareness in the areas of molecular genetics, structural biology and bio informatics have enriched our understanding of the molecular basis of evolution. In this unit the structure and function of DNA and the story and theory of evolution have been examined and explained.



James Dewey Watson was born in Chicago on 6 April 1928. In 1947, he received B.Sc. degree in Zoology. During these years his interest in bird-watching had matured into a serious desire to learn genetics. This became possible when he received a Fellowship for graduate study in Zoology at Indiana University, Bloomington, where he received his Ph.D. degree in 1950 on a study of the effect of hard X-rays on bacteriophage multiplication.



JAMES WATSON  
FRANCIS CRICK

He met Crick and discovered their common interest in solving the DNA structure. Their first serious effort, was unsatisfactory. Their second effort based upon more experimental evidence and better appreciation of the nucleic acid literature, resulted, early in March 1953, in the proposal of the complementary double-helical configuration.

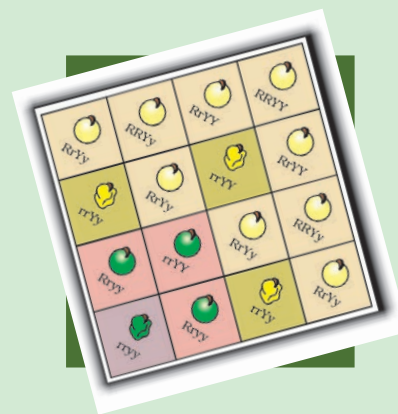
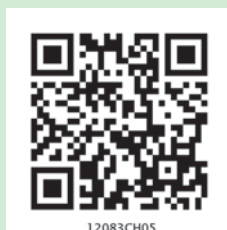
Francis Harry Compton Crick was born on 8 June 1916, at Northampton, England. He studied physics at University College, London and obtained a B.Sc. in 1937. He completed Ph.D. in 1954 on a thesis entitled "X-ray Diffraction: Polypeptides and Proteins".

A critical influence in Crick's career was his friendship with J. D. Watson, then a young man of 23, leading in 1953 to the proposal of the double-helical structure for DNA and the replication scheme. Crick was made an F.R.S. in 1959.

The honours to Watson with Crick include: the John Collins Warren Prize of the Massachusetts General Hospital, in 1959; the Lasker Award, in 1960; the Research Corporation Prize, in 1962 and above all, the Nobel Prize in 1962.



# CHAPTER 4



## PRINCIPLES OF INHERITANCE AND VARIATION















- 4.1 *Mendel's Laws of Inheritance*
- 4.2 *Inheritance of One Gene*
- 4.3 *Inheritance of Two Genes*
- 4.4 *Sex Determination*
- 4.5 *Mutation*
- 4.6 *Genetic Disorders*

Have you ever wondered why an elephant always gives birth only to a baby elephant and not some other animal? Or why a mango seed forms only a mango plant and not any other plant?

Given that they do, are the offspring identical to their parents? Or do they show differences in some of their characteristics? Have you ever wondered why siblings sometimes look so similar to each other? Or sometimes even so different?

These and several related questions are dealt with, scientifically, in a branch of biology known as Genetics. This subject deals with the inheritance, as well as the variation of characters from parents to offspring. Inheritance is the process by which characters are passed on from parent to progeny; it is the basis of heredity. Variation is the degree by which progeny differ from their parents.

Humans knew from as early as 8000-1000 B.C. that one of the causes of variation was hidden in sexual reproduction. They exploited the variations that were naturally present in the wild populations of plants and animals to selectively breed and select for organisms that possessed desirable characters. For example, through artificial selection and domestication from ancestral

Character	Dominant trait	Recessive trait
Seed shape	 Round	 Wrinkled
Seed colour	 Yellow	 Green
Flower colour	 Violet	 White
Pod shape	 Full	 Constricted
Pod colour	 Green	 Yellow
Flower position	 Axial	 Terminal
Stem height	 Tall	 Dwarf

**Figure 4.1** Seven pairs of contrasting traits in pea plant studied by Mendel

wild cows, we have well-known Indian breeds, e.g., Sahiwal cows in Punjab. We must, however, recognise that though our ancestors knew about the inheritance of characters and variation, they had very little idea about the scientific basis of these phenomena.

#### 4.1 MENDEL'S LAWS OF INHERITANCE

It was during the mid-nineteenth century that headway was made in the understanding of inheritance. Gregor Mendel, conducted hybridisation experiments on garden peas for seven years (1856-1863) and proposed the laws of inheritance in living organisms. During Mendel's investigations into inheritance patterns it was for the first time that statistical analysis and mathematical logic were applied to problems in biology. His experiments had a large sampling size, which gave greater credibility to the data that he collected. Also, the confirmation of his inferences from experiments on successive generations of his test plants, proved that his results pointed to general rules of inheritance rather than being unsubstantiated ideas. Mendel investigated characters in the garden pea plant that were manifested as two opposing traits, e.g., tall or dwarf plants, yellow or green seeds. This allowed him to set up a basic framework of rules governing inheritance, which was expanded on by later scientists to account for all the diverse natural observations and the complexity inherent in them.

Mendel conducted such artificial pollination/cross pollination experiments using several true-breeding pea lines. A true-breeding line is one that, having undergone

continuous self-pollination, shows the stable trait inheritance and expression for several generations. Mendel selected 14 true-breeding pea plant varieties, as pairs which were similar except for one character with contrasting traits. Some of the contrasting traits selected were smooth or wrinkled seeds, yellow or green seeds, inflated (full) or constricted green or yellow pods and tall or dwarf plants (Figure 4.1, Table 4.1).



**Table 4.1: Contrasting Traits Studied by Mendel in Pea**

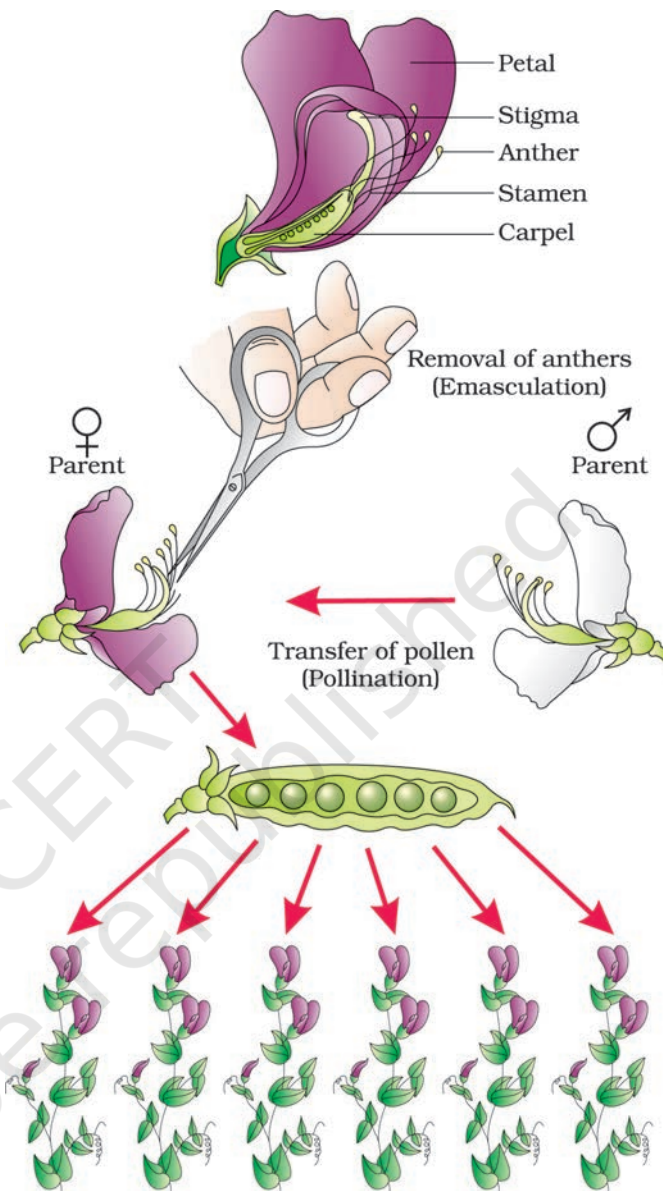
S.No.	Characters	Contrasting Traits
1.	Stem height	Tall/dwarf
2.	Flower colour	Violet/white
3.	Flower position	Axial/terminal
4.	Pod shape	Inflated/constricted
5.	Pod colour	Green/yellow
6.	Seed shape	Round/wrinkled
7.	Seed colour	Yellow/green

### 4.2 INHERITANCE OF ONE GENE

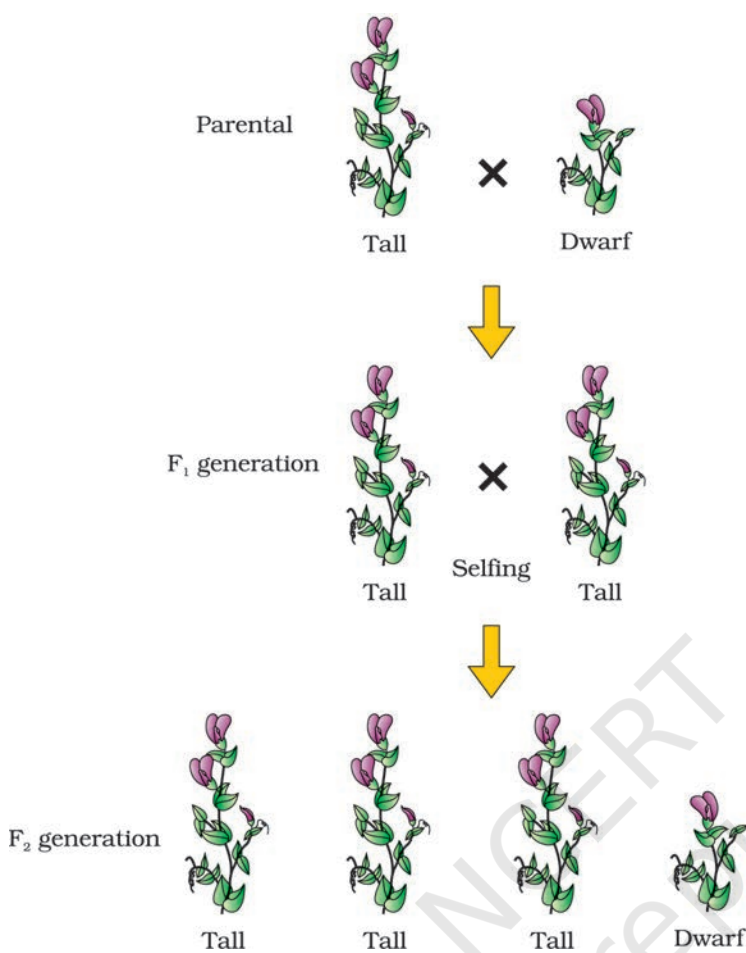
Let us take the example of one such hybridisation experiment carried out by Mendel where he crossed tall and dwarf pea plants to study the inheritance of one gene (Figure 4.2). He collected the seeds produced as a result of this cross and grew them to generate plants of the first hybrid generation. This generation is also called the **Filial<sub>1</sub> progeny** or the **F<sub>1</sub>**. Mendel observed that all the F<sub>1</sub> progeny plants were tall, like one of its parents; none were dwarf (Figure 4.3). He made similar observations for the other pairs of traits – he found that the F<sub>1</sub> always resembled either one of the parents, and that the trait of the other parent was not seen in them.

Mendel then self-pollinated the tall F<sub>1</sub> plants and to his surprise found that in the Filial<sub>2</sub> generation some of the offspring were ‘dwarf’; the character that was not seen in the F<sub>1</sub> generation was now expressed. The proportion of plants that were dwarf were 1/4<sup>th</sup> of the F<sub>2</sub> plants while 3/4<sup>th</sup> of the F<sub>2</sub> plants were tall. The tall and dwarf traits were identical to their parental type and did not show any blending, that is all the offspring were either tall or dwarf, none were of in-between height (Figure 4.3).

Similar results were obtained with the other traits that he studied: only one of the parental traits was expressed in the F<sub>1</sub> generation while at the F<sub>2</sub> stage both the traits were expressed in the proportion 3:1. The contrasting traits did not show any blending at either F<sub>1</sub> or F<sub>2</sub> stage.



**Figure 4.2** Steps in making a cross in pea



**Figure 4.3** Diagrammatic representation of monohybrid cross

Based on these observations, Mendel proposed that something was being stably passed down, unchanged, from parent to offspring through the gametes, over successive generations. He called these things as 'factors'. Now we call them as **genes**. Genes, therefore, are the units of inheritance. They contain the information that is required to express a particular trait in an organism. Genes which code for a pair of contrasting traits are known as **alleles**, i.e., they are slightly different forms of the same gene.

If we use alphabetical symbols for each gene, then the capital letter is used for the trait expressed at the F<sub>1</sub> stage and the small alphabet for the other trait. For example, in case of the character of height, **T** is used for the Tall trait and **t** for the 'dwarf', and **T** and **t** are alleles of each other. Hence, in plants the pair of alleles for height would be **TT**, **Tt** or **tt**. Mendel also proposed that in a true breeding, tall or dwarf pea variety the allelic pair of genes for height are

identical or **homozygous**, **TT** and **tt**, respectively. **TT** and **tt** are called the **genotype** of the plant while the descriptive terms **tall** and **dwarf** are the **phenotype**. What then would be the phenotype of a plant that had a genotype **Tt**?

As Mendel found the phenotype of the F<sub>1</sub> heterozygote **Tt** to be exactly like the **TT** parent in appearance, he proposed that in a pair of dissimilar factors, one dominates the other (as in the F<sub>1</sub>) and hence is called the **dominant** factor while the other factor is **recessive**. In this case **T** (for tallness) is dominant over **t** (for dwarfness), that is recessive. He observed identical behaviour for all the other characters/trait-pairs that he studied.

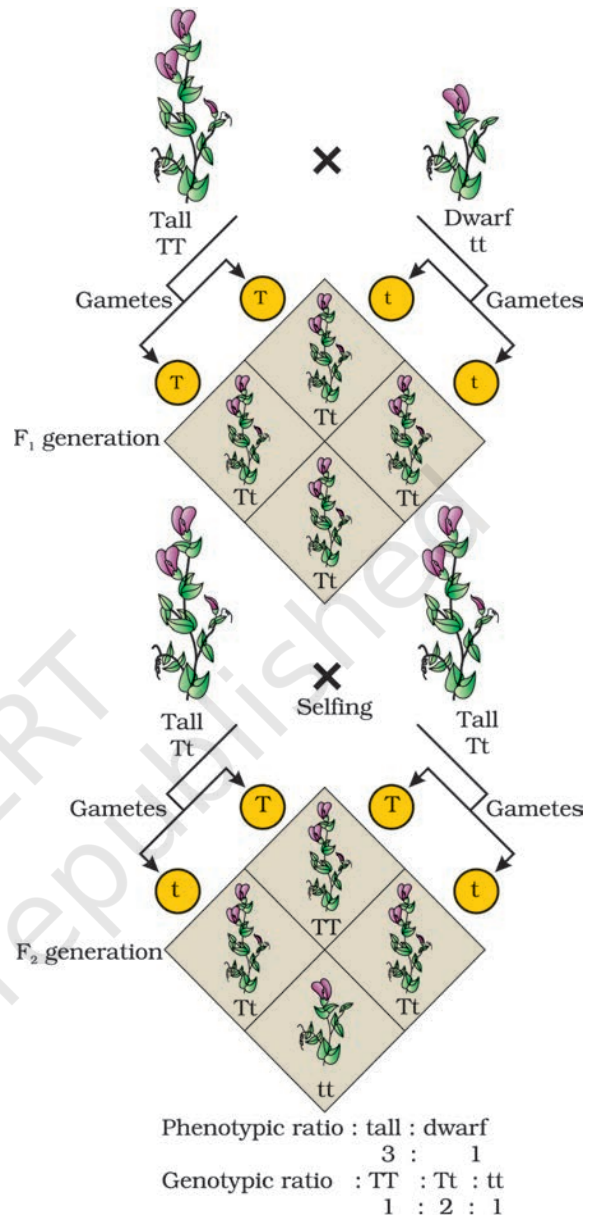
It is convenient (and logical) to use the capital and lower case of an alphabetical symbol to remember this concept of dominance and recessiveness. (Do not use **T** for tall and **d** for dwarf because you will find it difficult to remember whether **T** and **d** are alleles of the same gene/character or not). Alleles can be similar as in the case of homozygotes **TT** and **tt** or can be dissimilar as in the case of the heterozygote **Tt**. Since



the **Tt** plant is heterozygous for genes controlling one character (height), it is a **monohybrid** and the cross between **TT** and **tt** is a **monohybrid cross**.

From the observation that the recessive parental trait is expressed without any blending in the  $F_2$  generation, we can infer that, when the tall and dwarf plant produce gametes, by the process of meiosis, the alleles of the parental pair separate or **segregate** from each other and only one allele is transmitted to a gamete. This segregation of alleles is a random process and so there is a 50 per cent chance of a gamete containing either allele, as has been verified by the results of the crossings. In this way the gametes of the tall **TT** plants have the allele **T** and the gametes of the dwarf **tt** plants have the allele **t**. During fertilisation the two alleles, **T** from one parent say, through the pollen, and **t** from the other parent, then through the egg, are united to produce zygotes that have one **T** allele and one **t** allele. In other words the hybrids have **Tt**. Since these hybrids contain alleles which express contrasting traits, the plants are **heterozygous**. The production of gametes by the parents, the formation of the zygotes, the  $F_1$  and  $F_2$  plants can be understood from a diagram called **Punnett Square** as shown in Figure 4.4. It was developed by a British geneticist, Reginald C. Punnett. It is a graphical representation to calculate the probability of all possible genotypes of offspring in a genetic cross. The possible gametes are written on two sides, usually the top row and left columns. All possible combinations are represented in boxes below in the squares, which generates a square output form.

The Punnett Square shows the parental tall **TT** (male) and dwarf **tt** (female) plants, the gametes produced by them and, the  $F_1$  **Tt** progeny. The  $F_1$  plants of genotype **Tt** are self-pollinated. The symbols ♀ and ♂ are used to denote the female (eggs) and male (pollen) of the  $F_1$  generation, respectively. The  $F_1$  plant of the genotype **Tt** when self-pollinated, produces gametes of the genotype **T** and **t** in equal proportion. When fertilisation takes place, the pollen grains of genotype **T** have a 50 per cent chance to pollinate eggs of the genotype **T**, as well as of genotype **t**. Also pollen grains of genotype **t** have a 50 per cent chance



**Figure 4.4** A Punnett square used to understand a typical monohybrid cross conducted by Mendel between true-breeding tall plants and true-breeding dwarf plants



of pollinating eggs of genotype **T**, as well as of genotype **t**. As a result of random fertilisation, the resultant zygotes can be of the genotypes **TT**, **Tt** or **tt**.

From the Punnett square it is easily seen that  $1/4^{\text{th}}$  of the random fertilisations lead to **TT**,  $1/2$  lead to **Tt** and  $1/4^{\text{th}}$  to **tt**. Though the  $F_1$  have a genotype of **Tt**, but the phenotypic character seen is 'tall'. At  $F_2$ ,  $3/4^{\text{th}}$  of the plants are tall, where some of them are **TT** while others are **Tt**. Externally it is not possible to distinguish between the plants with the genotypes **TT** and **Tt**. Hence, within the genotypic pair **Tt** only one character '**T**' tall is expressed. Hence the character **T** or 'tall' is said to dominate over the other allele **t** or 'dwarf' character. It is thus due to this dominance of one character over the other that all the  $F_1$  are tall (though the genotype is **Tt**) and in the  $F_2$   $3/4^{\text{th}}$  of the plants are tall (though genotypically  $1/2$  are **Tt** and only  $1/4^{\text{th}}$  are **TT**). This leads to a phenotypic ratio of  $3/4^{\text{th}}$  tall : ( $1/4$  **TT** +  $1/2$  **Tt**) and  $1/4^{\text{th}}$  **tt**, i.e., a 3:1 ratio, but a genotypic ratio of 1:2:1.

The  $1/4 : 1/2 : 1/4$  ratio of **TT**: **Tt**: **tt** is mathematically condensable to the form of the binomial expression  $(ax + by)^2$ , that has the gametes bearing genes **T** or **t** in equal frequency of  $1/2$ . The expression is expanded as given below :

$$(1/2\mathbf{T} + 1/2\mathbf{t})^2 = (1/2\mathbf{T} + 1/2\mathbf{t}) \times (1/2\mathbf{T} + 1/2\mathbf{t}) = 1/4\mathbf{TT} + 1/2\mathbf{Tt} + 1/4\mathbf{tt}$$

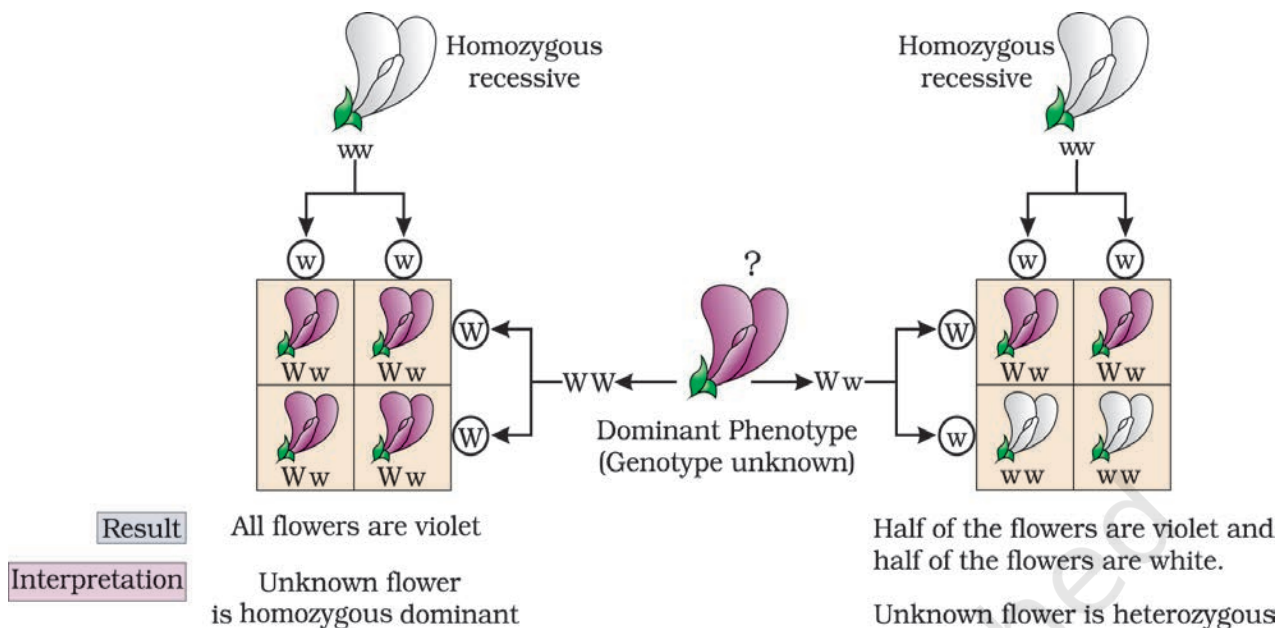
Mendel self-pollinated the  $F_2$  plants and found that dwarf  $F_2$  plants continued to generate dwarf plants in  $F_3$  and  $F_4$  generations. He concluded that the genotype of the dwarfs was homozygous – **tt**. What do you think he would have got had he self-pollinated a tall  $F_2$  plant?

From the preceding paragraphs it is clear that though the genotypic ratios can be calculated using mathematical probability, by simply looking at the phenotype of a dominant trait, it is not possible to know the genotypic composition. That is, for example, whether a tall plant from  $F_1$  or  $F_2$  has **TT** or **Tt** composition, cannot be predicted. Therefore, to determine the genotype of a tall plant at  $F_2$ , Mendel crossed the tall plant from  $F_2$  with a dwarf plant. This he called a **test cross**. In a typical test cross an organism (pea plants here) showing a dominant phenotype (and whose genotype is to be determined) is crossed with the recessive parent instead of self-crossing. The progenies of such a cross can easily be analysed to predict the genotype of the test organism. Figure 4.5 shows the results of typical test cross where violet colour flower (W) is dominant over white colour flower (w).

*Using Punnett square, try to find out the nature of offspring of a test cross.*

*What ratio did you get?*

*Using the genotypes of this cross, can you give a general definition for*



**Figure 4.5** Diagrammatic representation of a test cross

a test cross?

Based on his observations on monohybrid crosses Mendel proposed two general rules to consolidate his understanding of inheritance in monohybrid crosses. Today these rules are called the **Principles or Laws of Inheritance**: the First Law or **Law of Dominance** and the Second Law or **Law of Segregation**.

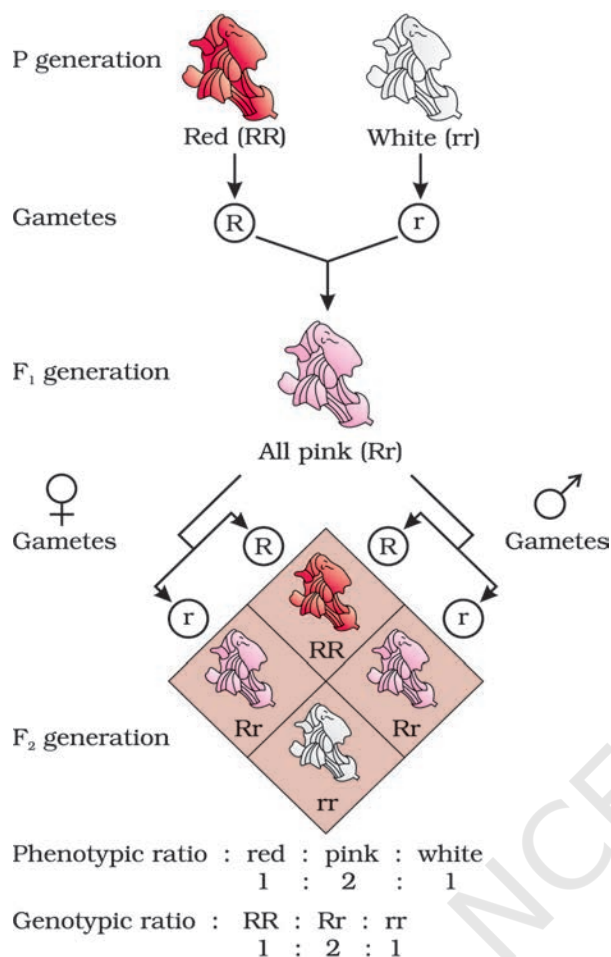
#### 4.2.1 Law of Dominance

- (i) Characters are controlled by discrete units called **factors**.
- (ii) Factors occur in pairs.
- (iii) In a dissimilar pair of factors one member of the pair dominates (dominant) the other (recessive).

The law of dominance is used to explain the expression of only one of the parental characters in a monohybrid cross in the  $F_1$  and the expression of both in the  $F_2$ . It also explains the proportion of 3:1 obtained at the  $F_2$ .

#### 4.2.2 Law of Segregation

This law is based on the fact that the alleles do not show any blending and that both the characters are recovered as such in the  $F_2$  generation though one of these is not seen at the  $F_1$  stage. Though the parents contain two alleles during gamete formation, the factors or alleles of a pair segregate from each other such that a gamete receives only one of the two factors. Of course, a homozygous parent produces all gametes that are similar while a heterozygous one produces two kinds of gametes each having one allele with equal proportion.



**Figure 4.6** Results of monohybrid cross in the plant Snapdragon, where one allele is incompletely dominant over the other allele

#### 4.2.2.1 Incomplete Dominance

When experiments on peas were repeated using other traits in other plants, it was found that sometimes the F<sub>1</sub> had a phenotype that did not resemble either of the two parents and was in between the two. The inheritance of flower colour in the dog flower (snapdragon or *Antirrhinum sp.*) is a good example to understand incomplete dominance. In a cross between true-breeding red-flowered (**RR**) and true-breeding white-flowered plants (**rr**), the F<sub>1</sub> (**Rr**) was pink (Figure 4.6). When the F<sub>1</sub> was self-pollinated the F<sub>2</sub> resulted in the following ratio 1 (**RR**) Red : 2 (**Rr**) Pink : 1 (**rr**) White. Here the genotype ratios were exactly as we would expect in any mendelian monohybrid cross, but the phenotype ratios had changed from the 3:1 dominant : recessive ratio. What happened was that **R** was not completely dominant over **r** and this made it possible to distinguish **Rr** as pink from **RR** (red) and **rr** (white).

#### Explanation of the concept of dominance:

What exactly is dominance? Why are some alleles dominant and some recessive? To tackle these questions, we must understand what a gene does. Every gene, as you know by now, contains the information to express a particular trait. In a diploid organism, there are two copies of each gene, i.e., as a pair of alleles. Now, these two alleles need not always be identical, as in a heterozygote. One of them may be different due to some changes that it has undergone (about which you will read further on, and in the next chapter) which modifies the information that particular allele contains.

Let's take an example of a gene that contains the information for producing an enzyme. Now there are two copies of this gene, the two allelic forms. Let us assume (as is more common) that the normal allele produces the normal enzyme that is needed for the transformation of a

substrate S. Theoretically, the modified allele could be responsible for production of –

- (i) the normal/less efficient enzyme, or
- (ii) a non-functional enzyme, or
- (iii) no enzyme at all





In the first case, the modified allele is equivalent to the unmodified allele, i.e., it will produce the same phenotype/trait, i.e., result in the transformation of substrate S. Such equivalent allele pairs are very common. But, if the allele produces a non-functional enzyme or no enzyme, the phenotype may be effected. The phenotype/trait will only be dependent on the functioning of the unmodified allele. The unmodified (functioning) allele, which represents the original phenotype is the dominant allele and the modified allele is generally the recessive allele. Hence, in the example above the recessive trait is seen due to non-functional enzyme or because no enzyme is produced.

#### 4.2.2.2 Co-dominance

Till now we were discussing crosses where the  $F_1$  resembled either of the two parents (dominance) or was in-between (incomplete dominance). But, in the case of co-dominance the  $F_1$  generation resembles both parents. A good example is different types of red blood cells that determine ABO blood grouping in human beings. ABO blood groups are controlled by the gene *I*. The plasma membrane of the red blood cells has sugar polymers that protrude from its surface and the kind of sugar is controlled by the gene. The gene (*I*) has three alleles  $I^A$ ,  $I^B$  and *i*. The alleles  $I^A$  and  $I^B$  produce a slightly different form of the sugar while allele *i* does not produce any sugar. Because humans are diploid organisms, each person possesses any two of the three *I* gene alleles.  $I^A$  and  $I^B$  are completely dominant over *i*, in other words when  $I^A$  and *i* are present only  $I^A$  expresses (because *i* does not produce any sugar), and when  $I^B$  and *i* are present  $I^B$  expresses. But when  $I^A$  and  $I^B$  are present together they both express their own types of sugars: this is because of co-dominance. Hence red blood cells have both A and B types of sugars. Since there are three different alleles, there are six different combinations of these three alleles that are possible, and therefore, a total of six different genotypes of the human ABO blood types (Table 4.2). *How many phenotypes are possible?*

**Table 4.2: Table Showing the Genetic Basis of Blood Groups in Human Population**

Allele from Parent 1	Allele from Parent 2	Genotype of offspring	Blood types of offspring
$I^A$	$I^A$	$I^A I^A$	A
$I^A$	$I^B$	$I^A I^B$	AB
$I^A$	<i>i</i>	$I^A i$	A
$I^B$	$I^A$	$I^A I^B$	AB
$I^B$	$I^B$	$I^B I^B$	B
$I^B$	<i>i</i>	$I^B i$	B
<i>i</i>	<i>i</i>	<i>i i</i>	O



Do you realise that the example of ABO blood grouping also provides a good example of **multiple alleles**? Here you can see that there are more than two, i.e., three alleles, governing the same character. Since in an individual only two alleles can be present, multiple alleles can be found only when population studies are made.

Occasionally, a single gene product may produce more than one effect. For example, starch synthesis in pea seeds is controlled by one gene. It has two alleles (**B** and **b**). Starch is synthesised effectively by **BB** homozygotes and therefore, large starch grains are produced. In contrast, **bb** homozygotes have lesser efficiency in starch synthesis and produce smaller starch grains. After maturation of the seeds, **BB** seeds are round and the **bb** seeds are wrinkled. Heterozygotes produce round seeds, and so **B** seems to be the dominant allele. But, the starch grains produced are of intermediate size in **Bb** seeds. So if starch grain size is considered as the phenotype, then from this angle, the alleles show incomplete dominance.

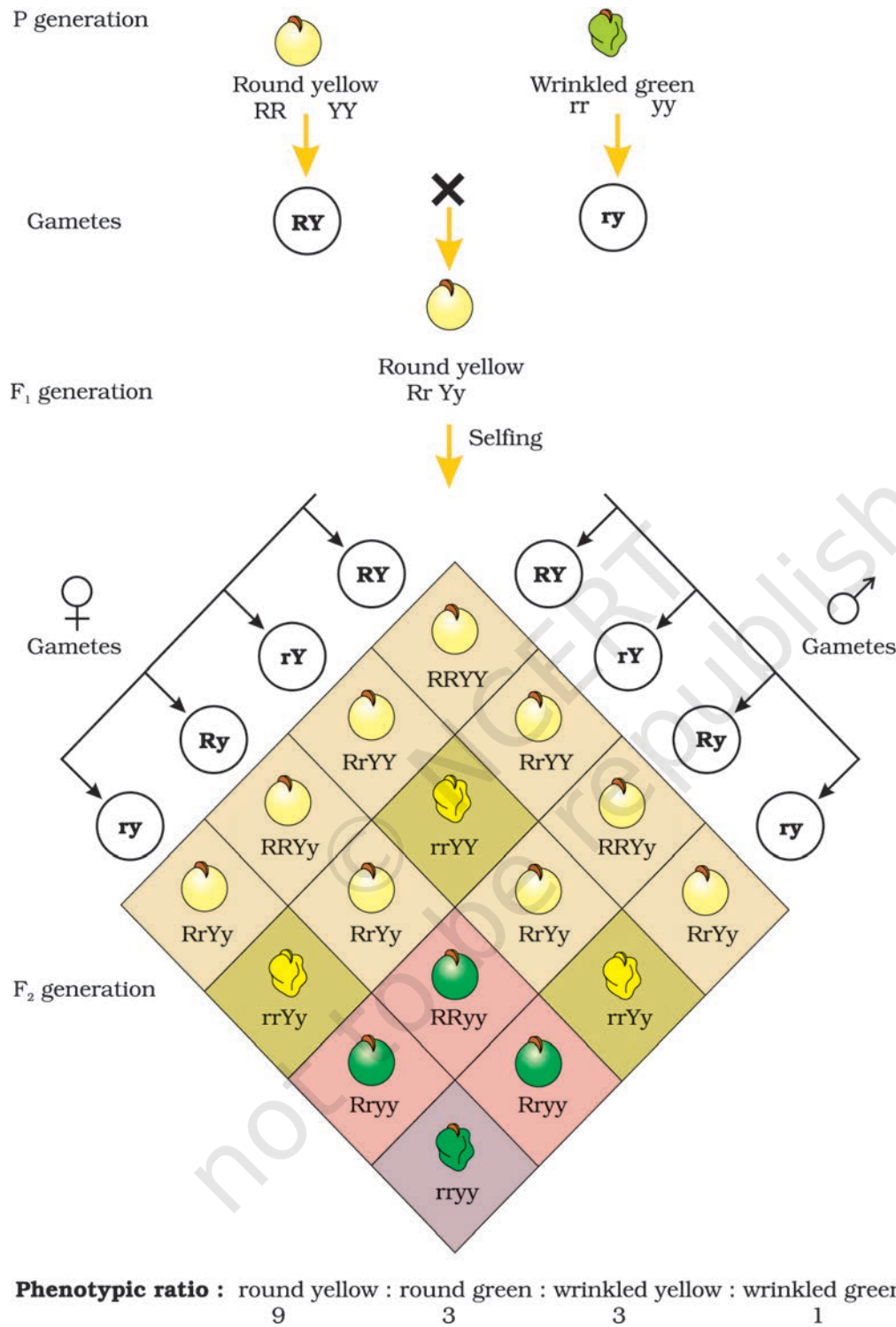
Therefore, dominance is not an autonomous feature of a gene or the product that it has information for. It depends as much on the gene product and the production of a particular phenotype from this product as it does on the particular phenotype that we choose to examine, in case more than one phenotype is influenced by the same gene.

### 4.3 INHERITANCE OF TWO GENES

Mendel also worked with and crossed pea plants that differed in two characters, as is seen in the cross between a pea plant that has seeds with yellow colour and round shape and one that had seeds of green colour and wrinkled shape (Figure 4.7). Mendel found that the seeds resulting from the crossing of the parents, had yellow coloured and round shaped seeds. *Here can you tell which of the characters in the pairs yellow/green colour and round/wrinkled shape was dominant?*

Thus, yellow colour was dominant over green and round shape dominant over wrinkled. These results were identical to those that he got when he made separate monohybrid crosses between yellow and green seeded plants and between round and wrinkled seeded plants.

Let us use the genotypic symbols **Y** for dominant yellow seed colour and **y** for recessive green seed colour, **R** for round shaped seeds and **r** for wrinkled seed shape. The genotype of the parents can then be written as **RRYY** and **rryy**. The cross between the two plants can be written down as in Figure 4.7 showing the genotypes of the parent plants. The gametes **RY** and **ry** unite on fertilisation to produce the  $F_1$  hybrid **RrYy**. When Mendel self hybridised the  $F_1$  plants he found that  $3/4^{\text{th}}$  of  $F_2$  plants had yellow seeds and  $1/4^{\text{th}}$  had green. The yellow and green colour segregated in a 3:1 ratio. Round and wrinkled seed shape also segregated in a 3:1 ratio; just like in a monohybrid cross.



**Figure 4.7** Results of a dihybrid cross where the two parents differed in two pairs of contrasting traits: seed colour and seed shape



### 4.3.1 Law of Independent Assortment

In the dihybrid cross (Figure 4.7), the phenotypes round, yellow; wrinkled, yellow; round, green and wrinkled, green appeared in the ratio 9:3:3:1. Such a ratio was observed for several pairs of characters that Mendel studied.

The ratio of 9:3:3:1 can be derived as a combination series of 3 yellow: 1 green, with 3 round : 1 wrinkled. This derivation can be written as follows:

(3 Round : 1 Wrinkled) (3 Yellow : 1 Green) = 9 Round, Yellow : 3 Wrinkled, Yellow: 3 Round, Green : 1 Wrinkled, Green

Based upon such observations on **dihybrid crosses** (crosses between plants differing in two traits) Mendel proposed a second set of generalisations that we call Mendel's Law of Independent Assortment. The law states that 'when two pairs of traits are combined in a hybrid, segregation of one pair of characters is independent of the other pair of characters'.

The Punnett square can be effectively used to understand the independent segregation of the two pairs of genes during meiosis and the production of eggs and pollen in the  $F_1$  **RrYy** plant. Consider the segregation of one pair of genes **R** and **r**. Fifty per cent of the gametes have the gene **R** and the other 50 per cent have **r**. Now besides each gamete having either **R** or **r**, it should also have the allele **Y** or **y**. The important thing to remember here is that segregation of 50 per cent **R** and 50 per cent **r** is *independent* from the segregation of 50 per cent **Y** and 50 per cent **y**. Therefore, 50 per cent of the **r** bearing gametes has **Y** and the other 50 per cent has **y**. Similarly, 50 per cent of the **R** bearing gametes has **Y** and the other 50 per cent has **y**. Thus there are four genotypes of gametes (four types of pollen and four types of eggs). The four types are **RY**, **Ry**, **rY** and **ry** each with a frequency of 25 per cent or  $1/4^{\text{th}}$  of the total gametes produced. When you write down the four types of eggs and pollen on the two sides of a Punnett square it is very easy to derive the composition of the zygotes that give rise to the  $F_2$  plants (Figure 4.7). *Although there are 16 squares how many different types of genotypes and phenotypes are formed? Note them down in the format given.*

Can you, using the Punnett square data work out the genotypic ratio at the  $F_2$  stage and fill in the format given? Is the genotypic ratio also 9:3:3:1?

64

S.No.	Genotypes found in $F_2$	Their expected Phenotypes

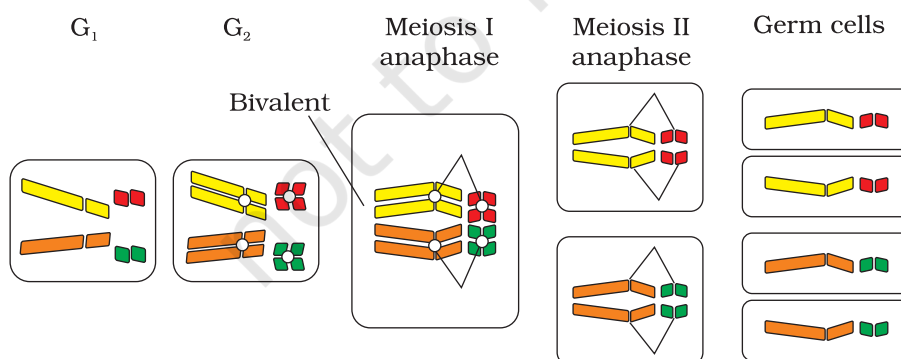
### 4.3.2 Chromosomal Theory of Inheritance

Mendel published his work on inheritance of characters in 1865 but for several reasons, it remained unrecognised till 1900. Firstly,



communication was not easy (as it is now) in those days and his work could not be widely publicised. Secondly, his concept of **genes** (or **factors**, in Mendel's words) as stable and discrete units that controlled the expression of traits and, of the pair of alleles which did not 'blend' with each other, was not accepted by his contemporaries as an explanation for the apparently continuous variation seen in nature. Thirdly, Mendel's approach of using mathematics to explain biological phenomena was totally new and unacceptable to many of the biologists of his time. Finally, though Mendel's work suggested that factors (genes) were discrete units, he could not provide any physical proof for the existence of factors or say what they were made of.

In 1900, three Scientists (de Vries, Correns and von Tschermak) independently rediscovered Mendel's results on the inheritance of characters. Also, by this time due to advancements in microscopy that were taking place, scientists were able to carefully observe cell division. This led to the discovery of structures in the nucleus that appeared to double and divide just before each cell division. These were called **chromosomes** (*colored bodies*, as they were visualised by staining). By 1902, the chromosome movement during meiosis had been worked out. Walter Sutton and Theodore Boveri noted that the behaviour of chromosomes was parallel to the behaviour of genes and used chromosome movement (Figure 4.8) to explain Mendel's laws (Table 4.3). Recall that you have studied the behaviour of chromosomes during mitosis (equational division) and during meiosis (reduction division). The important things to remember are that chromosomes as well as genes occur in pairs. The two alleles of a gene pair are located on homologous sites on homologous chromosomes.



**Figure 4.8** Meiosis and germ cell formation in a cell with four chromosomes. Can you see how chromosomes segregate when germ cells are formed?



**Table 4.3: A Comparison between the Behaviour of Chromosomes and Genes**

A	B
<i>Occur in pairs</i>	<i>Occur in pairs</i>
<i>Segregate at the time of gamete formation such that only one of each pair is transmitted to a gamete</i>	<i>Segregate at gamete formation and only one of each pair is transmitted to a gamete</i>
<i>Independent pairs segregate independently of each other</i>	<i>One pair segregates independently of another pair</i>

*Can you tell which of these columns A or B represent the chromosome and which represents the gene? How did you decide?*

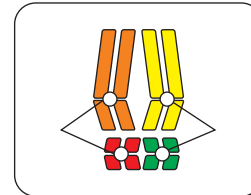
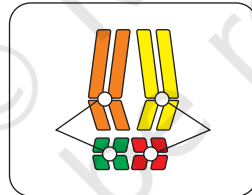
During Anaphase of meiosis I, the two chromosome pairs can align at the metaphase plate independently of each other (Figure 4.9). To understand this, compare the chromosomes of four different colour in the left and right columns. In the left column (Possibility I) orange and green is segregating together. But in the right hand column (Possibility II) the orange chromosome is segregating with the red chromosomes.

**Possibility I**  
One long orange and short green chromosome and long yellow and short red chromosome at the same pole

**Possibility II**  
One long orange and short red chromosome and long yellow and short green chromosome at the same pole

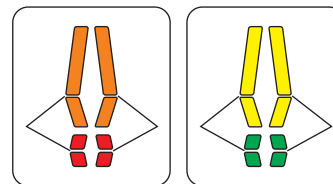
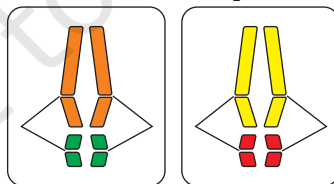
Meiosis I - anaphase

Meiosis I - anaphase



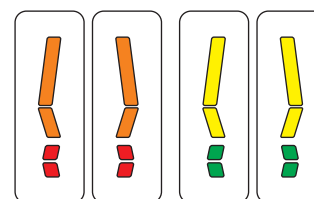
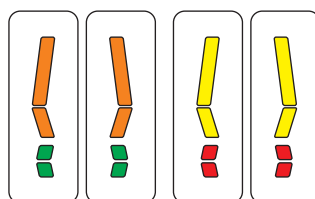
Meiosis II - anaphase

Meiosis II - anaphase



Germ cells

Germ cells

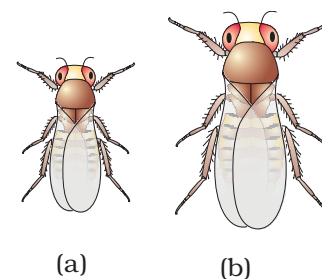


**Figure 4.9** Independent assortment of chromosomes



Sutton and Boveri argued that the pairing and separation of a pair of chromosomes would lead to the segregation of a pair of factors they carried. Sutton united the knowledge of chromosomal segregation with Mendelian principles and called it the **chromosomal theory of inheritance**.

Following this synthesis of ideas, experimental verification of the chromosomal theory of inheritance by Thomas Hunt Morgan and his colleagues, led to discovering the basis for the variation that sexual reproduction produced. Morgan worked with the tiny fruit flies, *Drosophila melanogaster* (Figure 4.10), which were found very suitable for such studies. They could be grown on simple synthetic medium in the laboratory. They complete their life cycle in about two weeks, and a single mating could produce a large number of progeny flies. Also, there was a clear differentiation of the sexes – the male and female flies are easily distinguishable. Also, it has many types of hereditary variations that can be seen with low power microscopes.



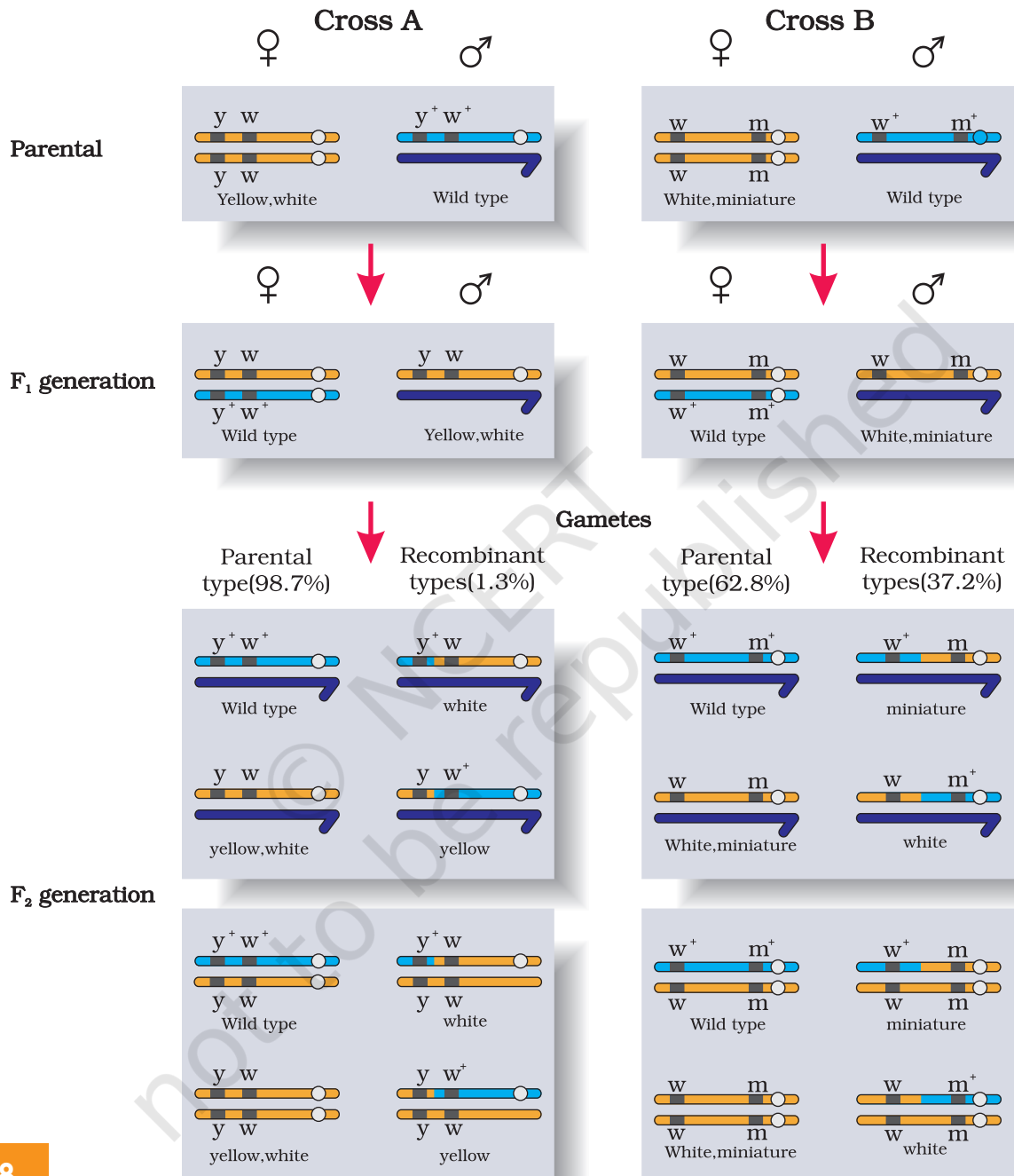
**Figure 4.10** *Drosophila melanogaster* (a) Male  
(b) Female

### 4.3.3 Linkage and Recombination

Morgan carried out several dihybrid crosses in *Drosophila* to study genes that were sex-linked. The crosses were similar to the dihybrid crosses carried out by Mendel in peas. For example Morgan hybridised yellow-bodied, white-eyed females to brown-bodied, red-eyed males and intercrossed their  $F_1$  progeny. He observed that the two genes did not segregate independently of each other and the  $F_2$  ratio deviated very significantly from the 9:3:3:1 ratio (expected when the two genes are independent).

Morgan and his group knew that the genes were located on the X chromosome (Section 4.4) and saw quickly that when the two genes in a dihybrid cross were situated on the same chromosome, the proportion of parental gene combinations were much higher than the non-parental type. Morgan attributed this due to the physical association or linkage of the two genes and coined the term **linkage** to describe this physical association of genes on a chromosome and the term **recombination** to describe the generation of non-parental gene combinations (Figure 4.11). Morgan and his group also found that even when genes were grouped on the same chromosome, some genes were very tightly linked (showed very low recombination) (Figure 4.11, Cross A) while others were loosely linked (showed higher recombination) (Figure 4.11, Cross B). For example he found that the genes white and yellow were very tightly linked and showed only 1.3 per cent recombination while white and miniature wing showed 37.2 per cent recombination. His student Alfred Sturtevant used the frequency of recombination between gene pairs on the same chromosome as a measure of the distance between genes and 'mapped' their position on the chromosome. Today genetic maps

are extensively used as a starting point in the sequencing of whole genomes as was done in the case of the Human Genome Sequencing Project, described later.



**Figure 4.11** Linkage: Results of two dihybrid crosses conducted by Morgan. Cross A shows crossing between gene  $y$  and  $w$ ; Cross B shows crossing between genes  $w$  and  $m$ . Here dominant wild type alleles are represented with (+) sign in superscript Note: The strength of linkage between  $y$  and  $w$  is higher than  $w$  and  $m$ .





## 4.4 POLYGENIC INHERITANCE

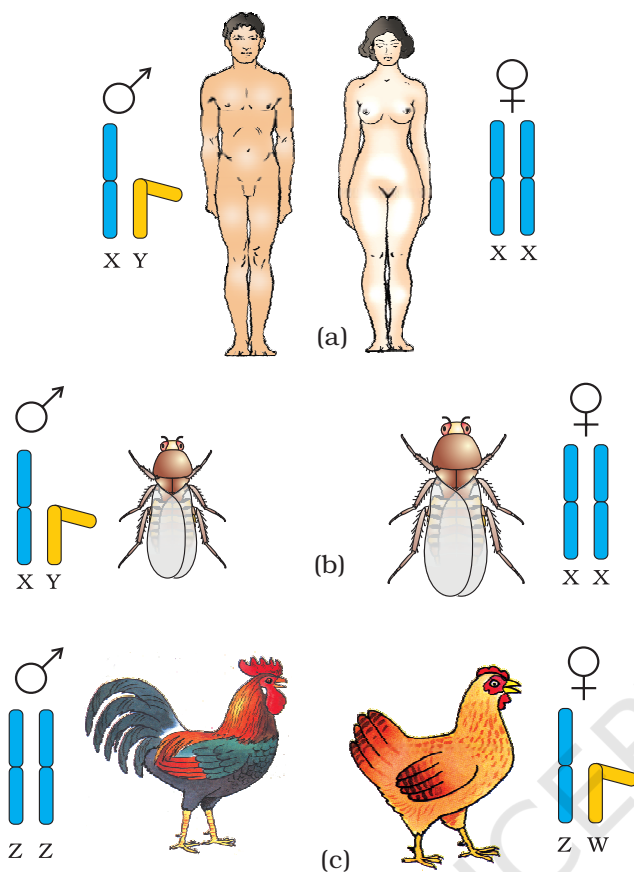
Mendel's studies mainly described those traits that have distinct alternate forms such as flower colour which are either purple or white. But if you look around you will find that there are many traits which are not so distinct in their occurrence and are spread across a gradient. For example, in humans we don't just have tall or short people as two distinct alternatives but a whole range of possible heights. Such traits are generally controlled by three or more genes and are thus called as polygenic traits. Besides the involvement of multiple genes polygenic inheritance also takes into account the influence of environment. Human skin colour is another classic example for this. In a polygenic trait the phenotype reflects the contribution of each allele, i.e., the effect of each allele is additive. To understand this better let us assume that three genes A, B, C control skin colour in human with the dominant forms A, B and C responsible for dark skin colour and the recessive forms a, b and c for light skin colour. The genotype with all the dominant alleles (AABBCC) will have the darkest skin colour and that with all the recessive alleles (aabbcc) will have the lightest skin colour. As expected the genotype with three dominant alleles and three recessive alleles will have an intermediate skin colour. In this manner the number of each type of alleles in the genotype would determine the darkness or lightness of the skin in an individual.

## 4.5 PLEIOTROPY

We have so far seen the effect of a gene on a single phenotype or trait. There are however instances where a single gene can exhibit multiple phenotypic expression. Such a gene is called a pleiotropic gene. The underlying mechanism of pleiotropy in most cases is the effect of a gene on metabolic pathways which contribute towards different phenotypes. An example of this is the disease phenylketonuria, which occurs in humans. The disease is caused by mutation in the gene that codes for the enzyme phenyl alanine hydroxylase (single gene mutation). This manifests itself through phenotypic expression characterised by mental retardation and a reduction in hair and skin pigmentation.

## 4.6 SEX DETERMINATION

The mechanism of sex determination has always been a puzzle before the geneticists. The initial clue about the genetic/chromosomal mechanism of sex determination can be traced back to some of the experiments carried out in insects. In fact, the cytological observations made in a number of insects led to the development of the concept of genetic/chromosomal basis of sex-determination. Henking (1891) could trace a specific nuclear structure all through spermatogenesis in a few insects, and it was also observed by him that 50 per cent of the sperm received this structure after spermatogenesis, whereas the other 50 per cent sperm did not receive it. Henking gave a name to this structure as the **X body** but he could not explain its significance. Further investigations by other scientists led to the conclusion that the 'X body' of Henking was in fact a chromosome



**Figure 4.12** Determination of sex by chromosomal differences: (a,b) Both in humans and in *Drosophila*, the female has a pair of XX chromosomes (homogametic) and the male XY (heterogametic) composition; (c) In many birds, female has a pair of dissimilar chromosomes ZW and male two similar ZZ chromosomes

and that is why it was given the name X-chromosome. It was also observed that in a large number of insects the mechanism of sex determination is of the XO type, i.e., all eggs bear an additional X-chromosome besides the other chromosomes (autosomes). On the other hand, some of the sperms bear the X-chromosome whereas some do not. Eggs fertilised by sperm having an X-chromosome become females and, those fertilised by sperms that do not have an X-chromosome become males. *Do you think the number of chromosomes in the male and female are equal?* Due to the involvement of the X-chromosome in the determination of sex, it was designated to be the **sex chromosome**, and the rest of the chromosomes were named as **autosomes**. Grasshopper is an example of XO type of sex determination in which the males have only one X-chromosome besides the autosomes, whereas females have a pair of X-chromosomes.

These observations led to the investigation of a number of species to understand the mechanism of sex determination. In a number of other insects and mammals including man, XY type of sex determination is seen where both male and female have same number of chromosomes. Among the males an X-chromosome is present but its counter part is distinctly smaller and called the Y-chromosome. Females, however, have a pair of X-chromosomes. Both males and females bear

same number of autosomes. Hence, the males have autosomes plus XY, while female have autosomes plus XX. In human beings and in *Drosophila* the males have one X and one Y chromosome, whereas females have a pair of X-chromosomes besides autosomes (Figure 4.12 a, b).

In the above description you have studied about two types of sex determining mechanisms, i.e., XO type and XY type. But in both cases males produce two different types of gametes, (a) either with or without X-chromosome or (b) some gametes with X-chromosome and some with Y-chromosome. Such types of sex determination mechanism is designated to be the example of **male heterogamety**. In some other organisms, e.g., birds, a different mechanism of sex determination is observed (Figure 4.12 c). In this case the total number of chromosome is same in both males and females. But two different types of gametes in terms of the sex



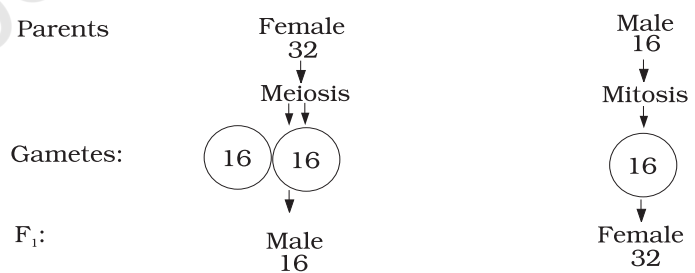
chromosomes, are produced by females, i.e., **female heterogamety**. In order to have a distinction with the mechanism of sex determination described earlier, the two different sex chromosomes of a female bird has been designated to be the Z and W chromosomes. In these organisms the females have one Z and one W chromosome, whereas males have a pair of Z-chromosomes besides the autosomes.

#### 4.6.1 Sex Determination in Humans

It has already been mentioned that the sex determining mechanism in case of humans is XY type. Out of 23 pairs of chromosomes present, 22 pairs are exactly same in both males and females; these are the autosomes. A pair of X-chromosomes are present in the female, whereas the presence of an X and Y chromosome are determinant of the male characteristic. During spermatogenesis among males, two types of gametes are produced. 50 per cent of the total sperm produced carry the X-chromosome and the rest 50 per cent has Y-chromosome besides the autosomes. Females, however, produce only one type of ovum with an X-chromosome. There is an equal probability of fertilisation of the ovum with the sperm carrying either X or Y chromosome. In case the ovum fertilises with a sperm carrying X-chromosome the zygote develops into a female (XX) and the fertilisation of ovum with Y-chromosome carrying sperm results into a male offspring. Thus, it is evident that it is the genetic makeup of the sperm that determines the sex of the child. It is also evident that in each pregnancy there is always 50 per cent probability of either a male or a female child. It is unfortunate that in our society women are blamed for giving birth to female children and have been ostracised and ill-treated because of this false notion.

#### 4.6.2 Sex Determination in Honey Bee

The sex determination in honey bee is based on the number of sets of chromosomes an individual receives. An offspring formed from the union of a sperm and an egg develops as a female (queen or worker), and an unfertilised egg develops as a male (drone) by means of parthenogenesis. This means that the males have half the number of chromosomes than that of a female. The females are diploid having 32 chromosomes and males are haploid, i.e., having 16 chromosomes. This is called as haplodiploid sex-determination system and has special characteristic features such as the males produce sperms by mitosis (Figure 4.13), they do not have father and thus cannot have sons, but have a grandfather and can have grandsons.



**Figure 4.13** Sex determination in honey bee

How is the sex-determination mechanism different in the birds?  
*Is the sperm or the egg responsible for the sex of the chicks?*

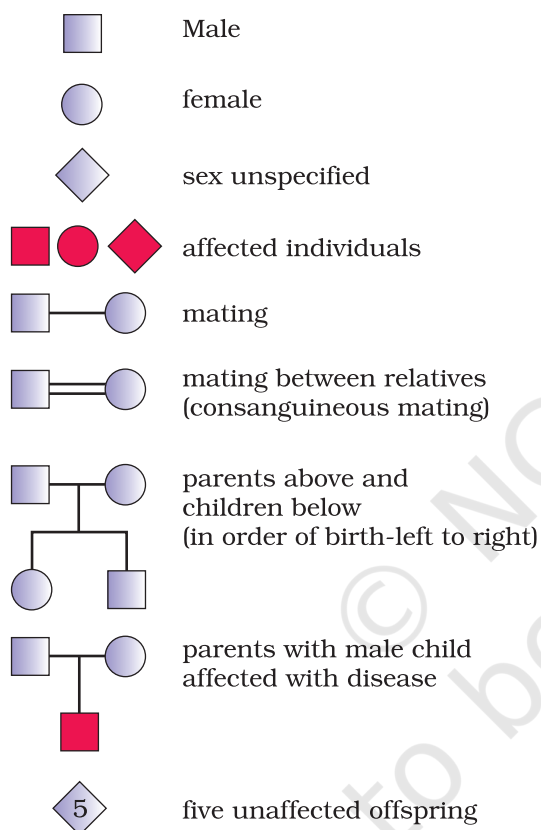
## 4.7 MUTATION

Mutation is a phenomenon which results in alteration of DNA sequences and consequently results in changes in the genotype and the phenotype of an organism. In addition to recombination, mutation is another phenomenon that leads to variation in DNA.

As you will learn in Chapter 5, one DNA helix runs continuously from one end to the other in each chromatid, in a highly supercoiled form. Therefore loss (deletions) or gain (insertion/duplication) of a segment of DNA, result in alteration in chromosomes. Since genes are known to be located on chromosomes, alteration in chromosomes results in abnormalities or aberrations. Chromosomal aberrations are commonly observed in cancer cells.

In addition to the above, mutation also arise due to change in a single base pair of DNA. This is known as point mutation. A classical example of such a mutation is sickle cell anemia. Deletions and insertions of base pairs of DNA, causes frame-shift mutations (see Chapter 5).

The mechanism of mutation is beyond the scope of this discussion, at this level. However, there are many chemical and physical factors that induce mutations. These are referred to as mutagens. UV radiations can cause mutations in organisms – it is a mutagen.



**Figure 4.13** Symbols used in the human pedigree analysis

## 4.8 GENETIC DISORDERS

### 4.8.1 Pedigree Analysis

The idea that disorders are inherited has been prevailing in the human society since long. This was based on the heritability of certain characteristic features in families. After the rediscovery of Mendel's work the practice of analysing inheritance pattern of traits in human beings began. Since it is evident that control crosses that can be performed in pea plant or some other organisms, are not possible in case of human beings, study of the family history about inheritance of a particular trait provides an

alternative. Such an analysis of traits in a several of generations of a family is called the **pedigree analysis**. In the pedigree analysis the inheritance of a particular trait is represented in the family tree over generations.

In human genetics, pedigree study provides a strong tool, which is utilised to trace the inheritance of a specific trait, abnormality or disease. Some of the important standard symbols used in the pedigree analysis have been shown in Figure 4.13.

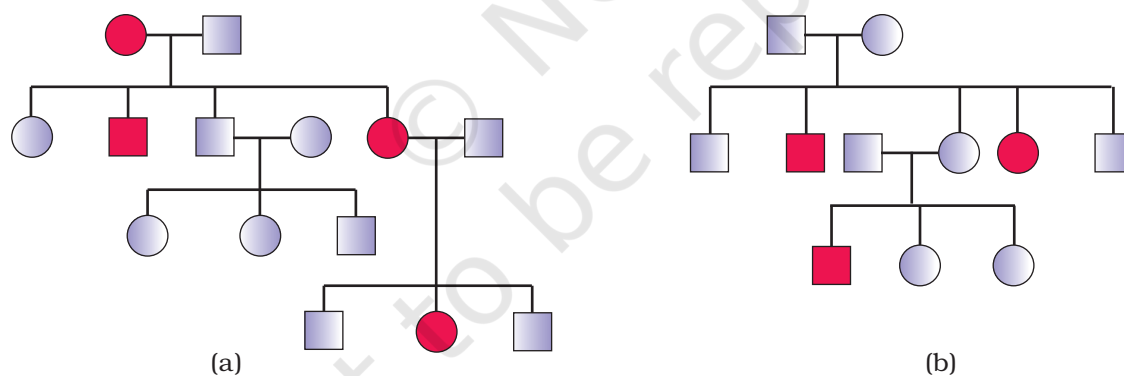
As you have studied in this chapter, each and every feature in any organism is controlled by one or the other gene located on the DNA present



in the chromosome. DNA is the carrier of genetic information. It is hence transmitted from one generation to the other without any change or alteration. However, changes or alteration do take place occasionally. Such an alteration or change in the genetic material is referred to as mutation. A number of disorders in human beings have been found to be associated with the inheritance of changed or altered genes or chromosomes.

#### 4.8.2 Mendelian Disorders

Broadly, genetic disorders may be grouped into two categories – Mendelian disorders and Chromosomal disorders. Mendelian disorders are mainly determined by alteration or mutation in the single gene. These disorders are transmitted to the offspring on the same lines as we have studied in the principle of inheritance. The pattern of inheritance of such Mendelian disorders can be traced in a family by the pedigree analysis. Most common and prevalent Mendelian disorders are Haemophilia, Cystic fibrosis, Sickle-cell anaemia, Colour blindness, Phenylketonuria, Thalassemia, etc. It is important to mention here that such Mendelian disorders may be dominant or recessive. By pedigree analysis one can easily understand whether the trait in question is dominant or recessive. Similarly, the trait may also be linked to the sex chromosome as in case of haemophilia. It is evident that this X-linked recessive trait shows transmission from carrier female to male progeny. A representative pedigree is shown in Figure 4.14 for dominant and recessive traits. Discuss with your teacher and design pedigrees for characters linked to both autosomes and sex chromosome.



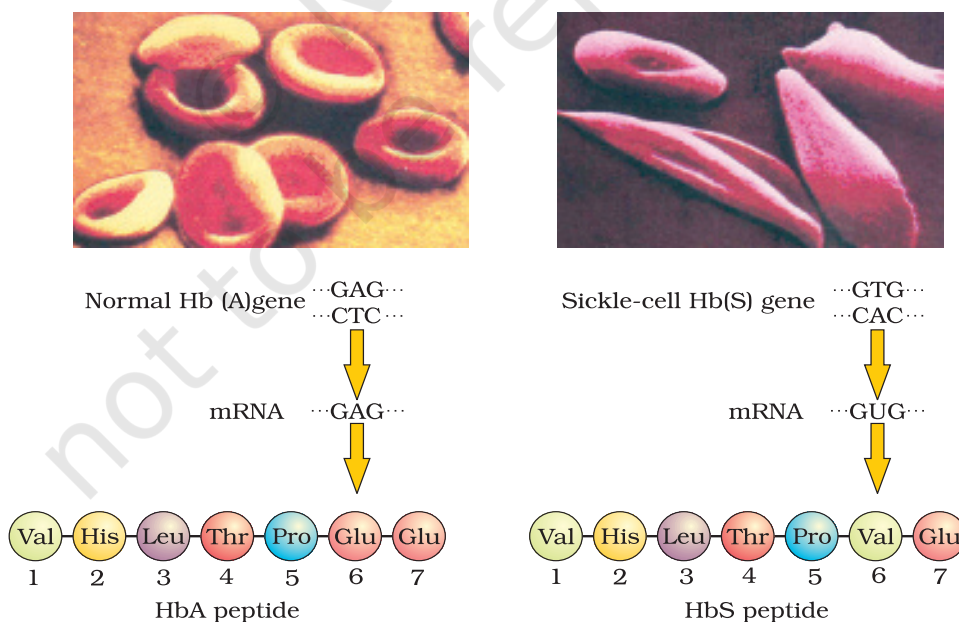
**Figure 4.14** Representative pedigree analysis of (a) Autosomal dominant trait (for example: Myotonic dystrophy) (b) Autosomal recessive trait (for example: Sickle-cell anaemia)

**Colour Blidness** : It is a sex-linked recessive disorder due to defect in either red or green cone of eye resulting in failure to discriminate between red and green colour. This defect is due to mutation in certain genes present in the X chromosome. It occurs in about 8 per cent of males and only about 0.4 per cent of females. This is because the genes that lead to red-green colour blindness are on the X chromosome. Males have only one X chromosome and females have two. The son of a woman who carries

the gene has a 50 per cent chance of being colour blind. The mother is not herself colour blind because the gene is recessive. That means that its effect is suppressed by her matching dominant normal gene. A daughter will not normally be colour blind, unless her mother is a carrier and her father is colour blind.

**Haemophilia** : This sex linked recessive disease, which shows its transmission from unaffected carrier female to some of the male progeny has been widely studied. In this disease, a single protein that is a part of the cascade of proteins involved in the clotting of blood is affected. Due to this, in an affected individual a simple cut will result in non-stop bleeding. The heterozygous female (carrier) for haemophilia may transmit the disease to sons. The possibility of a female becoming a haemophilic is extremely rare because mother of such a female has to be at least carrier and the father should be haemophilic (unviable in the later stage of life). The family pedigree of Queen Victoria shows a number of haemophilic descendants as she was a carrier of the disease.

**Sickle-cell anaemia** : This is an autosome linked recessive trait that can be transmitted from parents to the offspring when both the partners are carrier for the gene (or heterozygous). The disease is controlled by a single pair of allele,  $Hb^A$  and  $Hb^S$ . Out of the three possible genotypes only homozygous individuals for  $Hb^S$  ( $Hb^S Hb^S$ ) show the diseased phenotype. Heterozygous ( $Hb^A Hb^S$ ) individuals appear apparently unaffected but they are carrier of the disease as there is 50 per cent probability of transmission of the mutant gene to the progeny, thus exhibiting sickle-cell trait (Figure 4.15). The defect is caused by the substitution of Glutamic acid



**Figure 4.15** Micrograph of the red blood cells and the amino acid composition of the relevant portion of  $\beta$ -chain of haemoglobin: (a) From a normal individual; (b) From an individual with sickle-cell anaemia



(Glu) by Valine (Val) at the sixth position of the beta globin chain of the haemoglobin molecule. The substitution of amino acid in the globin protein results due to the single base substitution at the sixth codon of the beta globin gene from GAG to GUG. The mutant haemoglobin molecule undergoes polymerisation under low oxygen tension causing the change in the shape of the RBC from biconcave disc to elongated sickle like structure (Figure 4.15).

**Phenylketonuria** : This inborn error of metabolism is also inherited as the autosomal recessive trait. The affected individual lacks an enzyme that converts the amino acid phenylalanine into tyrosine. As a result of this phenylalanine is accumulated and converted into phenylpyruvic acid and other derivatives. Accumulation of these in brain results in mental retardation. These are also excreted through urine because of its poor absorption by kidney.

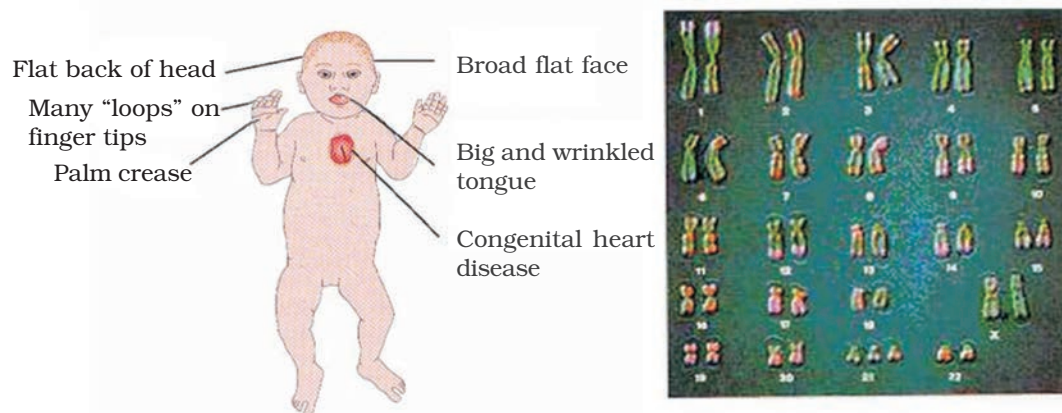
**Thalassemia** : This is also an autosome-linked recessive blood disease transmitted from parents to the offspring when both the partners are unaffected carrier for the gene (or heterozygous). The defect could be due to either mutation or deletion which ultimately results in reduced rate of synthesis of one of the globin chains ( $\alpha$  and  $\beta$  chains) that make up haemoglobin. This causes the formation of abnormal haemoglobin molecules resulting into anaemia which is characteristic of the disease. Thalassemia can be classified according to which chain of the haemoglobin molecule is affected. In  $\alpha$  Thalassemia, production of  $\alpha$  globin chain is affected while in  $\beta$  Thalassemia, production of  $\beta$  globin chain is affected.  $\alpha$  Thalassemia is controlled by two closely linked genes HBA1 and HBA2 on chromosome 16 of each parent and it is observed due to mutation or deletion of one or more of the four genes. The more genes affected, the less alpha globin molecules produced. While  $\beta$  Thalassemia is controlled by a single gene HBB on chromosome 11 of each parent and occurs due to mutation of one or both the genes. Thalassemia differs from sickle-cell anaemia in that the former is a quantitative problem of synthesising too few globin molecules while the latter is a qualitative problem of synthesising an incorrectly functioning globin.

### 4.8.3 Chromosomal Disorders

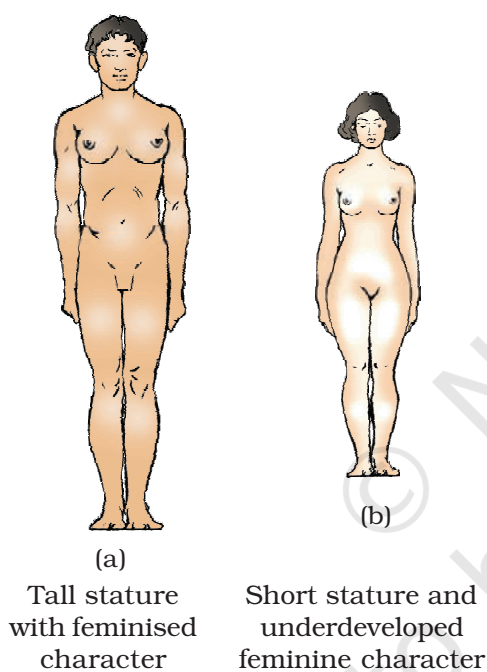
The chromosomal disorders on the other hand are caused due to absence or excess or abnormal arrangement of one or more chromosomes.

Failure of segregation of chromatids during cell division cycle results in the gain or loss of a chromosome(s), called **aneuploidy**. For example, Down's syndrome results in the gain of extra copy of chromosome 21. Similarly, Turner's syndrome results due to loss of an X chromosome in human females. Failure of cytokinesis after telophase stage of cell division results in an increase in a whole set of chromosomes in an organism and, this phenomenon is known as **polyploidy**. This condition is often seen in plants.

The total number of chromosomes in a normal human cell is 46 (23 pairs). Out of these 22 pairs are autosomes and one pair of chromosomes are sex chromosome. Sometimes, though rarely, either an additional copy of a chromosome may be included in an individual or an



**Figure 4.16** A representative figure showing an individual inflicted with Down's syndrome and the corresponding chromosomes of the individual



**Figure 4.17** Diagrammatic representation of genetic disorders due to sex chromosome composition in humans : (a) Klinefelter Syndrome; (b) Turner's Syndrome

individual may lack one of any one pair of chromosomes. These situations are known as trisomy or monosomy of a chromosome, respectively. Such a situation leads to very serious consequences in the individual. Down's syndrome, Turner's syndrome, Klinefelter's syndrome are common examples of chromosomal disorders.

**Down's Syndrome** : The cause of this genetic disorder is the presence of an additional copy of the chromosome number 21 (trisomy of 21). This disorder was first described by Langdon Down (1866). The affected individual is short statured with small round head, furrowed tongue and partially open mouth (Figure 4.16). Palm is broad with characteristic palm crease. Physical, psychomotor and mental development is retarded.

**Klinefelter's Syndrome** : This genetic disorder is also caused due to the presence of an additional copy of X-chromosome resulting into a karyotype of 47, XXY. Such an individual has overall masculine development, however, the feminine development (development of breast, i.e., Gynaecomastia) is also expressed (Figure 4.17 a). Such individuals are sterile.

**Turner's Syndrome** : Such a disorder is caused due to the absence of one of the X chromosomes, i.e., 45 with X0, Such females are sterile as ovaries are rudimentary besides other features including lack of other secondary sexual characters (Figure 4.17 b).





## SUMMARY

Genetics is a branch of biology which deals with principles of inheritance and its practices. Progeny resembling the parents in morphological and physiological features has attracted the attention of many biologists. Mendel was the first to study this phenomenon systematically. While studying the pattern of inheritance in pea plants of contrasting characters, Mendel proposed the principles of inheritance, which are today referred to as 'Mendel's Laws of Inheritance'. He proposed that the 'factors' (later named as genes) regulating the characters are found in pairs known as alleles. He observed that the expression of the characters in the offspring follow a definite pattern in different—first generations ( $F_1$ ), second ( $F_2$ ) and so on. Some characters are dominant over others. The dominant characters are expressed when factors are in heterozygous condition (Law of Dominance). The recessive characters are only expressed in homozygous conditions. The characters never blend in heterozygous condition. A recessive character that was not expressed in heterozygous condition may be expressed again when it becomes homozygous. Hence, characters segregate while formation of gametes (Law of Segregation).

Not all characters show true dominance. Some characters show incomplete, and some show co-dominance. When Mendel studied the inheritance of two characters together, it was found that the factors independently assort and combine in all permutations and combinations (Law of Independent Assortment). Different combinations of gametes are theoretically represented in a square tabular form known as 'Punnett Square'. The factors (now known as gene) on chromosomes regulating the characters are called the genotype and the physical expression of the characters is called phenotype.

After knowing that the genes are located on the chromosomes, a good correlation was drawn between Mendel's laws : segregation and assortment of chromosomes during meiosis. The Mendel's laws were extended in the form of 'Chromosomal Theory of Inheritance'. Later, it was found that Mendel's law of independent assortment does not hold true for the genes that were located on the same chromosomes. These genes were called as 'linked genes'. Closely located genes assorted together, and distantly located genes, due to recombination, assorted independently. Linkage maps, therefore, corresponded to arrangement of genes on a chromosome.

Many genes were linked to sexes also, and called as sex-linked genes. The two sexes (male and female) were found to have a set of chromosomes which were common, and another set which was different. The chromosomes which were different in two sexes were named as sex chromosomes. The remaining set was named as autosomes. In humans, a normal female has 22 pairs of autosomes and a pair of sex chromosomes (XX). A male has 22 pairs of autosomes and a pair of sex chromosome as XY. In chicken, sex chromosomes in male are ZZ, and in females are ZW.

Mutation is defined as change in the genetic material. A point mutation is a change of a single base pair in DNA. Sickle-cell anemia is caused due to change of one base in the gene coding for beta-chain of hemoglobin. Inheritable mutations can be studied by generating a pedigree of a family. Some mutations involve changes in whole set of



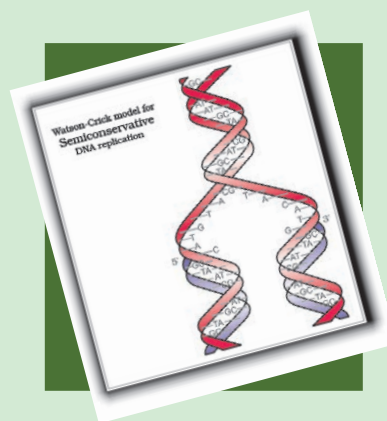
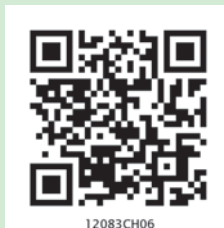
chromosomes (polyploidy) or change in a subset of chromosome number (aneuploidy). This helped in understanding the mutational basis of genetic disorders. Down's syndrome is due to trisomy of chromosome 21, where there is an extra copy of chromosome 21 and consequently the total number of chromosome becomes 47. In Turner's syndrome, one X chromosome is missing and the sex chromosome is as XO, and in Klinefelter's syndrome, the condition is XXY. These can be easily studied by analysis of Karyotypes.

## EXERCISES

- Mention the advantages of selecting pea plant for experiment by Mendel.
- Differentiate between the following –
  - Dominance and Recessive
  - Homozygous and Heterozygous
  - Monohybrid and Dihybrid.
- A diploid organism is heterozygous for 4 loci, how many types of gametes can be produced?
- Explain the Law of Dominance using a monohybrid cross.
- Define and design a test-cross.
- Using a Punnett Square, work out the distribution of phenotypic features in the first filial generation after a cross between a homozygous female and a heterozygous male for a single locus.
- When a cross is made between tall plant with yellow seeds (TtYy) and tall plant with green seed (Ttyy), what proportions of phenotype in the offspring could be expected to be
  - tall and green.
  - dwarf and green.
- Two heterozygous parents are crossed. If the two loci are linked what would be the distribution of phenotypic features in F<sub>1</sub> generation for a dihybrid cross?
- Briefly mention the contribution of T.H. Morgan in genetics.
- What is pedigree analysis? Suggest how such an analysis, can be useful.
- How is sex determined in human beings?
- A child has blood group O. If the father has blood group A and mother blood group B, work out the genotypes of the parents and the possible genotypes of the other offsprings.
- Explain the following terms with example
  - Co-dominance
  - Incomplete dominance
- What is point mutation? Give one example.
- Who had proposed the chromosomal theory of the inheritance?
- Mention any two autosomal genetic disorders with their symptoms.

# CHAPTER 5

# MOLECULAR BASIS OF INHERITANCE



- 5.1 *The DNA*
- 5.2 *The Search for Genetic Material*
- 5.3 *RNA World*
- 5.4 *Replication*
- 5.5 *Transcription*
- 5.6 *Genetic Code*
- 5.7 *Translation*
- 5.8 *Regulation of Gene Expression*
- 5.9 *Human Genome Project*
- 5.10 *DNA Fingerprinting*

In the previous chapter, you have learnt the inheritance patterns and the genetic basis of such patterns. At the time of Mendel, the nature of those 'factors' regulating the pattern of inheritance was not clear. Over the next hundred years, the nature of the putative genetic material was investigated culminating in the realisation that DNA – deoxyribonucleic acid – is the genetic material, at least for the majority of organisms. In class XI you have learnt that nucleic acids are polymers of nucleotides.

Deoxyribonucleic acid (DNA) and ribonucleic acid (RNA) are the two types of nucleic acids found in living systems. DNA acts as the genetic material in most of the organisms. RNA though it also acts as a genetic material in some viruses, mostly functions as a messenger. RNA has additional roles as well. It functions as adapter, structural, and in some cases as a catalytic molecule. In Class XI you have already learnt the structures of nucleotides and the way these monomer units are linked to form nucleic acid polymers. In this chapter we are going to discuss the structure of DNA, its replication, the process of making RNA from DNA (transcription), the genetic code that determines the sequences of amino acids in proteins, the process of protein synthesis (translation) and elementary basis of their regulation. The determination

of complete nucleotide sequence of human genome during last decade has set in a new era of genomics. In the last section, the essentials of human genome sequencing and its consequences will also be discussed.

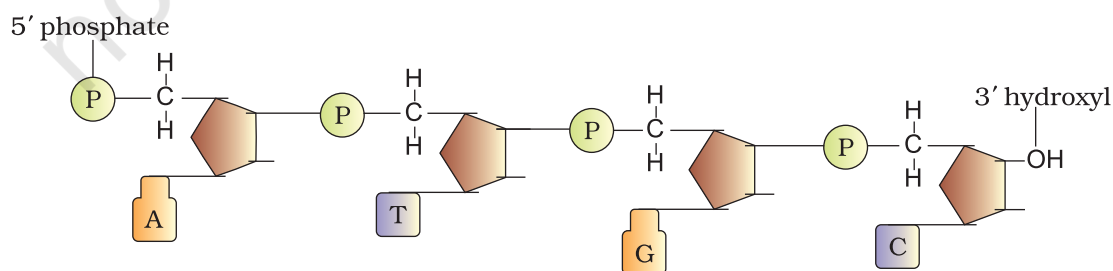
Let us begin our discussion by first understanding the structure of the most interesting molecule in the living system, that is, the DNA. In subsequent sections, we will understand that why it is the most abundant genetic material, and what its relationship is with RNA.

## 5.1 THE DNA

DNA is a long polymer of deoxyribonucleotides. The length of DNA is usually defined as number of nucleotides (or a pair of nucleotide referred to as base pairs) present in it. This also is the characteristic of an organism. For example, a bacteriophage known as  $\phi\times 174$  has 5386 nucleotides, Bacteriophage lambda has 48502 base pairs (bp), *Escherichia coli* has  $4.6 \times 10^6$  bp, and haploid content of human DNA is  $3.3 \times 10^9$  bp. Let us discuss the structure of such a long polymer.

### 5.1.1 Structure of Polynucleotide Chain

Let us recapitulate the chemical structure of a polynucleotide chain (DNA or RNA). A nucleotide has three components – a nitrogenous base, a pentose sugar (ribose in case of RNA, and deoxyribose for DNA), and a phosphate group. There are two types of nitrogenous bases – Purines (Adenine and Guanine), and Pyrimidines (Cytosine, Uracil and Thymine). Cytosine is common for both DNA and RNA and Thymine is present in DNA. Uracil is present in RNA at the place of Thymine. A nitrogenous base is linked to the OH of 1'C pentose sugar through a N-glycosidic linkage to form a nucleoside, such as adenosine or deoxyadenosine, guanosine or deoxyguanosine, cytidine or deoxycytidine and uridine or deoxythymidine. When a phosphate group is linked to OH of 5'C of a nucleoside through phosphoester linkage, a corresponding nucleotide (or deoxynucleotide depending upon the type of sugar present) is formed. Two nucleotides are linked through 3'-5' phosphodiester linkage to form a dinucleotide. More nucleotides can be joined in such a manner to form a polynucleotide chain. A polymer thus formed has at one end a free



**Figure 5.1** A Polynucleotide chain



phosphate moiety at 5'-end of sugar, which is referred to as 5'-end of polynucleotide chain. Similarly, at the other end of the polymer the sugar has a free OH of 3'C group which is referred to as 3'-end of the polynucleotide chain. The backbone of a polynucleotide chain is formed due to sugar and phosphates. The nitrogenous bases linked to sugar moiety project from the backbone (Figure 5.1).

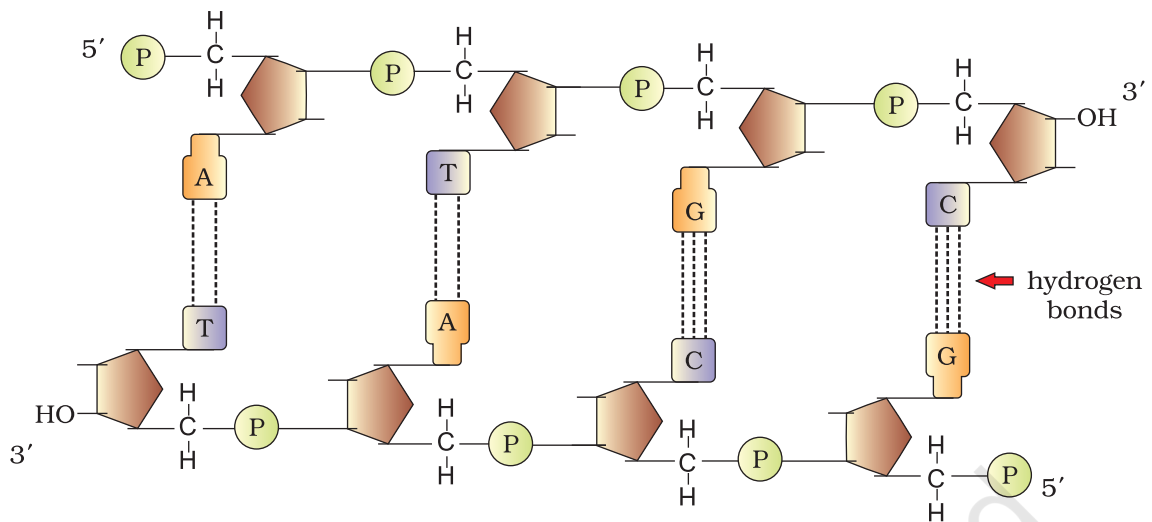
In RNA, every nucleotide residue has an additional -OH group present at 2'-position in the ribose. Also, in RNA the uracil is found at the place of thymine (5-methyl uracil, another chemical name for thymine).

DNA as an acidic substance present in nucleus was first identified by Friedrich Meischer in 1869. He named it as 'Nuclein'. However, due to technical limitation in isolating such a long polymer intact, the elucidation of structure of DNA remained elusive for a very long period of time. It was only in 1953 that James Watson and Francis Crick, based on the X-ray diffraction data produced by Maurice Wilkins and Rosalind Franklin, proposed a very simple but famous **Double Helix** model for the structure of DNA. One of the hallmarks of their proposition was base pairing between the two strands of polynucleotide chains. However, this proposition was also based on the observation of Erwin Chargaff that for a double stranded DNA, the ratios between **Adenine** and **Thymine** and **Guanine** and **Cytosine** are constant and equals one.

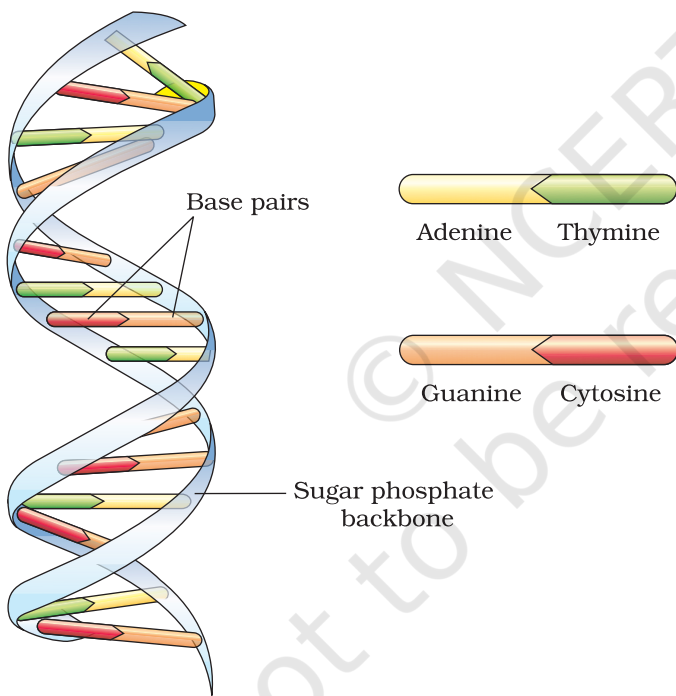
The base pairing confers a very unique property to the polynucleotide chains. They are said to be complementary to each other, and therefore if the sequence of bases in one strand is known then the sequence in other strand can be predicted. Also, if each strand from a DNA (let us call it as a parental DNA) acts as a template for synthesis of a new strand, the two double stranded DNA (let us call them as daughter DNA) thus, produced would be identical to the parental DNA molecule. Because of this, the genetic implications of the structure of DNA became very clear.

The salient features of the Double-helix structure of DNA are as follows:

- (i) It is made of two polynucleotide chains, where the backbone is constituted by sugar-phosphate, and the bases project inside.
- (ii) The two chains have anti-parallel polarity. It means, if one chain has the polarity  $5' \rightarrow 3'$ , the other has  $3' \rightarrow 5'$ .
- (iii) The bases in two strands are paired through hydrogen bond (H-bonds) forming base pairs (bp). Adenine forms two hydrogen bonds with Thymine from opposite strand and vice-versa. Similarly, Guanine is bonded with Cytosine with three H-bonds. As a result, always a purine comes opposite to a pyrimidine. This generates approximately uniform distance between the two strands of the helix (Figure 5.2).
- (iv) The two chains are coiled in a right-handed fashion. The pitch of the helix is 3.4 nm (a nanometre is one billionth of a metre, that is  $10^{-9}$  m) and there are roughly 10 bp in each



**Figure 5.2** Double stranded polynucleotide chain



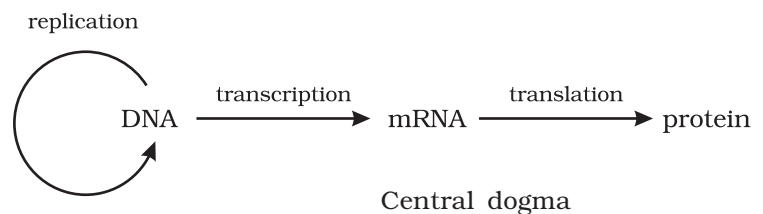
**Figure 5.3** DNA double helix

turn. Consequently, the distance between a bp in a helix is approximately 0.34 nm.

(v) The plane of one base pair stacks over the other in double helix. This, in addition to H-bonds, confers stability of the helical structure (Figure 5.3).

*Compare the structure of purines and pyrimidines. Can you find out why the distance between two polynucleotide chains in DNA remains almost constant?*

The proposition of a double helix structure for DNA and its simplicity in explaining the genetic implication became revolutionary. Very soon, Francis Crick proposed the Central dogma in molecular biology, which states that the genetic information flows from DNA→RNA→Protein.





In some viruses the flow of information is in reverse direction, that is, from RNA to DNA. *Can you suggest a simple name to the process?*

### 5.1.2 Packaging of DNA Helix

Taken the distance between two consecutive base pairs as 0.34 nm ( $0.34 \times 10^{-9}$  m), if the length of DNA double helix in a typical mammalian cell is calculated (simply by multiplying the total number of bp with distance between two consecutive bp, that is,  $6.6 \times 10^9$  bp  $\times$   $0.34 \times 10^{-9}$  m/bp), it comes out to be approximately 2.2 metres. A length that is far greater than the dimension of a typical nucleus (approximately  $10^{-6}$  m). How is such a long polymer packaged in a cell?

*If the length of E. coli DNA is 1.36 mm, can you calculate the number of base pairs in E.coli?*

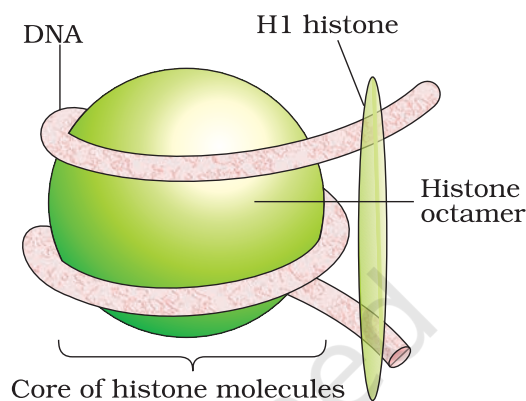
In prokaryotes, such as, *E. coli*, though they do not have a defined nucleus, the DNA is not scattered throughout the cell. DNA (being negatively charged) is held with some proteins (that have positive charges) in a region termed as 'nucleoid'. The DNA in nucleoid is organised in large loops held by proteins.

In eukaryotes, this organisation is much more complex. There is a set of positively charged, basic proteins called **histones**. A protein acquires charge depending upon the abundance of amino acids residues with charged side chains. Histones are rich in the basic amino acid residues lysine and arginine. Both the amino acid residues carry positive charges in their side chains. Histones are organised to form a unit of eight molecules called **histone octamer**.

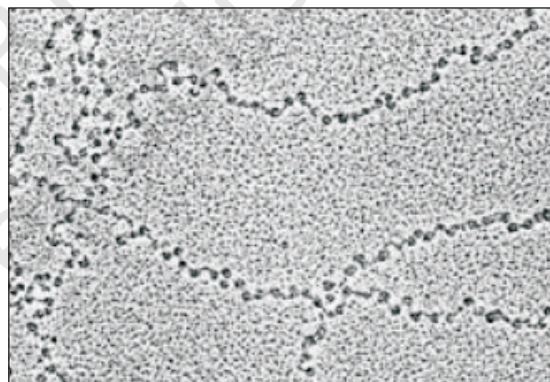
The negatively charged DNA is wrapped around the positively charged histone octamer to form a structure called **nucleosome** (Figure 5.4 a). A typical nucleosome contains 200 bp of DNA helix. Nucleosomes constitute the repeating unit of a structure in nucleus called **chromatin**, thread-like stained (coloured) bodies seen in nucleus. The nucleosomes in chromatin are seen as 'beads-on-string' structure when viewed under electron microscope (EM) (Figure 5.4 b).

*Theoretically, how many such beads (nucleosomes) do you imagine are present in a mammalian cell?*

The beads-on-string structure in chromatin is packaged to form chromatin fibers that are further coiled and condensed at metaphase stage of cell division to form chromosomes. The packaging of chromatin at higher level requires additional set of proteins that collectively are referred to as



**Figure 5.4a** Nucleosome



**Figure 5.4b** EM picture - 'Beads-on-String'



**Non-histone Chromosomal (NHC) proteins.** In a typical nucleus, some region of chromatin are loosely packed (and stains light) and are referred to as **euchromatin**. The chromatin that is more densely packed and stains dark are called as **Heterochromatin**. Euchromatin is said to be transcriptionally active chromatin, whereas heterochromatin is inactive.

## 5.2 THE SEARCH FOR GENETIC MATERIAL

Even though the discovery of nuclein by Meischer and the proposition for principles of inheritance by Mendel were almost at the same time, but that the DNA acts as a genetic material took long to be discovered and proven. By 1926, the quest to determine the mechanism for genetic inheritance had reached the molecular level. Previous discoveries by Gregor Mendel, Walter Sutton, Thomas Hunt Morgan and numerous other scientists had narrowed the search to the chromosomes located in the nucleus of most cells. But the question of what molecule was actually the genetic material, had not been answered.

### Transforming Principle

In 1928, Frederick Griffith, in a series of experiments with *Streptococcus pneumoniae* (bacterium responsible for pneumonia), witnessed a miraculous transformation in the bacteria. During the course of his experiment, a living organism (bacteria) had changed in physical form.

When *Streptococcus pneumoniae* (pneumococcus) bacteria are grown on a culture plate, some produce smooth shiny colonies (S) while others produce rough colonies (R). This is because the S strain bacteria have a mucous (polysaccharide) coat, while R strain does not. Mice infected with the S strain (virulent) die from pneumonia infection but mice infected with the R strain do not develop pneumonia.

S strain → Inject into mice → Mice die

R strain → Inject into mice → Mice live

Griffith was able to kill bacteria by heating them. He observed that heat-killed S strain bacteria injected into mice did not kill them. When he

S strain (heat-killed) → Inject into mice → Mice live

S strain (heat-killed)  
+  
R strain (live) → Inject into mice → Mice die





injected a mixture of heat-killed S and live R bacteria, the mice died. Moreover, he recovered living S bacteria from the dead mice.

He concluded that the R strain bacteria had somehow been **transformed** by the heat-killed S strain bacteria. Some 'transforming principle', transferred from the heat-killed S strain, had enabled the R strain to synthesise a smooth polysaccharide coat and become virulent. This must be due to the transfer of the genetic material. However, the biochemical nature of genetic material was not defined from his experiments.

### **Biochemical Characterisation of Transforming Principle**

Prior to the work of Oswald Avery, Colin MacLeod and Maclyn McCarty (1933-44), the genetic material was thought to be a protein. They worked to determine the biochemical nature of 'transforming principle' in Griffith's experiment.

They purified biochemicals (proteins, DNA, RNA, etc.) from the heat-killed S cells to see which ones could transform live R cells into S cells. They discovered that DNA alone from S bacteria caused R bacteria to become transformed.

They also discovered that protein-digesting enzymes (proteases) and RNA-digesting enzymes (RNases) did not affect transformation, so the transforming substance was not a protein or RNA. Digestion with DNase did inhibit transformation, suggesting that the DNA caused the transformation. They concluded that DNA is the hereditary material, but not all biologists were convinced.

*Can you think of any difference between DNAs and DNase?*

#### **5.2.1 The Genetic Material is DNA**

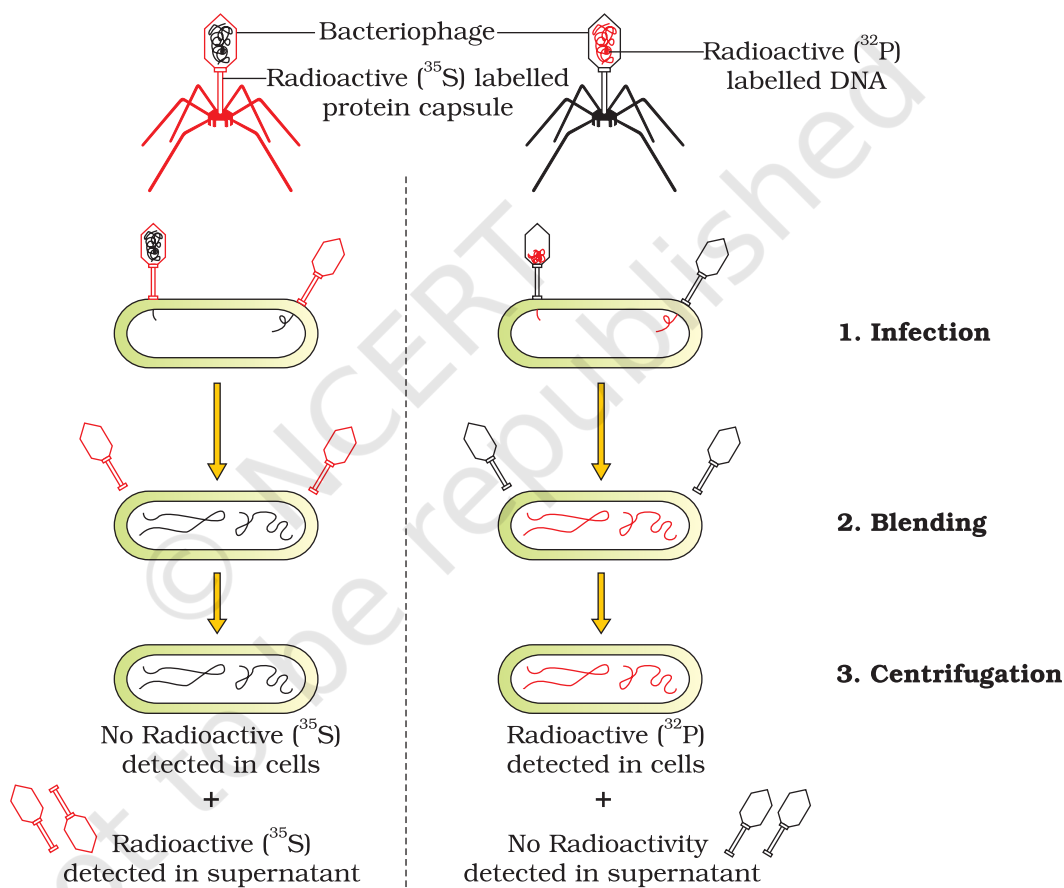
The unequivocal proof that DNA is the genetic material came from the experiments of Alfred Hershey and Martha Chase (1952). They worked with viruses that infect bacteria called bacteriophages.

The bacteriophage attaches to the bacteria and its genetic material then enters the bacterial cell. The bacterial cell treats the viral genetic material as if it was its own and subsequently manufactures more virus particles. Hershey and Chase worked to discover whether it was protein or DNA from the viruses that entered the bacteria.

They grew some viruses on a medium that contained radioactive phosphorus and some others on medium that contained radioactive sulfur. Viruses grown in the presence of radioactive phosphorus contained radioactive DNA but not radioactive protein because DNA contains phosphorus but protein does not. Similarly, viruses grown on radioactive sulfur contained radioactive protein but not radioactive DNA because DNA does not contain sulfur.

Radioactive phages were allowed to attach to *E. coli* bacteria. Then, as the infection proceeded, the viral coats were removed from the bacteria by agitating them in a blender. The virus particles were separated from the bacteria by spinning them in a centrifuge.

Bacteria which was infected with viruses that had radioactive DNA were radioactive, indicating that DNA was the material that passed from the virus to the bacteria. Bacteria that were infected with viruses that had radioactive proteins were not radioactive. This indicates that proteins did not enter the bacteria from the viruses. DNA is therefore the genetic material that is passed from virus to bacteria (Figure 5.5).



**Figure 5.5** The Hershey-Chase experiment

### 5.2.2 Properties of Genetic Material (DNA versus RNA)

From the foregoing discussion, it is clear that the debate between proteins versus DNA as the genetic material was unequivocally resolved from Hershey-Chase experiment. It became an established fact that it is DNA that acts as genetic material. However, it subsequently became clear that



in some viruses, RNA is the genetic material (for example, Tobacco Mosaic viruses,  $\phi$ B bacteriophage, etc.). Answer to some of the questions such as, why DNA is the predominant genetic material, whereas RNA performs dynamic functions of messenger and adapter has to be found from the differences between chemical structures of the two nucleic acid molecules.

*Can you recall the two chemical differences between DNA and RNA?*

A molecule that can act as a genetic material must fulfill the following criteria:

- (i) It should be able to generate its replica (Replication).
- (ii) It should be stable chemically and structurally.
- (iii) It should provide the scope for slow changes (mutation) that are required for evolution.
- (iv) It should be able to express itself in the form of 'Mendelian Characters'.

If one examines each requirement one by one, because of rule of base pairing and complementarity, both the nucleic acids (DNA and RNA) have the ability to direct their duplications. The other molecules in the living system, such as proteins fail to fulfill first criteria itself.

The genetic material should be stable enough not to change with different stages of life cycle, age or with change in physiology of the organism. Stability as one of the properties of genetic material was very evident in Griffith's 'transforming principle' itself that heat, which killed the bacteria, at least did not destroy some of the properties of genetic material. This now can easily be explained in light of the DNA that the two strands being complementary if separated by heating come together, when appropriate conditions are provided. Further, 2'-OH group present at every nucleotide in RNA is a reactive group and makes RNA labile and easily degradable. RNA is also now known to be catalytic, hence reactive. Therefore, DNA chemically is less reactive and structurally more stable when compared to RNA. Therefore, among the two nucleic acids, the DNA is a better genetic material.

In fact, the presence of thymine at the place of uracil also confers additional stability to DNA. (Detailed discussion about this requires understanding of the process of repair in DNA, and you will study these processes in higher classes.)

Both DNA and RNA are able to mutate. In fact, RNA being unstable, mutate at a faster rate. Consequently, viruses having RNA genome and having shorter life span mutate and evolve faster.

RNA can directly code for the synthesis of proteins, hence can easily express the characters. DNA, however, is dependent on RNA for synthesis of proteins. The protein synthesising machinery has evolved around RNA. The above discussion indicate that both RNA and DNA can function as

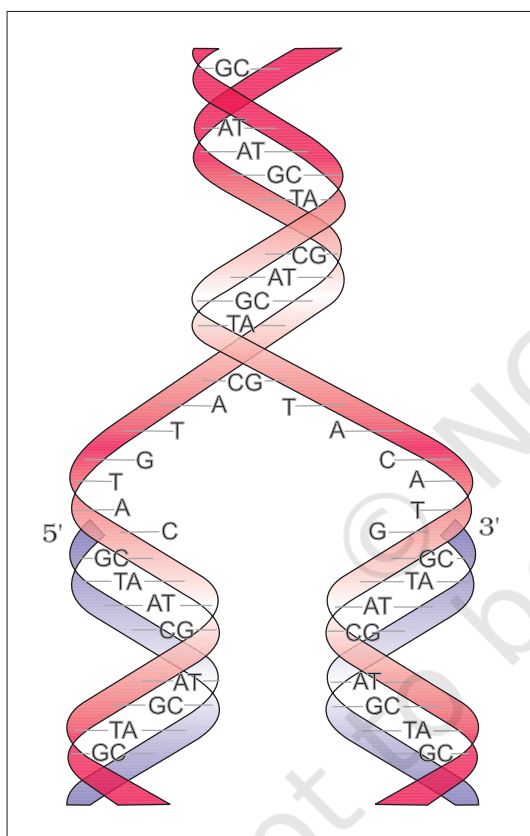
genetic material, but DNA being more stable is preferred for storage of genetic information. For the transmission of genetic information, RNA is better.

### 5.3 RNA WORLD

From foregoing discussion, an immediate question becomes evident – which is the first genetic material? It shall be discussed in detail in the chapter on chemical evolution, but briefly, we shall highlight some of the facts and points.

RNA was the first genetic material. There is now enough evidence to suggest that essential life processes (such as metabolism, translation,

splicing, etc.), evolved around RNA. RNA used to act as a genetic material as well as a catalyst (there are some important biochemical reactions in living systems that are catalysed by RNA catalysts and not by protein enzymes). But, RNA being a catalyst was reactive and hence unstable. Therefore, DNA has evolved from RNA with chemical modifications that make it more stable. DNA being double stranded and having complementary strand further resists changes by evolving a process of repair.



**Figure 5.6** Watson-Crick model for semiconservative DNA replication

### 5.4 REPLICATION

While proposing the double helical structure for DNA, Watson and Crick had immediately proposed a scheme for replication of DNA. To quote their original statement that is as follows:

“It has not escaped our notice that the specific pairing we have postulated immediately suggests a possible copying mechanism for the genetic material” (Watson and Crick, 1953).

The scheme suggested that the two strands would separate and act as a template for the synthesis of new complementary strands. After the completion of replication, each DNA molecule would have one parental and one newly synthesised strand. This scheme was termed as **semiconservative** DNA replication (Figure 5.6).

#### 5.4.1 The Experimental Proof

It is now proven that DNA replicates semiconservatively. It was shown first in *Escherichia coli* and subsequently in higher organisms, such as plants

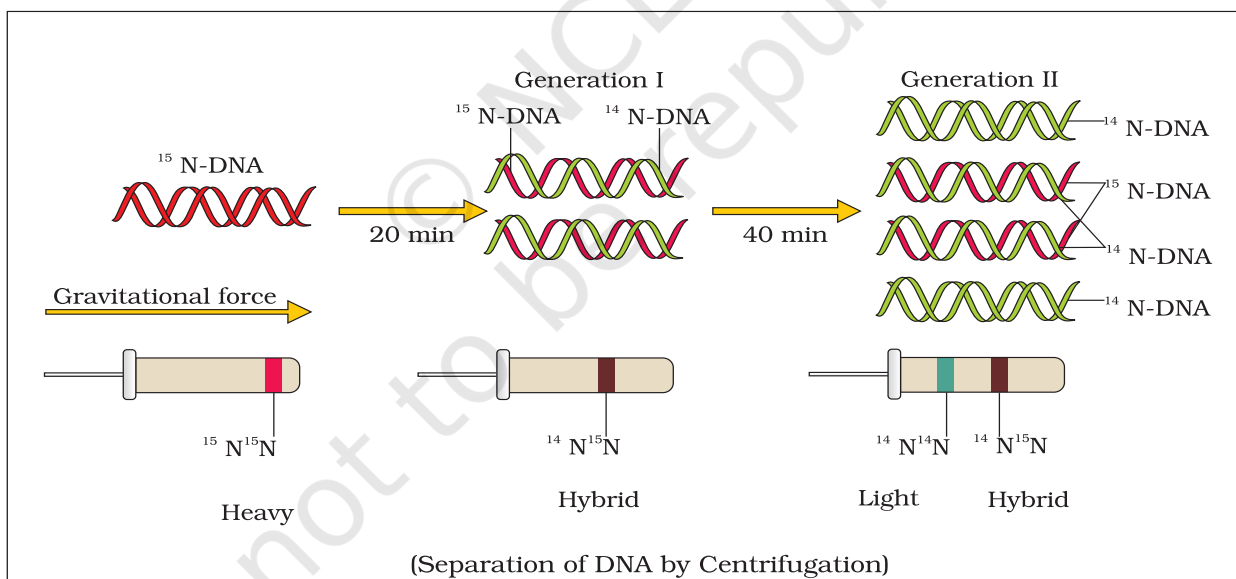


and human cells. Matthew Meselson and Franklin Stahl performed the following experiment in 1958:

- (i) They grew *E. coli* in a medium containing  $^{15}\text{NH}_4\text{Cl}$  ( $^{15}\text{N}$  is the heavy isotope of nitrogen) as the only nitrogen source for many generations. The result was that  $^{15}\text{N}$  was incorporated into newly synthesised DNA (as well as other nitrogen containing compounds). This heavy DNA molecule could be distinguished from the normal DNA by centrifugation in a cesium chloride (CsCl) density gradient (Please note that  $^{15}\text{N}$  is not a radioactive isotope, and it can be separated from  $^{14}\text{N}$  only based on densities).
- (ii) Then they transferred the cells into a medium with normal  $^{14}\text{NH}_4\text{Cl}$  and took samples at various definite time intervals as the cells multiplied, and extracted the DNA that remained as double-stranded helices. The various samples were separated independently on CsCl gradients to measure the densities of DNA (Figure 5.7).

*Can you recall what centrifugal force is, and think why a molecule with higher mass/density would sediment faster?*

The results are shown in Figure 5.7.



**Figure 5.7** Meselson and Stahl's Experiment

- (iii) Thus, the DNA that was extracted from the culture one generation after the transfer from  $^{15}\text{N}$  to  $^{14}\text{N}$  medium [that is after 20 minutes; *E. coli* divides in 20 minutes] had a hybrid or intermediate density. DNA extracted from the culture after another generation [that is after 40 minutes, II generation] was

composed of equal amounts of this hybrid DNA and of 'light' DNA.

*If E. coli was allowed to grow for 80 minutes then what would be the proportions of light and hybrid densities DNA molecule?*

Very similar experiments involving use of radioactive thymidine to detect distribution of newly synthesised DNA in the chromosomes was performed on *Vicia faba* (faba beans) by Taylor and colleagues in 1958. The experiments proved that the DNA in chromosomes also replicate semiconservatively.

### 5.4.2 The Machinery and the Enzymes

In living cells, such as *E. coli*, the process of replication requires a set of catalysts (enzymes). The main enzyme is referred to as DNA-dependent **DNA polymerase**, since it uses a DNA template to catalyse the polymerisation of deoxynucleotides. These enzymes are highly efficient enzymes as they have to catalyse polymerisation of a large number of nucleotides in a very short time. *E. coli* that has only  $4.6 \times 10^6$  bp (compare it with human whose diploid content is  $6.6 \times 10^9$  bp), completes the process of replication within 18 minutes; that means the average rate of polymerisation has to be approximately 2000 bp per second. Not only do these polymerases have to be fast, but they also have to catalyse the reaction with high degree of accuracy. Any mistake during replication would result into mutations. Furthermore, energetically replication is a very expensive process. Deoxyribonucleoside triphosphates serve dual purposes. In addition to acting as substrates, they provide energy for polymerisation reaction (the two terminal phosphates in a deoxynucleoside triphosphates are high-energy phosphates, same as in case of ATP).

In addition to DNA-dependent DNA polymerases, many additional enzymes are required to complete the process of replication with high degree of accuracy. For long DNA molecules, since the two strands of DNA cannot be separated in its entire length (due to very high energy requirement), the replication occur within a small opening of the DNA helix, referred to as **replication fork**. The DNA-dependent DNA polymerases catalyse polymerisation only in one direction, that is  $5' \rightarrow 3'$ . This creates some additional complications at the replicating fork. Consequently, on one strand (the template with polarity  $3' \rightarrow 5'$ ), the replication is **continuous**, while on the other (the template with polarity  $5' \rightarrow 3'$ ), it is **discontinuous**. The discontinuously synthesised fragments are later joined by the enzyme **DNA ligase** (Figure 5.8).

The DNA polymerases on their own cannot initiate the process of replication. Also the replication does not initiate randomly at any place in DNA. There is a definite region in *E. coli* DNA where the replication originates. Such regions are termed as **origin of replication**. It is



because of the requirement of the origin of replication that a piece of DNA is needed to be propagated during recombinant DNA procedures, requires a vector. The vectors provide the origin of replication.

Further, not every detail of replication is understood well. In eukaryotes, the replication of DNA takes place at S-phase of the cell-cycle. The replication of DNA and cell division cycle should be highly coordinated. A failure in cell division after DNA replication results into polyploidy (a chromosomal anomaly). You will learn the detailed nature of origin and the processes occurring at this site, in higher classes.

## 5.5 TRANSCRIPTION

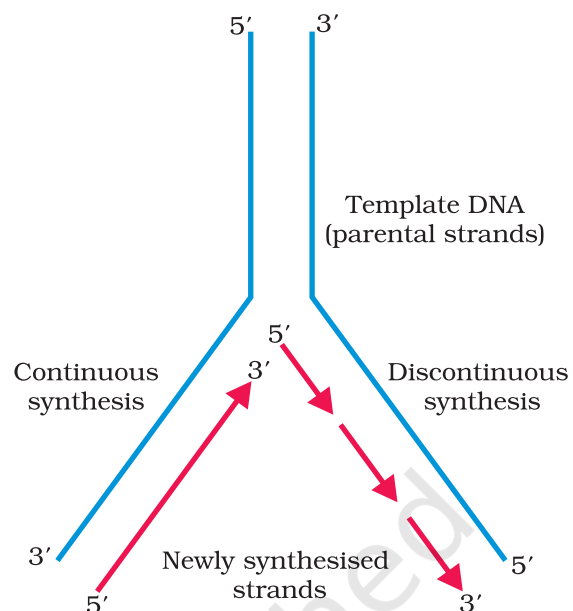
The process of copying genetic information from one strand of the DNA into RNA is termed as **transcription**. Here also, the principle of complementarity governs the process of transcription, except the adenosine complements now forms base pair with uracil instead of thymine. However, unlike in the process of replication, which once set in, the total DNA of an organism gets duplicated, in transcription only a segment of DNA and only one of the strands is copied into RNA. This necessitates defining the boundaries that would demarcate the region and the strand of DNA that would be transcribed.

Why both the strands are not copied during transcription has the simple answer. First, if both strands act as a template, they would code for RNA molecule with different sequences (Remember complementarity does not mean identical), and in turn, if they code for proteins, the sequence of amino acids in the proteins would be different. Hence, one segment of the DNA would be coding for different proteins, and this would complicate the genetic information transfer machinery. Second, the two RNA molecules if produced simultaneously would be complementary to each other, hence would form a double stranded RNA. This would prevent RNA from being translated into protein and the exercise of transcription would become a futile one.

### 5.5.1 Transcription Unit

A transcription unit in DNA is defined primarily by the three regions in the DNA:

- (i) A Promoter
- (ii) The Structural gene
- (iii) A Terminator



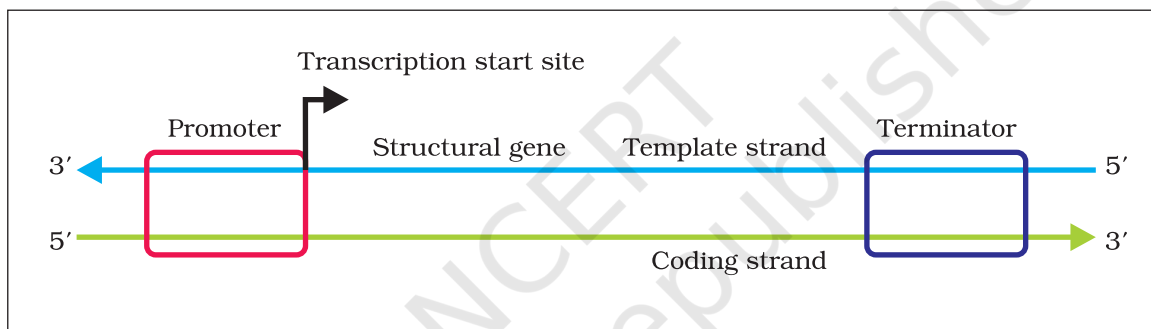
**Figure 5.8** Replicating Fork

There is a convention in defining the two strands of the DNA in the structural gene of a transcription unit. Since the two strands have opposite polarity and the **DNA-dependent RNA polymerase** also catalyse the polymerisation in only one direction, that is, 5'–3', the strand that has the polarity 3'–5' acts as a template, and is also referred to as **template strand**. The other strand which has the polarity (5'–3') and the sequence same as RNA (except thymine at the place of uracil), is displaced during transcription. Strangely, this strand (which does not code for anything) is referred to as **coding strand**. All the reference point while defining a transcription unit is made with coding strand. To explain the point, a hypothetical sequence from a transcription unit is represented below:

3'-ATGCATGCATGCATGCATGC-5' Template Strand

5'-TACGTACGTACGTACGTACG-3' Coding Strand

*Can you now write the sequence of RNA transcribed from the above DNA?*



**Figure 5.9** Schematic structure of a transcription unit

The **promoter** and **terminator** flank the **structural gene** in a transcription unit. The promoter is said to be located towards 5'-end (upstream) of the structural gene (the reference is made with respect to the polarity of coding strand). It is a DNA sequence that provides binding site for RNA polymerase, and it is the presence of a promoter in a transcription unit that also defines the template and coding strands. By switching its position with terminator, the definition of coding and template strands could be reversed. The terminator is located towards 3'-end (downstream) of the coding strand and it usually defines the end of the process of transcription (Figure 5.9). There are additional regulatory sequences that may be present further upstream or downstream to the promoter. Some of the properties of these sequences shall be discussed while dealing with regulation of gene expression.

### 5.5.2 Transcription Unit and the Gene

A gene is defined as the functional unit of inheritance. Though there is no ambiguity that the genes are located on the DNA, it is difficult to literally



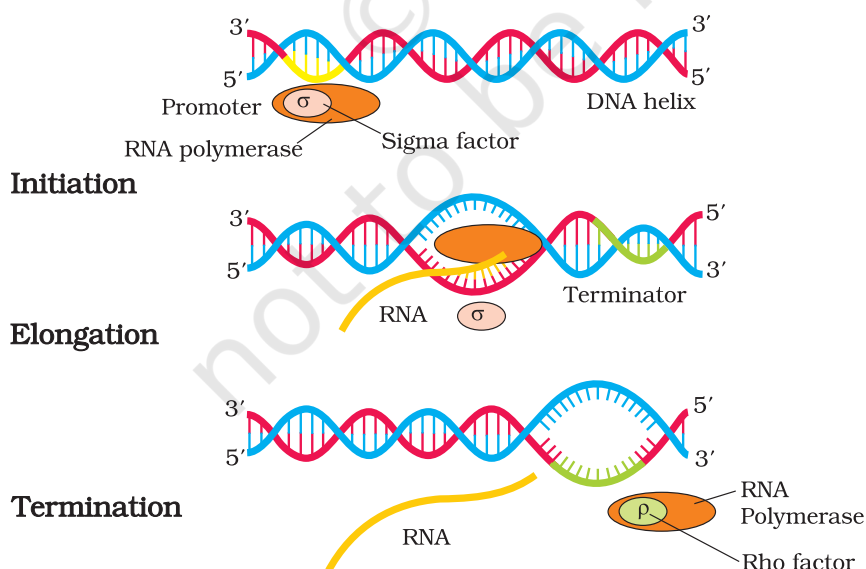


define a gene in terms of DNA sequence. The DNA sequence coding for tRNA or rRNA molecule also define a gene. However by defining a **cistron** as a segment of DNA coding for a polypeptide, the structural gene in a transcription unit could be said as **monocistronic** (mostly in eukaryotes) or **polycistronic** (mostly in bacteria or prokaryotes). In eukaryotes, the monocistronic structural genes have interrupted coding sequences – the genes in eukaryotes are split. The coding sequences or expressed sequences are defined as **exons**. Exons are said to be those sequence that appear in mature or processed RNA. The exons are interrupted by **introns**. Introns or intervening sequences do not appear in mature or processed RNA. The split-gene arrangement further complicates the definition of a gene in terms of a DNA segment.

Inheritance of a character is also affected by promoter and regulatory sequences of a structural gene. Hence, sometime the regulatory sequences are loosely defined as regulatory genes, even though these sequences do not code for any RNA or protein.

### 5.5.3 Types of RNA and the process of Transcription

In bacteria, there are three major types of RNAs: mRNA (messenger RNA), tRNA (transfer RNA), and rRNA (ribosomal RNA). All three RNAs are needed to synthesise a protein in a cell. The mRNA provides the template, tRNA brings aminoacids and reads the genetic code, and rRNAs play structural and catalytic role during translation. There is single DNA-dependent RNA polymerase that catalyses transcription of all types of RNA in bacteria. RNA polymerase binds to promoter and initiates transcription (**Initiation**). It uses nucleoside triphosphates as substrate



**Figure 5.10** Process of Transcription in Bacteria

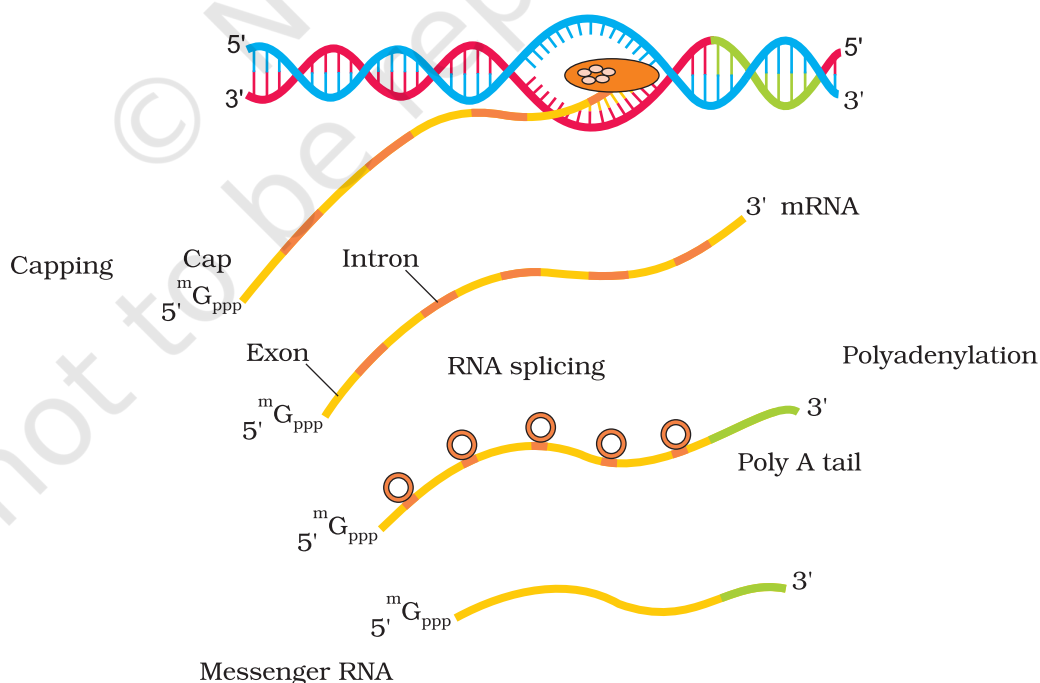
and polymerises in a template depended fashion following the rule of complementarity. It somehow also facilitates opening of the helix and continues elongation. Only a short stretch of RNA remains bound to the enzyme. Once the polymerases reaches the terminator region, the nascent RNA falls off, so also the RNA polymerase. This results in **termination** of transcription.

An intriguing question is that how is the RNA polymerases able to catalyse all the three steps, which are initiation, elongation and termination. The RNA polymerase is only capable of catalysing the process of elongation. It associates transiently with **initiation-factor** ( $\sigma$ ) and **termination-factor** ( $\rho$ ) to initiate and terminate the transcription, respectively. Association with these factors alter the specificity of the RNA polymerase to either initiate or terminate (Figure 5.10).

In bacteria, since the mRNA does not require any processing to become active, and also since transcription and translation take place in the same compartment (there is no separation of cytosol and nucleus in bacteria), many times the translation can begin much before the mRNA is fully transcribed. Consequently, the transcription and translation can be coupled in bacteria.

In eukaryotes, there are two additional complexities –

- (i) There are at least three RNA polymerases in the nucleus (in addition to the RNA polymerase found in the organelles). There is a clear cut division of labour. The RNA polymerase I transcribes **rRNAs**



**Figure 5.11** Process of Transcription in Eukaryotes



(28S, 18S, and 5.8S), whereas the RNA polymerase III is responsible for transcription of **tRNA**, **5srRNA**, and **snRNAs (small nuclear RNAs)**. The RNA polymerase II transcribes precursor of mRNA, the **heterogeneous nuclear RNA (hnRNA)**.

- (ii) The second complexity is that the primary transcripts contain both the exons and the introns and are non-functional. Hence, it is subjected to a process called **splicing** where the introns are removed and exons are joined in a defined order. hnRNA undergoes additional processing called as capping and tailing. In **capping** an unusual nucleotide (methyl guanosine triphosphate) is added to the 5'-end of hnRNA. In **tailing**, adenylate residues (200-300) are added at 3'-end in a template independent manner. It is the fully processed hnRNA, now called mRNA, that is transported out of the nucleus for translation (Figure 5.11).

The significance of such complexities is now beginning to be understood. The split-gene arrangements represent probably an ancient feature of the genome. The presence of introns is reminiscent of antiquity, and the process of splicing represents the dominance of **RNA-world**. In recent times, the understanding of RNA and RNA-dependent processes in the living system have assumed more importance.

## 5.6 GENETIC CODE

During replication and transcription a nucleic acid was copied to form another nucleic acid. Hence, these processes are easy to conceptualise on the basis of complementarity. The process of translation requires transfer of genetic information from a polymer of nucleotides to synthesise a polymer of amino acids. Neither does any complementarity exist between nucleotides and amino acids, nor could any be drawn theoretically. There existed ample evidences, though, to support the notion that change in nucleic acids (genetic material) were responsible for change in amino acids in proteins. This led to the proposition of a genetic code that could direct the sequence of amino acids during synthesis of proteins.

If determining the biochemical nature of genetic material and the structure of DNA was very exciting, the proposition and deciphering of genetic code were most challenging. In a very true sense, it required involvement of scientists from several disciplines – physicists, organic chemists, biochemists and geneticists. It was George Gamow, a physicist, who argued that since there are only 4 bases and if they have to code for 20 amino acids, the code should constitute a combination of bases. He suggested that in order to code for all the 20 amino acids, the code should be made up of three nucleotides. This was a very bold proposition, because a permutation combination of  $4^3$  ( $4 \times 4 \times 4$ ) would generate 64 codons; generating many more codons than required.

Providing proof that the codon was a triplet, was a more daunting task. The chemical method developed by Har Gobind Khorana was

instrumental in synthesising RNA molecules with defined combinations of bases (homopolymers and copolymers). Marshall Nirenberg's cell-free system for protein synthesis finally helped the code to be deciphered. Severo Ochoa enzyme (polynucleotide phosphorylase) was also helpful in polymerising RNA with defined sequences in a template independent manner (enzymatic synthesis of RNA). Finally a checker-board for genetic code was prepared which is given in Table 5.1.

**Table 5.1: The Codons for the Various Amino Acids**

First position	Second position				Third position
	U	C	A	G	
U	UUU Phe	UCU Ser	UAU Tyr	UGU Cys	U
	UUC Phe	UCC Ser	UAC Tyr	UGC Cys	C
	UUA Leu	UCA Ser	UAA Stop	UGA Stop	A
	UUG Leu	UCG Ser	UAG Stop	UGG Trp	G
C	CUU Leu	CCU Pro	CAU His	CGU Arg	U
	CUC Leu	CCC Pro	CAC His	CGC Arg	C
	CUA Leu	CCA Pro	CAA Gln	CGA Arg	A
	CUG Leu	CCG Pro	CAG Gln	CGG Arg	G
A	AUU Ile	ACU Thr	AAU Asn	AGU Ser	U
	AUC Ile	ACC Thr	AAC Asn	AGC Ser	C
	AUA Ile	ACA Thr	AAA Lys	AGA Arg	A
	AUG Met	ACG Thr	AAG Lys	AGG Arg	G
G	GUU Val	GCU Ala	GAU Asp	GGU Gly	U
	GUC Val	GCC Ala	GAC Asp	GGC Gly	C
	GUA Val	GCA Ala	GAA Glu	GGA Gly	A
	GUG Val	GCG Ala	GAG Glu	GGG Gly	G

The salient features of genetic code are as follows:

- The codon is triplet. 61 codons code for amino acids and 3 codons do not code for any amino acids, hence they function as stop codons.
- Some amino acids are coded by more than one codon, hence the code is **degenerate**.
- The codon is read in mRNA in a contiguous fashion. There are no punctuations.
- The code is nearly **universal**: for example, from bacteria to human UUU would code for Phenylalanine (phe). Some exceptions to this rule have been found in mitochondrial codons, and in some protozoans.
- AUG has dual functions. It codes for Methionine (met), and it also act as **initiator** codon.
- UAA, UAG, UGA are stop terminator codons.

*If following is the sequence of nucleotides in mRNA, predict the sequence of amino acid coded by it (take help of the checkerboard):*

*-AUG UUU UUC UUC UUU UUU UUC-*



Now try the opposite. Following is the sequence of amino acids coded by an mRNA. Predict the nucleotide sequence in the RNA:

*Met-Phe-Phe-Phe-Phe-Phe-Phe*

Do you face any difficulty in predicting the opposite?

Can you now correlate which two properties of genetic code you have learnt?

### 5.6.1 Mutations and Genetic Code

The relationships between genes and DNA are best understood by mutation studies. You have studied about mutation and its effect in Chapter 4. Effects of large deletions and rearrangements in a segment of DNA are easy to comprehend. It may result in loss or gain of a gene and so a function. The effect of point mutations will be explained here. A classical example of point mutation is a change of single base pair in the gene for beta globin chain that results in the change of amino acid residue glutamate to valine. It results into a diseased condition called as **sickle cell anemia**. Effect of point mutations that inserts or deletes a base in structural gene can be better understood by following simple example.

Consider a statement that is made up of the following words each having three letters like genetic code.

**RAM HAS RED CAP**

If we insert a letter B in between HAS and RED and rearrange the statement, it would read as follows:

**RAM HAS BRE DCA P**

Similarly, if we now insert two letters at the same place, say BI. Now it would read,

**RAM HAS BIR EDC AP**

Now we insert three letters together, say BIG, the statement would read

**RAM HAS BIG RED CAP**

The same exercise can be repeated, by deleting the letters R, E and D, one by one and rearranging the statement to make a triplet word.

**RAM HAS EDC AP**

**RAM HAS DCA P**

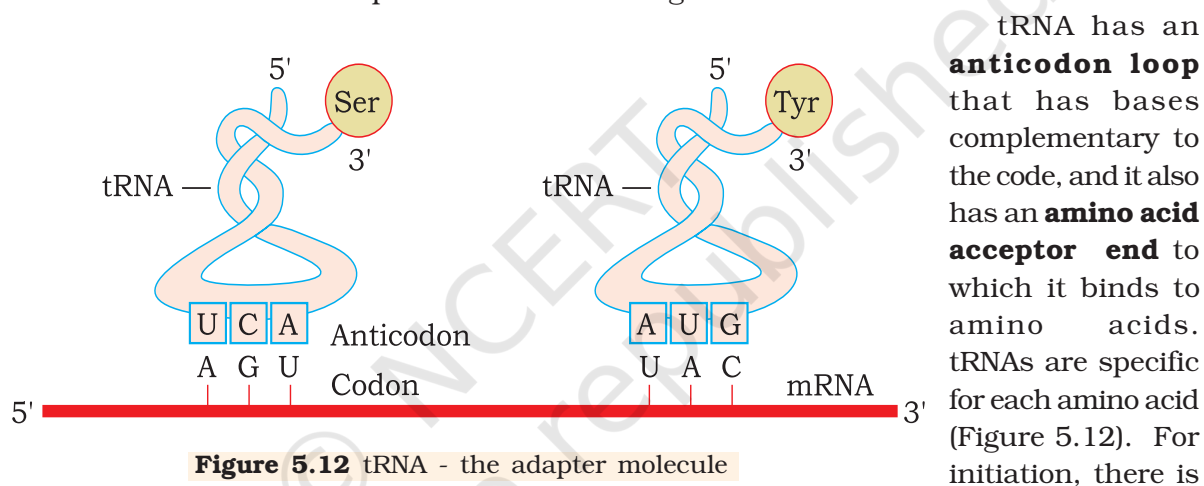
**RAM HAS CAP**

The conclusion from the above exercise is very obvious. Insertion or deletion of one or two bases changes the reading frame from the point of insertion or deletion. However, such mutations are referred to as

**frameshift insertion or deletion mutations.** Insertion or deletion of three or its multiple bases insert or delete in one or multiple codon hence one or multiple amino acids, and reading frame remains unaltered from that point onwards.

### 5.6.2 tRNA- the Adapter Molecule

From the very beginning of the proposition of code, it was clear to Francis Crick that there has to be a mechanism to read the code and also to link it to the amino acids, because amino acids have no structural specialities to read the code uniquely. He postulated the presence of an adapter molecule that would on one hand read the code and on other hand would bind to specific amino acids. The tRNA, then called sRNA (soluble RNA), was known before the genetic code was postulated. However, its role as an adapter molecule was assigned much later.



**Figure 5.12** tRNA - the adapter molecule

another specific tRNA that is referred to as **initiator tRNA**. There are no tRNAs for stop codons. In figure 5.12, the secondary structure of tRNA has been depicted that looks like a clover-leaf. In actual structure, the tRNA is a compact molecule which looks like inverted L.

## 5.7 TRANSLATION

**Translation** refers to the process of polymerisation of amino acids to form a polypeptide (Figure 5.13). The order and sequence of amino acids are defined by the sequence of bases in the mRNA. The amino acids are joined by a bond which is known as a peptide bond. Formation of a peptide bond requires energy. Therefore, in the first phase itself amino acids are activated in the presence of ATP and linked to their cognate tRNA—a process commonly called as **charging of tRNA** or **aminoacylation of tRNA** to be more specific. If two such charged tRNAs are brought close enough, the formation of peptide bond between them

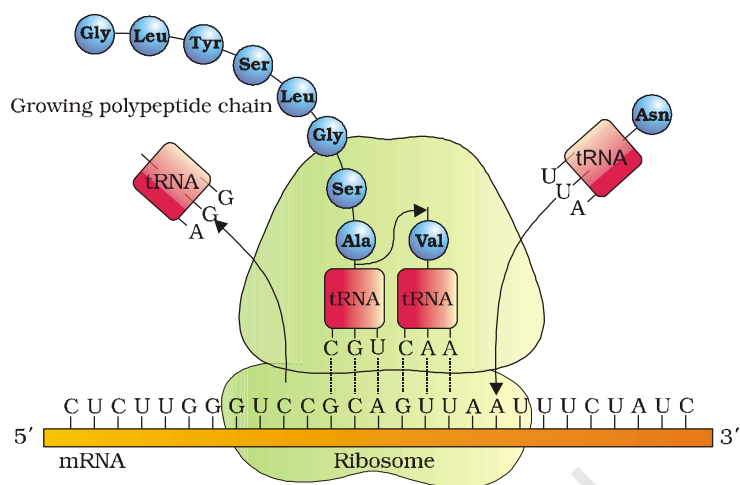


would be favoured energetically. The presence of a catalyst would enhance the rate of peptide bond formation.

The cellular factory responsible for synthesising proteins is the ribosome. The ribosome consists of structural RNAs and about 80 different proteins. In its inactive state, it exists as two subunits; a large subunit and a small subunit. When the small subunit encounters an mRNA, the process of translation of the mRNA to protein begins. There are two sites in the large subunit, for subsequent amino acids to bind to and thus, be close enough to each other for the formation of a peptide bond. The ribosome also acts as a catalyst (23S rRNA in bacteria is the enzyme- ribozyme) for the formation of peptide bond.

A translational unit in mRNA is the sequence of RNA that is flanked by the start codon (AUG) and the stop codon and codes for a polypeptide. An mRNA also has some additional sequences that are not translated and are referred as **untranslated regions (UTR)**. The UTRs are present at both 5'-end (before start codon) and at 3'-end (after stop codon). They are required for efficient translation process.

For initiation, the ribosome binds to the mRNA at the start codon (AUG) that is recognised only by the initiator tRNA. The ribosome proceeds to the elongation phase of protein synthesis. During this stage, complexes composed of an amino acid linked to tRNA, sequentially bind to the appropriate codon in mRNA by forming complementary base pairs with the tRNA anticodon. The ribosome moves from codon to codon along the mRNA. Amino acids are added one by one, translated into Polypeptide sequences dictated by DNA and represented by mRNA. At the end, a **release factor** binds to the stop codon, terminating translation and releasing the complete polypeptide from the ribosome.



**Figure 5.13** Translation

## 5.8 REGULATION OF GENE EXPRESSION

**Regulation** of gene expression refers to a very broad term that may occur at various levels. Considering that gene expression results in the formation of a polypeptide, it can be regulated at several levels. In eukaryotes, the regulation could be exerted at

- (i) transcriptional level (formation of primary transcript),
- (ii) processing level (regulation of splicing),
- (iii) transport of mRNA from nucleus to the cytoplasm,
- (iv) translational level.



The genes in a cell are expressed to perform a particular function or a set of functions. For example, if an enzyme called beta-galactosidase is synthesised by *E. coli*, it is used to catalyse the hydrolysis of a disaccharide, lactose into galactose and glucose; the bacteria use them as a source of energy. Hence, if the bacteria do not have lactose around them to be utilised for energy source, they would no longer require the synthesis of the enzyme beta-galactosidase. Therefore, in simple terms, it is the metabolic, physiological or environmental conditions that regulate the expression of genes. The development and differentiation of embryo into adult organisms are also a result of the coordinated regulation of expression of several sets of genes.

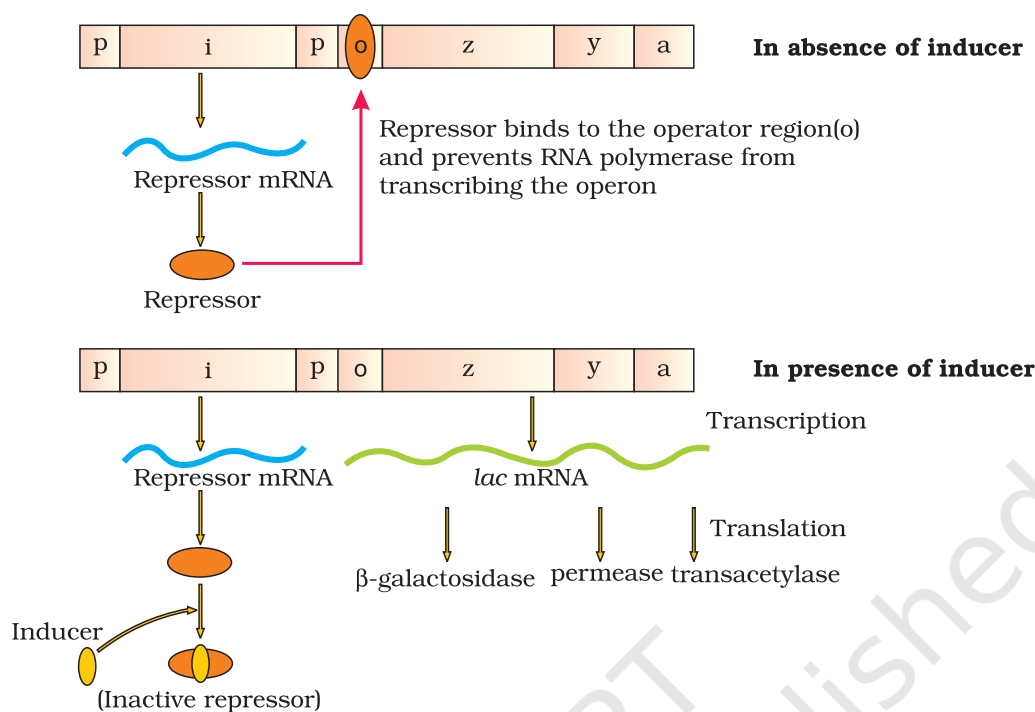
In prokaryotes, control of the rate of transcriptional initiation is the predominant site for control of gene expression. In a transcription unit, the activity of RNA polymerase at a given promoter is in turn regulated by interaction with accessory proteins, which affect its ability to recognise start sites. These regulatory proteins can act both positively (activators) and negatively (repressors). The accessibility of promoter regions of prokaryotic DNA is in many cases regulated by the interaction of proteins with sequences termed **operators**. The operator region is adjacent to the promoter elements in most operons and in most cases the sequences of the operator bind a repressor protein. Each operon has its specific operator and specific repressor. For example, *lac* operator is present only in the *lac* operon and it interacts specifically with *lac* repressor only.

### 5.8.1 The *Lac* operon

The elucidation of the *lac* operon was also a result of a close association between a geneticist, Francois Jacob and a biochemist, Jacques Monod. They were the first to elucidate a transcriptionally regulated system. In *lac* operon (here *lac* refers to lactose), a polycistronic structural gene is regulated by a common promoter and regulatory genes. Such arrangement is very common in bacteria and is referred to as **operon**. To name few such examples, *lac* operon, *trp* operon, *ara* operon, *his* operon, *val* operon, etc.

The *lac* operon consists of one regulatory gene (the *i* gene – here the term *i* does not refer to inducer, rather it is derived from the word inhibitor) and three structural genes (*z*, *y*, and *a*). The *i* gene codes for the repressor of the *lac* operon. The *z* gene codes for beta-galactosidase ( $\beta$ -gal), which is primarily responsible for the hydrolysis of the disaccharide, lactose into its monomeric units, galactose and glucose. The *y* gene codes for permease, which increases permeability of the cell to  $\beta$ -galactosides. The *a* gene encodes a transacetylase. Hence, all the three gene products in *lac* operon are required for metabolism of lactose. In most other operons as well, the genes present in the operon are needed together to function in the same or related metabolic pathway (Figure 5.14).





**Figure 5.14** The *lac* Operon

Lactose is the substrate for the enzyme beta-galactosidase and it regulates switching on and off of the operon. Hence, it is termed as **inducer**. In the absence of a preferred carbon source such as glucose, if lactose is provided in the growth medium of the bacteria, the lactose is transported into the cells through the action of permease (Remember, a very low level of expression of *lac* operon has to be present in the cell all the time, otherwise lactose cannot enter the cells). The lactose then induces the operon in the following manner.

The repressor of the operon is synthesised (all-the-time – constitutively) from the *i* gene. The repressor protein binds to the operator region of the operon and prevents RNA polymerase from transcribing the operon. In the presence of an inducer, such as lactose or allolactose, the repressor is inactivated by interaction with the inducer. This allows RNA polymerase access to the promoter and transcription proceeds (Figure 5.14). Essentially, regulation of *lac* operon can also be visualised as regulation of enzyme synthesis by its substrate.

*Remember, glucose or galactose cannot act as inducers for lac operon. Can you think for how long the lac operon would be expressed in the presence of lactose?*

Regulation of *lac* operon by repressor is referred to as **negative regulation**. *Lac* operon is under control of positive regulation as well, but it is beyond the scope of discussion at this level.

## 5.9 HUMAN GENOME PROJECT

In the preceding sections you have learnt that it is the sequence of bases in DNA that determines the genetic information of a given organism. In other words, genetic make-up of an organism or an individual lies in the DNA sequences. If two individuals differ, then their DNA sequences should also be different, at least at some places. These assumptions led to the quest of finding out the complete DNA sequence of human genome. With the establishment of genetic engineering techniques where it was possible to isolate and clone any piece of DNA and availability of simple and fast techniques for determining DNA sequences, a very ambitious project of sequencing human genome was launched in the year 1990.

**Human Genome Project** (HGP) was called a mega project. You can imagine the magnitude and the requirements for the project if we simply define the aims of the project as follows:

Human genome is said to have approximately  $3 \times 10^9$  bp, and if the cost of sequencing required is US \$ 3 per bp (the estimated cost in the beginning), the total estimated cost of the project would be approximately 9 billion US dollars. Further, if the obtained sequences were to be stored in typed form in books, and if each page of the book contained 1000 letters and each book contained 1000 pages, then 3300 such books would be required to store the information of DNA sequence from a single human cell. The enormous amount of data expected to be generated also necessitated the use of high speed computational devices for data storage and retrieval, and analysis. HGP was closely associated with the rapid development of a new area in biology called **Bioinformatics**.

### Goals of HGP

Some of the important goals of HGP were as follows:

- (i) Identify all the approximately 20,000-25,000 genes in human DNA;
- (ii) Determine the sequences of the 3 billion chemical base pairs that make up human DNA;
- (iii) Store this information in databases;
- (iv) Improve tools for data analysis;
- (v) Transfer related technologies to other sectors, such as industries;
- (vi) Address the ethical, legal, and social issues (ELSI) that may arise from the project.

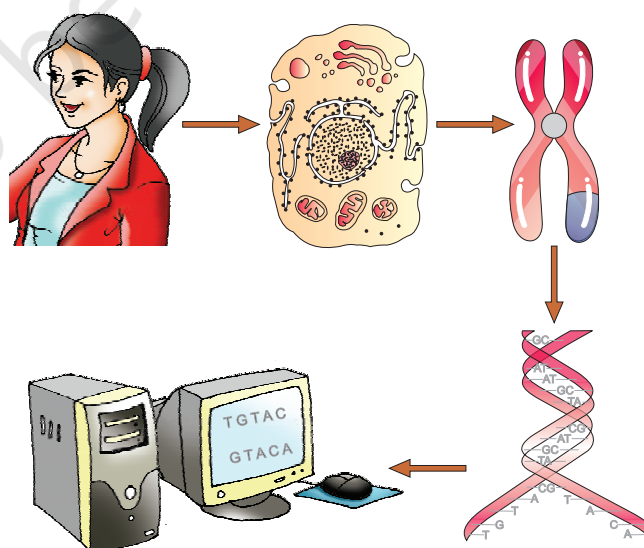
The Human Genome Project was a 13-year project coordinated by the U.S. Department of Energy and the National Institute of Health. During the early years of the HGP, the Wellcome Trust (U.K.) became a major partner; additional contributions came from Japan, France, Germany, China and others. The project was completed in 2003. Knowledge about the effects of DNA variations among individuals can lead to revolutionary new ways to diagnose, treat and someday prevent the thousands of



disorders that affect human beings. Besides providing clues to understanding human biology, learning about non-human organisms DNA sequences can lead to an understanding of their natural capabilities that can be applied toward solving challenges in health care, agriculture, energy production, environmental remediation. Many non-human model organisms, such as bacteria, yeast, *Caenorhabditis elegans* (a free living non-pathogenic nematode), *Drosophila* (the fruit fly), plants (rice and *Arabidopsis*), etc., have also been sequenced.

**Methodologies :** The methods involved two major approaches. One approach focused on identifying all the genes that are expressed as RNA (referred to as **Expressed Sequence Tags (ESTs)**). The other took the blind approach of simply sequencing the whole set of genome that contained all the coding and non-coding sequence, and later assigning different regions in the sequence with functions (a term referred to as **Sequence Annotation**). For sequencing, the total DNA from a cell is isolated and converted into random fragments of relatively smaller sizes (recall DNA is a very long polymer, and there are technical limitations in sequencing very long pieces of DNA) and cloned in suitable host using specialised vectors. The cloning resulted into amplification of each piece of DNA fragment so that it subsequently could be sequenced with ease. The commonly used hosts were bacteria and yeast, and the vectors were called as **BAC** (bacterial artificial chromosomes), and **YAC** (yeast artificial chromosomes).

The fragments were sequenced using automated DNA sequencers that worked on the principle of a method developed by Frederick Sanger. (Remember, Sanger is also credited for developing method for determination of amino acid sequences in proteins). These sequences were then arranged based on some overlapping regions present in them. This required generation of overlapping fragments for sequencing. Alignment of these sequences was humanly not possible. Therefore, specialised computer based programs were developed (Figure 5.15). These sequences were subsequently annotated and were assigned to each chromosome. The sequence of chromosome 1 was completed only in May 2006 (this was the last of the 24 human chromosomes – 22 autosomes and X and Y – to be



**Figure 5.15** A representative diagram of human genome project



sequenced). Another challenging task was assigning the genetic and physical maps on the genome. This was generated using information on polymorphism of restriction endonuclease recognition sites, and some repetitive DNA sequences known as microsatellites (one of the applications of polymorphism in repetitive DNA sequences shall be explained in next section of DNA fingerprinting).

### 5.9.1 Salient Features of Human Genome

Some of the salient observations drawn from human genome project are as follows:

- (i) The human genome contains 3164.7 million bp.
- (ii) The average gene consists of 3000 bases, but sizes vary greatly, with the largest known human gene being dystrophin at 2.4 million bases.
- (iii) The total number of genes is estimated at 30,000—much lower than previous estimates of 80,000 to 1,40,000 genes. Almost all (99.9 per cent) nucleotide bases are exactly the same in all people.
- (iv) The functions are unknown for over 50 per cent of the discovered genes.
- (v) Less than 2 per cent of the genome codes for proteins.
- (vi) Repeated sequences make up very large portion of the human genome.
- (vii) Repetitive sequences are stretches of DNA sequences that are repeated many times, sometimes hundred to thousand times. They are thought to have no direct coding functions, but they shed light on chromosome structure, dynamics and evolution.
- (viii) Chromosome 1 has most genes (2968), and the Y has the fewest (231).
- (ix) Scientists have identified about 1.4 million locations where single-base DNA differences (**SNPs – single nucleotide polymorphism**, pronounced as ‘snips’) occur in humans. This information promises to revolutionise the processes of finding chromosomal locations for disease-associated sequences and tracing human history.

### 5.9.2 Applications and Future Challenges

Deriving meaningful knowledge from the DNA sequences will define research through the coming decades leading to our understanding of biological systems. This enormous task will require the expertise and creativity of tens of thousands of scientists from varied disciplines in both the public and private sectors worldwide. One of the greatest impacts of having the HG sequence may well be enabling a radically new approach to biological research. In the past, researchers studied one or a few genes at a time. With whole-genome sequences and new high-throughput technologies, we can approach questions systematically and on a much



broader scale. They can study all the genes in a genome, for example, all the transcripts in a particular tissue or organ or tumor, or how tens of thousands of genes and proteins work together in interconnected networks to orchestrate the chemistry of life.

## 5.10 DNA FINGERPRINTING

As stated in the preceding section, 99.9 per cent of base sequence among humans is the same. *Assuming human genome as  $3 \times 10^9$  bp, in how many base sequences would there be differences?* It is these differences in sequence of DNA which make every individual unique in their phenotypic appearance. If one aims to find out genetic differences between two individuals or among individuals of a population, sequencing the DNA every time would be a daunting and expensive task. Imagine trying to compare two sets of  $3 \times 10^6$  base pairs. DNA fingerprinting is a very quick way to compare the DNA sequences of any two individuals.

DNA fingerprinting involves identifying differences in some specific regions in DNA sequence called as **repetitive DNA**, because in these sequences, a small stretch of DNA is repeated many times. These repetitive DNA are separated from bulk genomic DNA as different peaks during density gradient centrifugation. The bulk DNA forms a major peak and the other small peaks are referred to as **satellite DNA**. Depending on base composition (A : T rich or G:C rich), length of segment, and number of repetitive units, the satellite DNA is classified into many categories, such as micro-satellites, mini-satellites etc. These sequences normally do not code for any proteins, but they form a large portion of human genome. These sequence show high degree of polymorphism and form the basis of DNA fingerprinting. Since DNA from every tissue (such as blood, hair-follicle, skin, bone, saliva, sperm etc.), from an individual show the same degree of polymorphism, they become very useful identification tool in forensic applications. Further, as the polymorphisms are inheritable from parents to children, DNA fingerprinting is the basis of paternity testing, in case of disputes.

As polymorphism in DNA sequence is the basis of genetic mapping of human genome as well as of DNA fingerprinting, it is essential that we understand what DNA polymorphism means in simple terms. **Polymorphism** (variation at genetic level) arises due to mutations. (Recall different kind of mutations and their effects that you have already studied in Chapter 4, and in the preceding sections in this chapter.) New mutations may arise in an individual either in somatic cells or in the germ cells (cells that generate gametes in sexually reproducing organisms). If a germ cell mutation does not seriously impair individual's ability to have offspring who can transmit the mutation, it can spread to

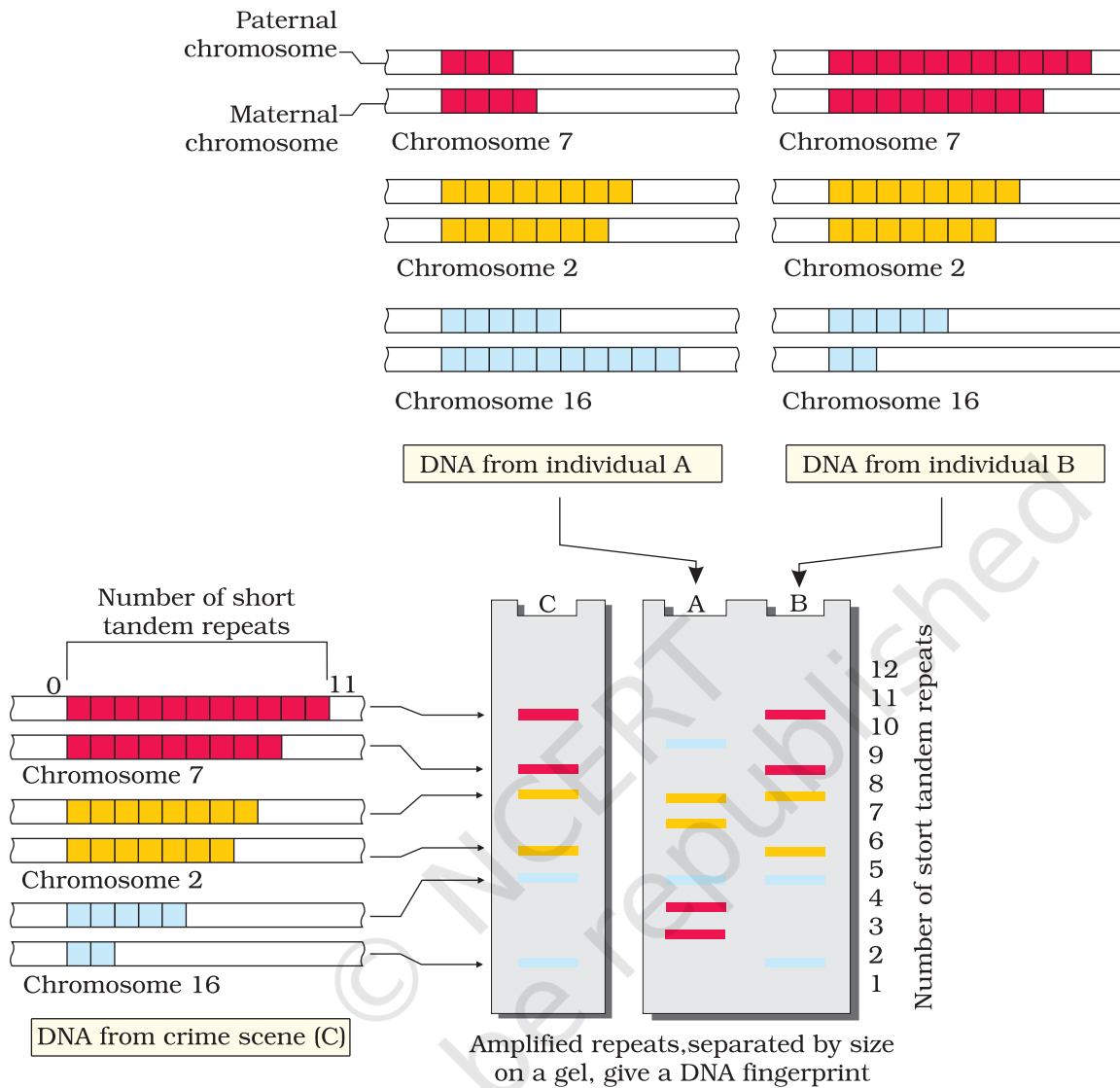


the other members of population (through sexual reproduction). Allelic (again recall the definition of alleles from Chapter 4) sequence variation has traditionally been described as a DNA polymorphism if more than one variant (allele) at a locus occurs in human population with a frequency greater than 0.01. In simple terms, if an **inheritable mutation** is observed in a population at high frequency, it is referred to as **DNA polymorphism**. The probability of such variation to be observed in non-coding DNA sequence would be higher as mutations in these sequences may not have any immediate effect/impact in an individual's reproductive ability. These mutations keep on accumulating generation after generation, and form one of the basis of variability/polymorphism. There is a variety of different types of polymorphisms ranging from single nucleotide change to very large scale changes. For evolution and speciation, such polymorphisms play very important role, and you will study these in details at higher classes.

The technique of DNA Fingerprinting was initially developed by Alec Jeffreys. He used a satellite DNA as probe that shows very high degree of polymorphism. It was called as **Variable Number of Tandem Repeats** (VNTR). The technique, as used earlier, involved Southern blot hybridisation using radiolabelled VNTR as a probe. It included

- (i) isolation of DNA,
- (ii) digestion of DNA by restriction endonucleases,
- (iii) separation of DNA fragments by electrophoresis,
- (iv) transferring (blotting) of separated DNA fragments to synthetic membranes, such as nitrocellulose or nylon,
- (v) hybridisation using labelled VNTR probe, and
- (vi) detection of hybridised DNA fragments by autoradiography. A schematic representation of DNA fingerprinting is shown in Figure 5.16.

The VNTR belongs to a class of satellite DNA referred to as mini-satellite. A small DNA sequence is arranged tandemly in many copy numbers. The copy number varies from chromosome to chromosome in an individual. The numbers of repeat show very high degree of polymorphism. As a result the size of VNTR varies in size from 0.1 to 20 kb. Consequently, after hybridisation with VNTR probe, the autoradiogram gives many bands of differing sizes. These bands give a characteristic pattern for an individual DNA (Figure 5.16). It differs from individual to individual in a population except in the case of monozygotic (identical) twins. The sensitivity of the technique has been increased by use of polymerase chain reaction (PCR—you will study about it in Chapter 9). Consequently, DNA from a single cell is enough to perform DNA fingerprinting analysis. In addition to application in forensic science, it has much wider application, such as



**Figure 5.16** Schematic representation of DNA fingerprinting: Few representative chromosomes have been shown to contain different copy number of VNTR. For the sake of understanding different colour schemes have been used to trace the origin of each band in the gel. The two alleles (paternal and maternal) of a chromosome also contain different copy numbers of VNTR. It is clear that the banding pattern of DNA from crime scene matches with individual B, and not with A.

in determining population and genetic diversities. Currently, many different probes are used to generate DNA fingerprints.

## SUMMARY

Nucleic acids are long polymers of nucleotides. While DNA stores genetic information, RNA mostly helps in transfer and expression of information. Though DNA and RNA both function as genetic material, but DNA being chemically and structurally more stable is a better genetic material. However, RNA is the first to evolve and DNA was derived from RNA. The hallmark of the double stranded helical structure of DNA is the hydrogen bonding between the bases from opposite strands. The rule is that Adenine pairs with Thymine through two H-bonds, and Guanine with Cytosine through three H-bonds. This makes one strand complementary to the other. The DNA replicates semiconservatively, the process is guided by the complementary H-bonding. A segment of DNA that codes for RNA may in a simplistic term can be referred as gene. During transcription also, one of the strands of DNA acts a template to direct the synthesis of complementary RNA. In bacteria, the transcribed mRNA is functional, hence can directly be translated. In eukaryotes, the gene is split. The coding sequences, exons, are interrupted by non-coding sequences, introns. Introns are removed and exons are joined to produce functional RNA by splicing. The messenger RNA contains the base sequences that are read in a combination of three (to make triplet genetic code) to code for an amino acid. The genetic code is read again on the principle of complementarity by tRNA that acts as an adapter molecule. There are specific tRNAs for every amino acid. The tRNA binds to specific amino acid at one end and pairs through H-bonding with codes on mRNA through its anticodons. The site of translation (protein synthesis) is ribosomes, which bind to mRNA and provide platform for joining of amino acids. One of the rRNA acts as a catalyst for peptide bond formation, which is an example of RNA enzyme (ribozyme). Translation is a process that has evolved around RNA, indicating that life began around RNA. Since, transcription and translation are energetically very expensive processes, these have to be tightly regulated. Regulation of transcription is the primary step for regulation of gene expression. In bacteria, more than one gene is arranged together and regulated in units called as operons. *Lac* operon is the prototype operon in bacteria, which codes for genes responsible for metabolism of lactose. The operon is regulated by the amount of lactose in the medium where the bacteria are grown. Therefore, this regulation can also be viewed as regulation of enzyme synthesis by its substrate.

Human genome project was a mega project that aimed to sequence every base in human genome. This project has yielded much new information. Many new areas and avenues have opened up as a consequence of the project. DNA Fingerprinting is a technique to find out variations in individuals of a population at DNA level. It works on the principle of polymorphism in DNA sequences. It has immense applications in the field of forensic science, genetic biodiversity and evolutionary biology.





# EXERCISES

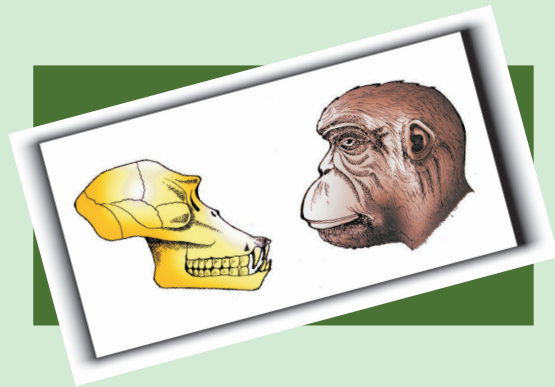
1. Group the following as nitrogenous bases and nucleosides:  
Adenine, Cytidine, Thymine, Guanosine, Uracil and Cytosine.
2. If a double stranded DNA has 20 per cent of cytosine, calculate the per cent of adenine in the DNA.
3. If the sequence of one strand of DNA is written as follows:  
5'-ATGCATGCATGCATGCATGCATGC-3'  
Write down the sequence of complementary strand in 5'-3' direction.
4. If the sequence of the coding strand in a transcription unit is written as follows:  
5'-ATGCATGCATGCATGCATGCATGC-3'  
Write down the sequence of mRNA.
5. Which property of DNA double helix led Watson and Crick to hypothesise semi-conservative mode of DNA replication? Explain.
6. Depending upon the chemical nature of the template (DNA or RNA) and the nature of nucleic acids synthesised from it (DNA or RNA), list the types of nucleic acid polymerases.
7. How did Hershey and Chase differentiate between DNA and protein in their experiment while proving that DNA is the genetic material?
8. Differentiate between the followings:
  - (a) Repetitive DNA and Satellite DNA
  - (b) mRNA and tRNA
  - (c) Template strand and Coding strand
9. List two essential roles of ribosome during translation.
10. In the medium where *E. coli* was growing, lactose was added, which induced the *lac* operon. Then, why does *lac* operon shut down some time after addition of lactose in the medium?
11. Explain (in one or two lines) the function of the followings:
  - (a) Promoter
  - (b) tRNA
  - (c) Exons
12. Why is the Human Genome project called a mega project?
13. What is DNA fingerprinting? Mention its application.
14. Briefly describe the following:
  - (a) Transcription
  - (b) Polymorphism
  - (c) Translation
  - (d) Bioinformatics



12083CH07

## CHAPTER 6

# EVOLUTION



- 6.1 *Origin of Life*
- 6.2 *Evolution of Life Forms - A Theory*
- 6.3 *What are the Evidences for Evolution?*
- 6.4 *What is Adaptive Radiation?*
- 6.5 *Biological Evolution*
- 6.6 *Mechanism of Evolution*
- 6.7 *Hardy - Weinberg Principle*
- 6.8 *A Brief Account of Evolution*
- 6.9 *Origin and Evolution of Man*

Evolutionary Biology is the study of history of life forms on earth. What exactly is evolution? To understand the changes in flora and fauna that have occurred over millions of years on earth, we must have an understanding of the context of origin of life, i.e., evolution of earth, of stars and indeed of the universe itself. What follows is the longest of all the construed and conjectured stories. This is the story of origin of life and evolution of life forms or biodiversity on planet earth in the context of evolution of earth and against the background of evolution of universe itself.

### 6.1 ORIGIN OF LIFE

When we look at stars on a clear night sky we are, in a way, looking back in time. Stellar distances are measured in light years. What we see today is an object whose emitted light started its journey millions of year back and from trillions of kilometres away and reaching our eyes now. However, when we see objects in our immediate surroundings we see them instantly and hence in the present time. Therefore, when we see stars we apparently are peeping into the past.

The origin of life is considered a unique event in the history of universe. The universe is vast. Relatively speaking the earth itself is almost only a speck. The universe is very

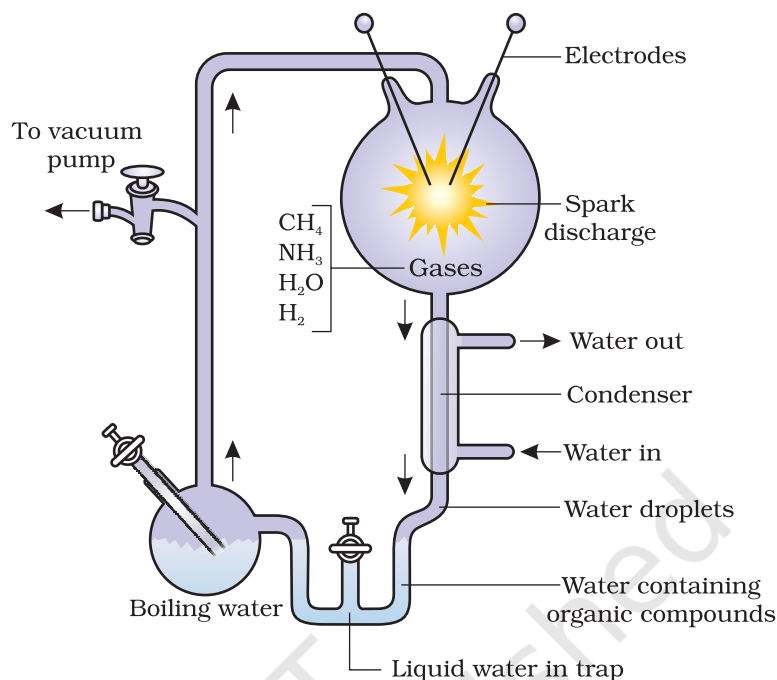


old – almost 20 billion years old. Huge clusters of galaxies comprise the universe. Galaxies contain stars and clouds of gas and dust. Considering the size of universe, earth is indeed a speck. The **Big Bang** theory attempts to explain to us the origin of universe. It talks of a singular huge explosion unimaginable in physical terms. The universe expanded and hence, the temperature came down. Hydrogen and Helium formed sometime later. The gases condensed under gravitation and formed the galaxies of the present day universe. In the solar system of the milky way galaxy, earth was supposed to have been formed about 4.5 billion years back. There was no atmosphere on early earth. Water vapour, methane, carbon dioxide and ammonia released from molten mass covered the surface. The UV rays from the sun broke up water into Hydrogen and Oxygen and the lighter  $H_2$  escaped. Oxygen combined with ammonia and methane to form water,  $CO_2$  and others. The ozone layer was formed. As it cooled, the water vapor fell as rain, to fill all the depressions and form oceans. Life appeared 500 million years after the formation of earth, i.e., almost four billion years back.

Did life come from outer space? Some scientists believe that it came from outside. Early Greek thinkers thought units of life called **spores** were transferred to different planets including earth. 'Panspermia' is still a favourite idea for some astronomers. For a long time it was also believed that life came out of decaying and rotting matter like straw, mud, etc. This was the theory of spontaneous generation. Louis Pasteur by careful experimentation demonstrated that life comes only from pre-existing life. He showed that in pre-sterilised flasks, life did not come from killed yeast while in another flask open to air, new living organisms arose from 'killed yeast'. Spontaneous generation theory was dismissed once and for all. However, this did not answer how the first life form came on earth.

Oparin of Russia and Haldane of England proposed that the first form of life could have come from pre-existing non-living organic molecules (e.g. RNA, protein, etc.) and that formation of life was preceded by chemical evolution, i.e., formation of diverse organic molecules from inorganic constituents. The conditions on earth were – high temperature, volcanic storms, reducing atmosphere containing  $CH_4$ ,  $NH_3$ , etc. In 1953, S.L. Miller, an American scientist created similar conditions in a laboratory scale (Figure 6.1). He created electric discharge in a closed flask containing  $CH_4$ ,  $H_2$ ,  $NH_3$  and water vapour at  $800^\circ C$ . He observed formation of amino acids. In similar experiments others observed, formation of sugars, nitrogen bases, pigment and fats. Analysis of meteorite content also revealed similar compounds indicating that similar processes are occurring elsewhere in space. With this limited evidence, the first part of the conjectured story, i.e., chemical evolution was more or less accepted.

We have no idea about how the first self replicating metabolic capsule of life arose. The first non-cellular forms of life could have originated 3 billion years back. They would have been giant molecules (RNA, Protein,



**Figure 6.1** Diagrammatic representation of Miller's experiment

Polysaccharides, etc.). These capsules reproduced their molecules perhaps. The first cellular form of life did not possibly originate till about 2000 million years ago. These were probably single-cells. All life forms were in water environment only. This version of a biogenesis, i.e., the first form of life arose slowly through evolutionary forces from non-living molecules is accepted by majority. However, once formed, how the first cellular forms of life could have evolved into the complex biodiversity of today is the fascinating story that will be discussed below.

## 6.2 EVOLUTION OF LIFE FORMS – A THEORY

Conventional religious literature tells us about the theory of special creation. This theory has three connotations. One, that all living organisms (species or types) that we see today were created as such. Two, that the diversity was always the same since creation and will be the same in future also. Three, that earth is about 4000 years old. All these ideas were strongly challenged during the nineteenth century. Based on observations made during a sea voyage in a sail ship called H.M.S. Beagle round the world, Charles Darwin concluded that existing living forms share similarities to varying degrees not only among themselves but also with life forms that existed millions of years ago. Many such life forms do not exist any more. There had been extinctions of different life forms in the years gone by just as new forms of life arose at different periods of history of earth. There has been gradual evolution of life forms. Any population



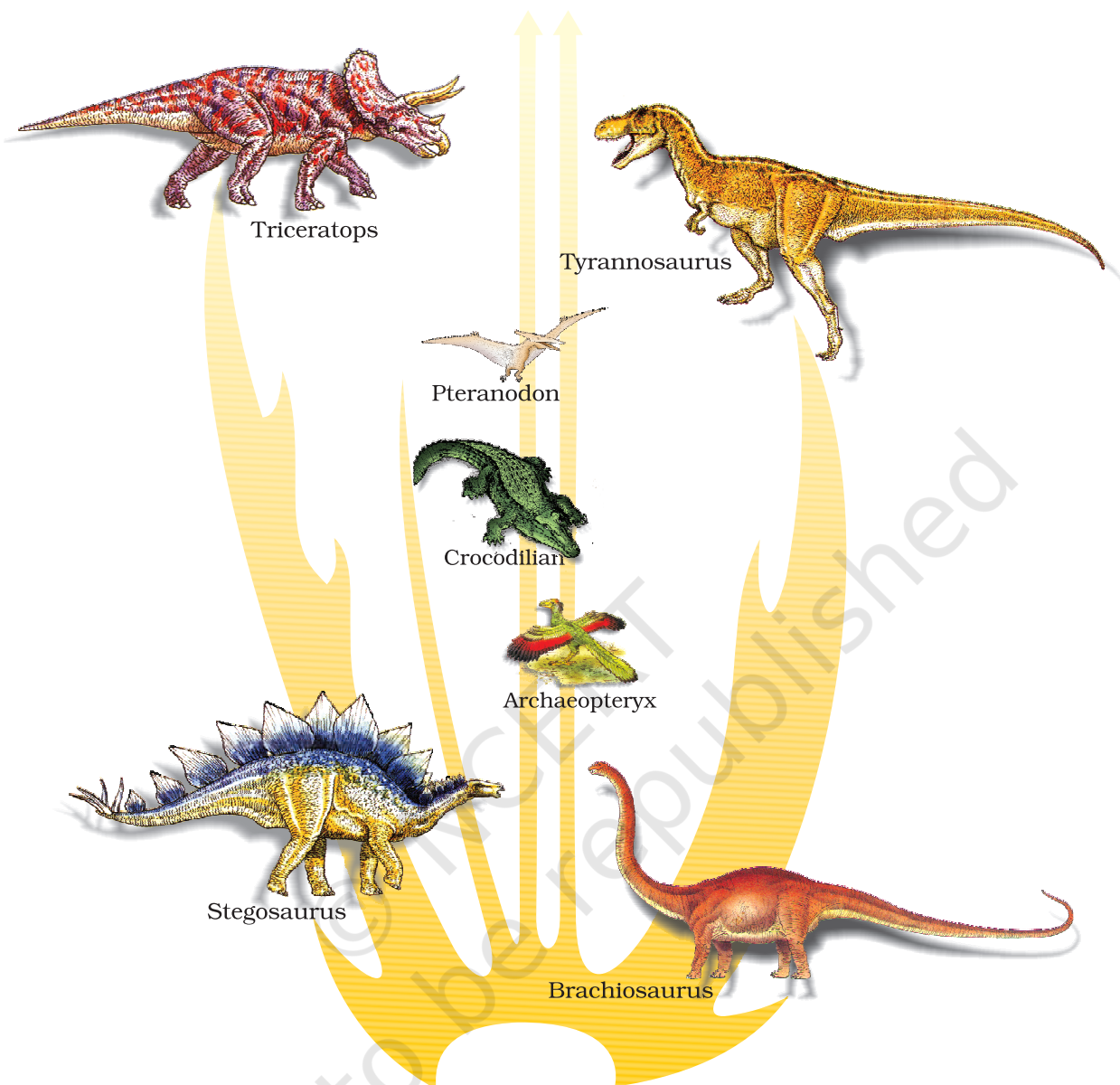
has built in variation in characteristics. Those characteristics which enable some to survive better in natural conditions (climate, food, physical factors, etc.) would outbreed others that are less-endowed to survive under such natural conditions. Another word used is fitness of the individual or population. The fitness, according to Darwin, refers ultimately and only to reproductive fitness. Hence, those who are better fit in an environment, leave more progeny than others. These, therefore, will survive more and hence are selected by nature. He called it natural selection and implied it as a mechanism of evolution. Let us also remember that Alfred Wallace, a naturalist who worked in Malay Archipelago had also come to similar conclusions around the same time. In due course of time, apparently new types of organisms are recognisable. All the existing life forms share similarities and share common ancestors. However, these ancestors were present at different periods in the history of earth (epochs, periods and eras). The geological history of earth closely correlates with the biological history of earth. A common permissible conclusion is that earth is very old, not thousand of years as was thought earlier but billions of years old.

### 6.3 WHAT ARE THE EVIDENCES FOR EVOLUTION?

Evidence that evolution of life forms has indeed taken place on earth has come from many quarters. Fossils are remains of hard parts of life-forms found in rocks. Rocks form sediments and a cross-section of earth's crust indicates the arrangement of sediments one over the other during the long history of earth. Different-aged rock sediments contain fossils of different life-forms who probably died during the formation of the particular sediment. Some of them appear similar to modern organisms (Figure 6.2). They represent extinct organisms (e.g., Dinosaurs). A study of fossils in different sedimentary layers indicates the geological period in which they existed. The study showed that life-forms varied over time and certain life forms are restricted to certain geological time-spans. Hence, new forms of life have arisen at different times in the history of earth. All this is called paleontological evidence. *Do you remember how the ages of the fossils are calculated? Do you recollect the method of radioactive-dating and the principles behind the procedure?*

**Embryological support for evolution** was also proposed by Ernst Haeckel based upon the observation of certain features during embryonic stage common to all vertebrates that are absent in adult. For example, the embryos of all vertebrates including human develop a row of vestigial gill slit just behind the head but it is a functional organ only in fish and not found in any other adult vertebrates. However, this proposal was disapproved on careful study performed by Karl Ernst von Baer. He noted that embryos never pass through the adult stages of other animals.

Comparative anatomy and morphology shows similarities and differences among organisms of today and those that existed years ago.



**Figure 6.2** A family tree of dinosaurs and their living modern day counterpart organisms like crocodiles and birds

Such similarities can be interpreted to understand whether common ancestors were shared or not. For example whales, bats, Cheetah and human (all mammals) share similarities in the pattern of bones of forelimbs (Figure 6.3b). Though these forelimbs perform different functions in these animals, they have similar anatomical structure – all of them have humerus, radius, ulna, carpals, metacarpals and phalanges in their forelimbs. Hence, in these animals, the same structure developed along different directions due to adaptations to different needs. This is **divergent evolution** and these structures are **homologous**. Homology indicates common ancestry. Other examples are vertebrate hearts or brains. In

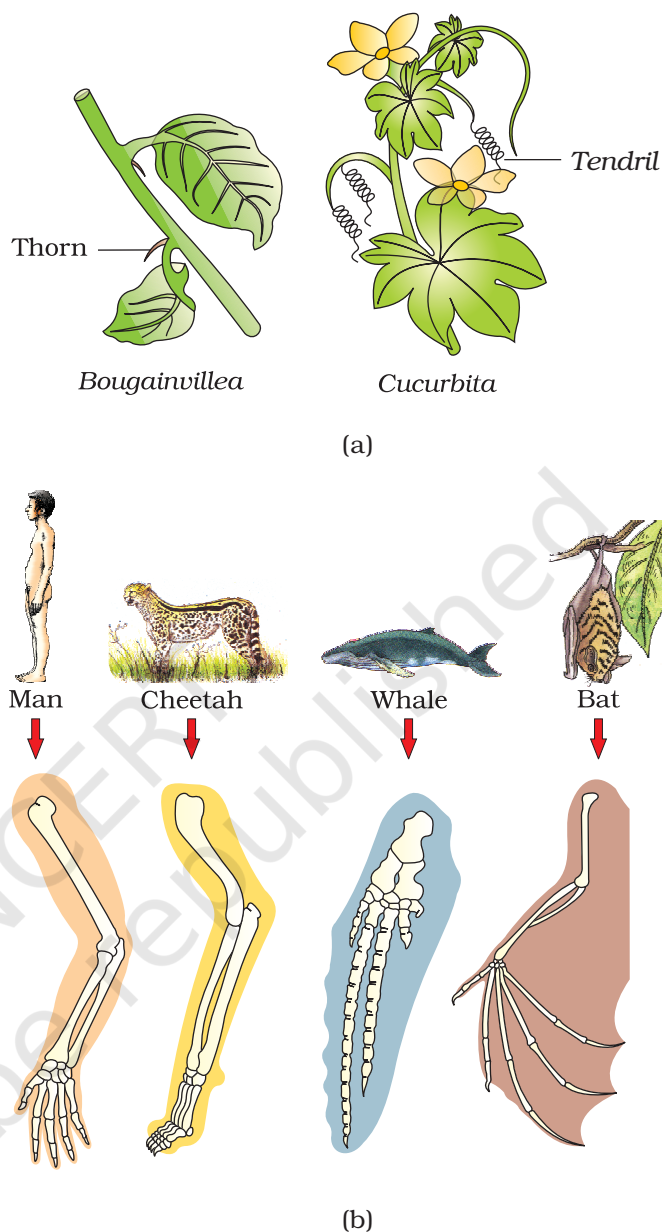


plants also, the thorn and tendrils of *Bougainvillea* and *Cucurbita* represent homology (Figure 6.3a). Homology is based on divergent evolution whereas analogy refers to a situation exactly opposite. Wings of butterfly and of birds look alike. They are not anatomically similar structures though they perform similar functions. Hence, analogous structures are a result of **convergent evolution** - different structures evolving for the same function and hence having similarity. Other examples of analogy are the eye of the octopus and of mammals or the flippers of Penguins and Dolphins. One can say that it is the similar habitat that has resulted in selection of similar adaptive features in different groups of organisms but toward the same function: Sweet potato (root modification) and potato (stem modification) is another example for analogy.

In the same line of argument, similarities in proteins and genes performing a given function among diverse organisms give clues to common ancestry. These biochemical similarities point to the same shared ancestry as structural similarities among diverse organisms.

Man has bred selected plants and animals for agriculture, horticulture, sport or security. Man has domesticated many wild animals and crops. This intensive breeding programme has created breeds that differ from other breeds (e.g., dogs) but still are of the same group. It is argued that if within hundreds of years, man could create new breeds, could not nature have done the same over millions of years?

Another interesting observation supporting evolution by natural selection comes from England. In a collection of moths made in 1850s, i.e., before industrialisation set in, it was observed that there were more white-winged moths on trees than dark-winged or melanised moths. However, in the collection carried out from the same area, but after industrialisation, i.e., in 1920, there were more dark-winged moths in the same area, i.e., the proportion was reversed.



**Figure 6.3** Example of homologous organs in (a) Plants and (b) Animals



**Figure 6.4** Figure showing white - winged moth and dark - winged moth (melanised) on a tree trunk (a) In unpolluted area (b) In polluted area

The explanation put forth for this observation was that 'predators will spot a moth against a contrasting background'. During post-industrialisation period, the tree trunks became dark due to industrial smoke and soots. Under this condition the white-winged moth did not survive due to predators, dark-winged or melanised moth survived. Before industrialisation set in, thick growth of almost white-coloured lichen covered the trees - in that background the white winged moth survived but the dark-coloured moth were picked out by predators. *Do you know that lichens can be used as industrial pollution indicators?* They will not grow in areas that are polluted. Hence, moths that were able to camouflage themselves, i.e., hide in the background, survived (Figure 6.4). This understanding is supported by the fact that in areas where industrialisation did not occur e.g., in rural areas, the count of melanic moths was low. This showed that in a mixed population, those that can better-adapt, survive and increase in population size. Remember that no variant is completely wiped out.

Similarly, excess use of herbicides, pesticides, etc., has only resulted in selection of resistant varieties in a much lesser time scale. This is also true for microbes against which we employ antibiotics or drugs against eukaryotic organisms/cell. Hence, resistant organisms/cells are appearing in a time scale of months or years and not centuries. These are examples of evolution by anthropogenic action. This also tells us that evolution is not a directed process in the sense of determinism. It is a stochastic process based on chance events in nature and chance mutation in the organisms.

## 6.4 WHAT IS ADAPTIVE RADIATION?

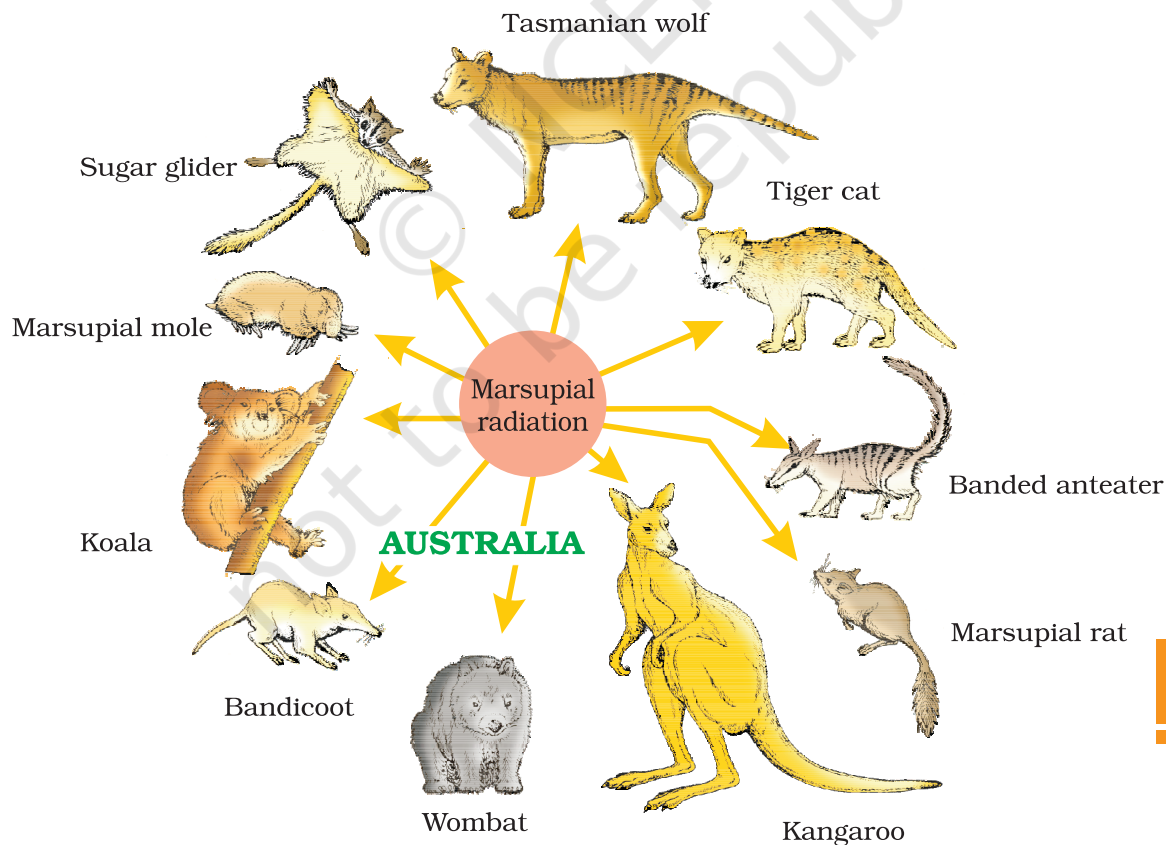
During his journey Darwin went to Galapagos Islands. There he observed an amazing diversity of creatures. Of particular interest, small black birds later called Darwin's Finches amazed him. He realised that there were many



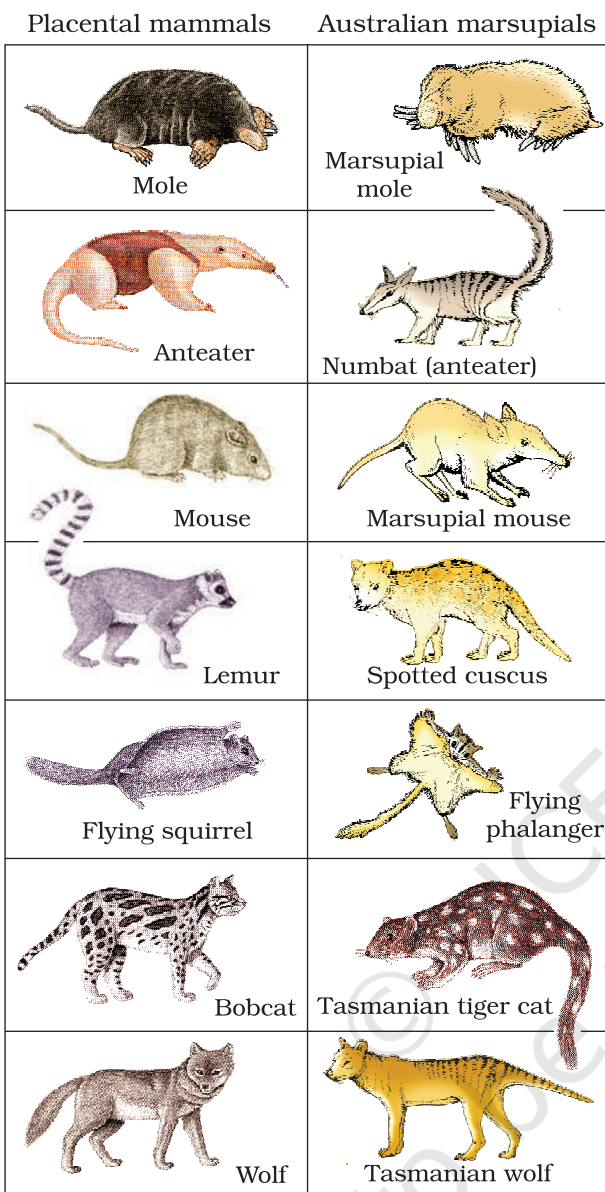


**Figure 6.5** Variety of beaks of finches that Darwin found in Galapagos Island

varieties of finches in the same island. All the varieties, he conjectured, evolved on the island itself. From the original seed-eating features, many other forms with altered beaks arose, enabling them to become insectivorous and vegetarian finches (Figure 6.5). This process of evolution of different species in a given geographical area starting from a point and literally radiating to other areas of geography (habitats) is called **adaptive radiation**. Darwin's finches represent one of the best examples of this phenomenon. Another example is Australian marsupials. A number of marsupials, each different from the other (Figure 6.6) evolved from an ancestral stock, but all within the Australian island continent. When more than one adaptive radiation appeared to have occurred in an isolated geographical area (representing



**Figure 6.6** Adaptive radiation of marsupials of Australia



**Figure 6.7** Picture showing convergent evolution of Australian Marsupials and placental mammals

different habitats), one can call this convergent evolution. Placental mammals in Australia also exhibit adaptive radiation in evolving into varieties of such placental mammals each of which appears to be 'similar' to a corresponding marsupial (e.g., Placental wolf and Tasmanian wolf-marsupial). (Figure 6.7).

## 6.5 BIOLOGICAL EVOLUTION

Evolution by natural selection, in a true sense would have started when cellular forms of life with differences in metabolic capability originated on earth.

The essence of Darwinian theory about evolution is natural selection. The rate of appearance of new forms is linked to the life cycle or the life span. Microbes that divide fast have the ability to multiply and become millions of individuals within hours. A colony of bacteria (say A) growing on a given medium has built-in variation in terms of ability to utilise a feed component. A change in the medium composition would bring out only that part of the population (say B) that can survive under the new conditions. In due course of time this variant population outgrows the others and appears as new species. This would happen within days. For the same thing to happen in a fish or fowl would take million of years as life spans of these animals are in years. Here we say that fitness of B is better than that of A under the new conditions. Nature selects for fitness. One must remember that the so-called fitness is based on characteristics which are inherited.

Hence, there must be a genetic basis for getting selected and to evolve. Another way of saying the same thing is that some organisms are better adapted to survive in an otherwise hostile environment. Adaptive ability is inherited. It has a genetic basis. Fitness is the end result of the ability to adapt and get selected by nature.

**Branching descent** and **natural selection** are the two key concepts of Darwinian Theory of Evolution (Figures 6.7 and 6.8).

Even before Darwin, a French naturalist Lamarck had said that evolution of life forms had occurred but driven by use and disuse of



organs. He gave the examples of Giraffes who in an attempt to forage leaves on tall trees had to adapt by elongation of their necks. As they passed on this acquired character of elongated neck to succeeding generations, Giraffes, slowly, over the years, came to acquire long necks. Nobody believes this conjecture any more.

Is evolution a process or the result of a process? The world we see, inanimate and animate, is only the success stories of evolution. When we describe the story of this world we describe evolution as a process. On the other hand when we describe the story of life on earth, we treat evolution as a consequence of a process called natural selection. We are still not very clear whether to regard evolution and natural selection as processes or end result of unknown processes.

It is possible that the work of Thomas Malthus on populations influenced Darwin. Natural selection is based on certain observations which are factual. For example, natural resources are limited, populations are stable in size except for seasonal fluctuation, members of a population vary in characteristics (infact no two individuals are alike) even though they look superficially similar, most of variations are inherited etc. The fact that theoretically population size will grow exponentially if everybody reproduced maximally (this fact can be seen in a growing bacterial population) and the fact that population sizes in reality are limited, means that there had been competition for resources. Only some survived and grew at the cost of others that could not flourish. The novelty and brilliant insight of Darwin was this: he asserted that variations, which are heritable and which make resource utilisation better for few (adapted to habitat better) will enable only those to reproduce and leave more progeny. Hence for a period of time, over many generations, survivors will leave more progeny and there would be a change in population characteristic and hence new forms appear to arise.

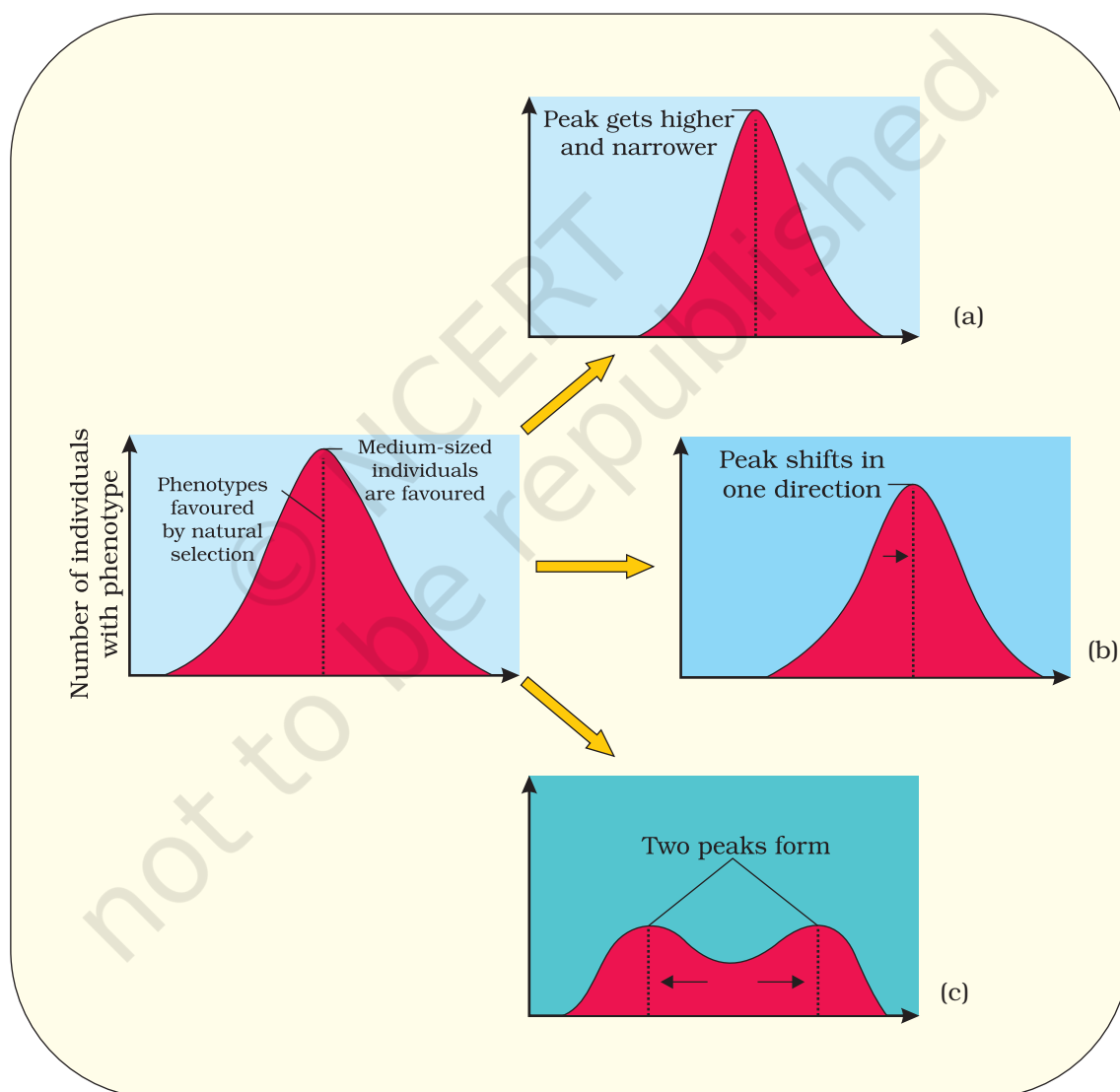
## 6.6 MECHANISM OF EVOLUTION

What is the origin of this variation and how does speciation occur? Even though Mendel had talked of inheritable 'factors' influencing phenotype, Darwin either ignored these observations or kept silence. In the first decade of twentieth century, Hugo deVries based on his work on evening primrose brought forth the idea of mutations – large difference arising suddenly in a population. He believed that it is mutation which causes evolution and not the minor variations (heritable) that Darwin talked about. Mutations are random and directionless while Darwinian variations are small and directional. Evolution for Darwin was gradual while deVries believed mutation caused speciation and hence called it **saltation** (single step large mutation). Studies in population genetics, later, brought out some clarity.

## 6.7 HARDY-WEINBERG PRINCIPLE

In a given population one can find out the frequency of occurrence of alleles of a gene or a locus. This frequency is supposed to remain fixed and even remain the same through generations. Hardy-Weinberg principle stated it using algebraic equations.

This principle says that allele frequencies in a population are stable and is constant from generation to generation. The gene pool (total genes and their alleles in a population) remains a constant. This is called genetic equilibrium. Sum total of all the allelic frequencies is 1. Individual



**Figure 6.8** Diagrammatic representation of the operation of natural selection on different traits : (a) Stabilising (b) Directional and (c) Disruptive



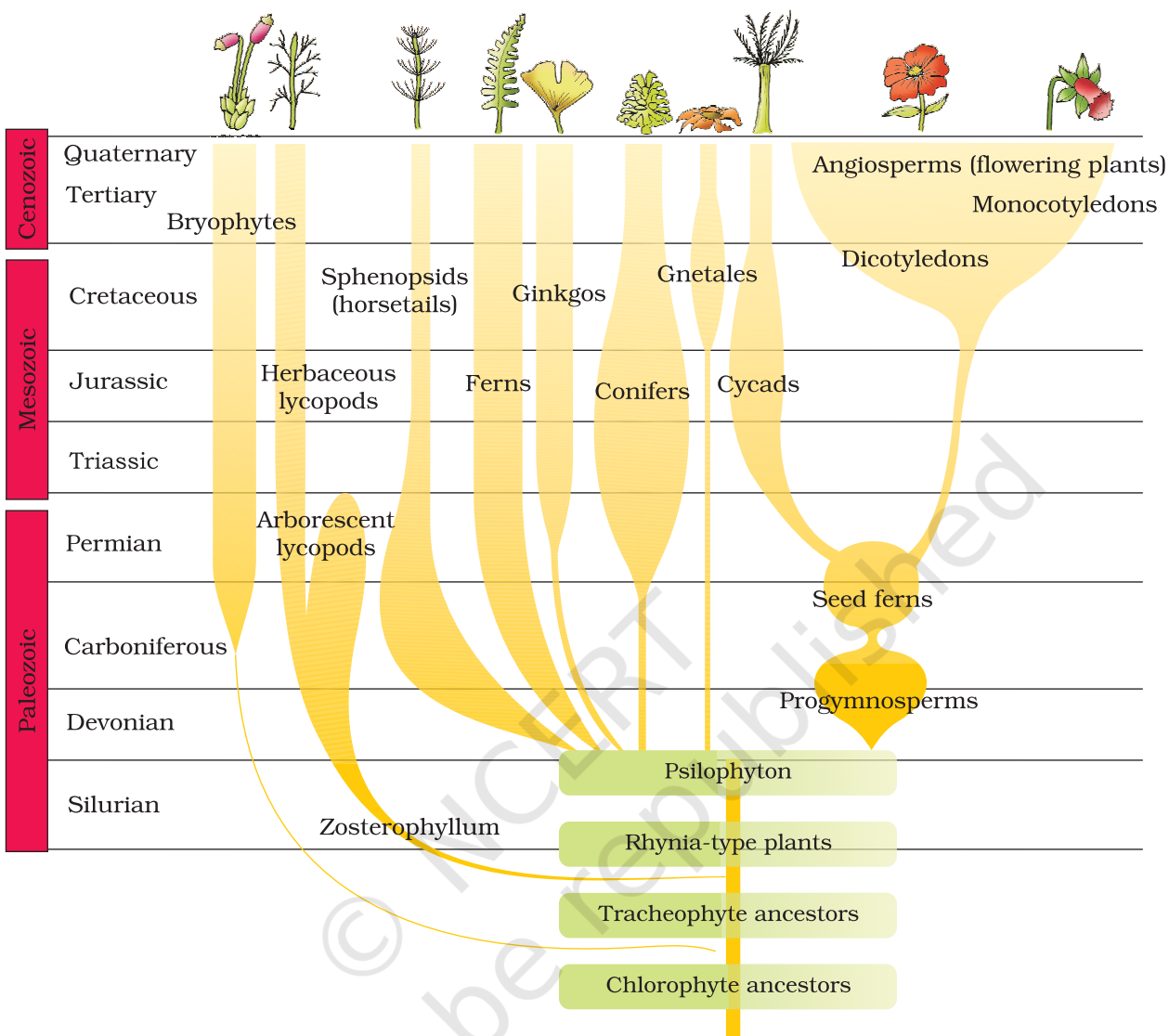
frequencies, for example, can be named  $p$ ,  $q$ , etc. In a diploid,  $p$  and  $q$  represent the frequency of allele  $A$  and allele  $a$ . The frequency of  $AA$  individuals in a population is simply  $p^2$ . This is simply stated in another way, i.e., the probability that an allele  $A$  with a frequency of  $p$  appear on both the chromosomes of a diploid individual is simply the product of the probabilities, i.e.,  $p^2$ . Similarly of  $aa$  is  $q^2$ , of  $Aa$   $2pq$ . Hence,  $p^2+2pq+q^2=1$ . This is a binomial expansion of  $(p+q)^2$ . When frequency measured, differs from expected values, the difference (direction) indicates the extent of evolutionary change. Disturbance in genetic equilibrium, or Hardy-Weinberg equilibrium, i.e., change of frequency of alleles in a population would then be interpreted as resulting in evolution.

Five factors are known to affect Hardy-Weinberg equilibrium. These are gene migration or gene flow, genetic drift, mutation, genetic recombination and natural selection. When migration of a section of population to another place and population occurs, gene frequencies change in the original as well as in the new population. New genes/alleles are added to the new population and these are lost from the old population. There would be a gene flow if this gene migration, happens multiple times. If the same change occurs by chance, it is called genetic drift. Sometimes the change in allele frequency is so different in the new sample of population that they become a different species. The original drifted population becomes founders and the effect is called **founder effect**.

Microbial experiments show that pre-existing advantageous mutations when selected will result in observation of new phenotypes. Over few generations, this would result in Speciation. Natural selection is a process in which heritable variations enabling better survival are enabled to reproduce and leave greater number of progeny. A critical analysis makes us believe that variation due to mutation or variation due to recombination during gametogenesis, or due to gene flow or genetic drift results in changed frequency of genes and alleles in future generation. Coupled to enhance reproductive success, natural selection makes it look like different population. Natural selection can lead to stabilisation (in which more individuals acquire mean character value), directional change (more individuals acquire value other than the mean character value) or disruption (more individuals acquire peripheral character value at both ends of the distribution curve) (Figure 6.8).

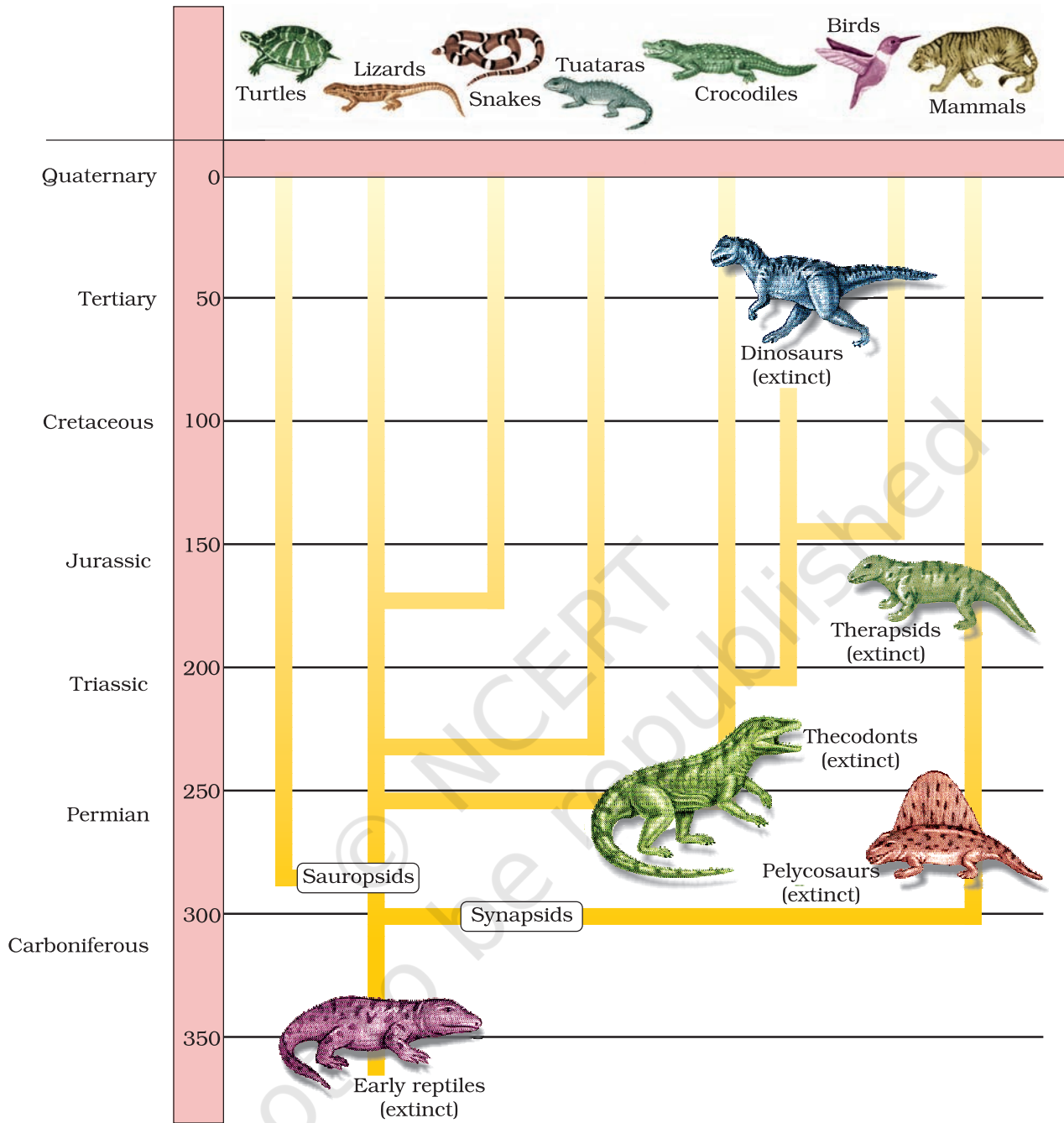
## 6.8 A BRIEF ACCOUNT OF EVOLUTION

About 2000 million years ago (mya) the first cellular forms of life appeared on earth. The mechanism of how non-cellular aggregates of giant macromolecules could evolve into cells with membranous envelop is not known. Some of these cells had the ability to release  $O_2$ . The reaction



**Figure 6.9** A sketch of the evolution of plant forms through geological periods

could have been similar to the light reaction in photosynthesis where water is split with the help of solar energy captured and channelised by appropriate light harvesting pigments. Slowly single-celled organisms became multi-cellular life forms. By the time of 500 mya, invertebrates were formed and active. Jawless fish probably evolved around 350 mya. Sea weeds and few plants existed probably around 320 mya. We are told that the first organisms that invaded land were plants. They were widespread on land when animals invaded land. Fish with stout and strong fins could move on land and go back to water. This was about 350 mya. In 1938, a fish caught in South Africa happened to be a Coelacanth which was thought to be extinct. These animals called lobefins evolved into the



**Figure 6.10** Representative evolutionary history of vertebrates through geological periods

first amphibians that lived on both land and water. There are no specimens of these left with us. However, these were ancestors of modern day frogs and salamanders. The amphibians evolved into reptiles. They lay thick-shelled eggs which do not dry up in sun unlike those of amphibians. Again we only see their modern day descendents, the turtles, tortoises and crocodiles. In the next 200 millions years or so, reptiles of different



shapes and sizes dominated on earth. Giant ferns (pteridophytes) were present but they all fell to form coal deposits slowly. Some of these land reptiles went back into water to evolve into fish like reptiles probably 200 mya (e.g. *Ichthyosaurs*). The land reptiles were, of course, the dinosaurs. The biggest of them, i.e., *Tyrannosaurus rex* was about 20 feet in height and had huge fearsome dagger like teeth. About 65 mya, the dinosaurs suddenly disappeared from the earth. We do not know the true reason. Some say climatic changes killed them. Some say most of them evolved into birds. The truth may live in between. Small sized reptiles of that era still exist today.

The first mammals were like shrews. Their fossils are small sized. Mammals were viviparous and protected their unborn young inside the mother's body. Mammals were more intelligent in sensing and avoiding danger at least. When reptiles came down mammals took over this earth. There were in South America mammals resembling horse, hippopotamus, bear, rabbit, etc. Due to continental drift, when South America joined North America, these animals were overridden by North American fauna. Due to the same continental drift pouched mammals of Australia survived because of lack of competition from any other mammal.

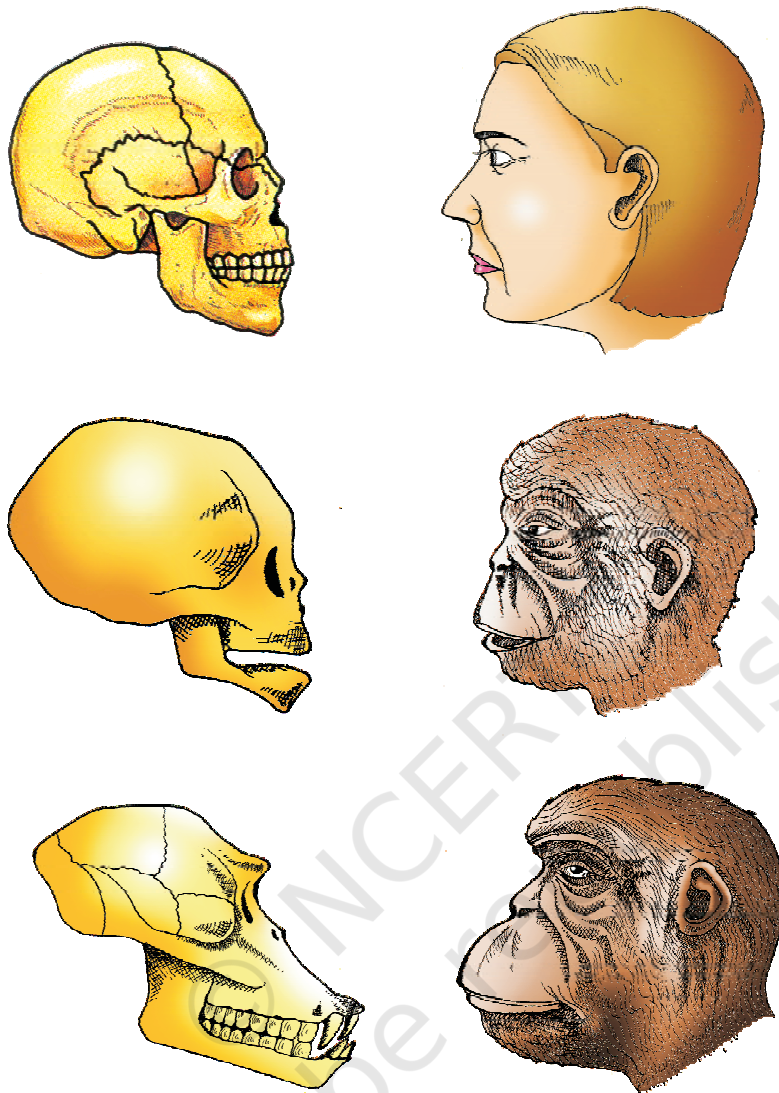
Lest we forget, some mammals live wholly in water. Whales, dolphins, seals and sea cows are some examples. Evolution of horse, elephant, dog, etc., are special stories of evolution. You will learn about these in higher classes. The most successful story is the evolution of man with language skills and self-consciousness.

A rough sketch of the evolution of life forms, their times on a geological scale are indicated in (Figures 6.9 and 6.10).

## 6.9 ORIGIN AND EVOLUTION OF MAN

About 15 mya, primates called *Dryopithecus* and *Ramapithecus* were existing. They were hairy and walked like gorillas and chimpanzees. *Ramapithecus* was more man-like while *Dryopithecus* was more ape-like. Few fossils of man-like bones have been discovered in Ethiopia and Tanzania (Figure 6.11). These revealed hominid features leading to the belief that about 3-4 mya, man-like primates walked in eastern Africa. They were probably not taller than 4 feet but walked up right. Two mya, *Australopithecines* probably lived in East African grasslands. Evidence shows they hunted with stone weapons but essentially ate fruit. Some of the bones among the bones discovered were different. This creature was called the first human-like being the hominid and was called *Homo habilis*. The brain capacities were between 650-800cc. They probably did not eat meat. Fossils discovered in Java in 1891 revealed the next stage, i.e., *Homo erectus* about 1.5 mya. *Homo erectus* had a large brain around 900cc.





**Figure 6.11** A comparison of the skulls of adult modern human being, baby chimpanzee and adult chimpanzee. The skull of baby chimpanzee is more like adult human skull than adult chimpanzee skull

*Homo erectus* probably ate meat. The Neanderthal man with a brain size of 1400cc lived in near east and central Asia between 1,00,000-40,000 years back. They used hides to protect their body and buried their dead. *Homo sapiens* arose in Africa and moved across continents and developed into distinct races. During ice age between 75,000-10,000 years ago modern *Homo sapiens* arose. Pre-historic cave art developed about 18,000 years ago. One such cave paintings by Pre-historic humans can be seen at Bhimbetka rock shelter in Raisen district of Madhya Pradesh. Agriculture came around 10,000 years back and human settlements started. The rest of what happened is part of human history of growth and decline of civilisations.

## SUMMARY

The origin of life on earth can be understood only against the background of origin of universe especially earth. Most scientists believe chemical evolution, i.e., formation of biomolecules preceded the appearance of the first cellular forms of life. The subsequent events as to what happened to the first form of life is a conjectured story based on Darwinian ideas of organic evolution by natural selection. Diversity of life forms on earth has been changing over millions of years. It is generally believed that variations in a population result in variable fitness. Other phenomena like habitat fragmentation and genetic drift may accentuate these variations leading to appearance of new species and hence evolution. Homology is accounted for by the idea of branching descent. Study of comparative anatomy, fossils and comparative biochemistry provides evidence for evolution. Among the stories of evolution of individual species, the story of evolution of modern man is most interesting and appears to parallel evolution of human brain and language.

## EXERCISES

1. Explain antibiotic resistance observed in bacteria in light of Darwinian selection theory.
2. Find out from newspapers and popular science articles any new fossil discoveries or controversies about evolution.
3. Attempt giving a clear definition of the term species.
4. Try to trace the various components of human evolution (hint: brain size and function, skeletal structure, dietary preference, etc.)
5. Find out through internet and popular science articles whether animals other than man has self-consciousness.
6. List 10 modern-day animals and using the internet resources link it to a corresponding ancient fossil. Name both.
7. Practise drawing various animals and plants.
8. Describe one example of adaptive radiation.
9. Can we call human evolution as adaptive radiation?
10. Using various resources such as your school Library or the internet and discussions with your teacher, trace the evolutionary stages of any one animal, say horse.

# UNIT VIII

# BIOLOGY IN HUMAN WELFARE

## **Chapter 7**

Human Health and Disease

## **Chapter 8**

Microbes in Human Welfare

Biology is the youngest of the formalised disciplines of natural science. Progress in physics and chemistry proceeded much faster than in Biology. Applications of physics and chemistry in our daily life also have a higher visibility than those of biology. However, twentieth century and certainly twenty-first century has demonstrated the utility of biological knowledge in furthering human welfare, be it in health sector or agriculture. The discovery of antibiotics, and synthetic plant-derived drugs, anaesthetics have changed medical practice on one hand and human health on the other hand. Life expectancy of human beings have dramatically changed over the years. Agricultural practices, food processing and diagnostics have brought socio-cultural changes in human communities. These are briefly described in the following three chapters of this unit.





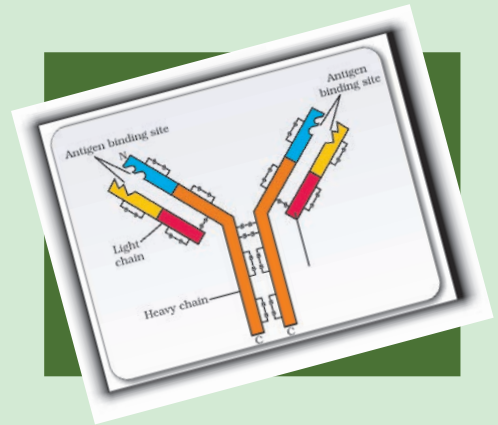
M.S. SWAMINATHAN  
(1925)

Born in August 1925 in Kumbakonam in Tamil Nadu, Monkambu Sambasivan Swaminathan did his graduation and post-graduation in Botany from Madras University. He worked in different capacities in large number of institutions in India and abroad and developed his expertise in genetics and plant breeding.

The School of Cytogenetics and Radiation Research established at the Indian Agricultural Research Institute (IARI) enabled Swaminathan and his team to develop short-duration high-yielding varieties of rice including scented Basmati. He is also known for the development of the concept of crop cafeteria, crop scheduling and genetically improving the yield and quality.

Swaminathan initiated collaboration with Norman Borlaug, which culminated in the 'Green Revolution' through introduction of Mexican varieties of wheat in India. This was highly recognised and appreciated. He is also the initiator of 'Lab-to-Land', food security and several other environmental programmes. He has been honoured with Padma Bhushan and several other prestigious awards, medals and fellowships by institutions of excellence.

# CHAPTER 7



# HUMAN HEALTH AND DISEASE

- 7.1 *Common Diseases in Humans*
- 7.2 *Immunity*
- 7.3 *AIDS*
- 7.4 *Cancer*
- 7.5 *Drugs and Alcohol Abuse*

Health, for a long time, was considered as a state of body and mind where there was a balance of certain 'humors'. This is what early Greeks like Hippocrates as well as Indian Ayurveda system of medicine asserted. It was thought that persons with 'blackbile' belonged to hot personality and would have fevers. This idea was arrived at by pure reflective thought. The discovery of blood circulation by William Harvey using experimental method and the demonstration of normal body temperature in persons with blackbile using thermometer disproved the 'good humor' hypothesis of health. In later years, biology stated that mind influences, through neural system and endocrine system, our immune system and that our immune system maintains our health. Hence, mind and mental state can affect our health. Of course, health is affected by –

- (i) genetic disorders – deficiencies with which a child is born and deficiencies/defects which the child inherits from parents from birth;
- (ii) infections and
- (iii) life style including food and water we take, rest and exercise we give to our bodies, habits that we have or lack etc.



The term **health** is very frequently used by everybody. *How do we define it?* Health does not simply mean 'absence of disease' or 'physical fitness'. It could be defined as a state of complete physical, mental and social well-being. When people are healthy, they are more efficient at work. This increases productivity and brings economic prosperity. Health also increases longevity of people and reduces infant and maternal mortality.

Balanced diet, personal hygiene and regular exercise are very important to maintain good health. Yoga has been practised since time immemorial to achieve physical and mental health. Awareness about diseases and their effect on different bodily functions, vaccination (immunisation) against infectious diseases, proper disposal of wastes, control of vectors and maintenance of hygiene in food and water resources are necessary for achieving good health.

When the functioning of one or more organs or systems of the body is adversely affected, characterised by appearance of various signs and symptoms, we say that we are not healthy, i.e., we have a **disease**. Diseases can be broadly grouped into **infectious** and **non-infectious**. Diseases which are easily transmitted from one person to another, are called **infectious diseases**. Infectious diseases are very common and every one of us suffers from these at sometime or other. Some of the infectious diseases like AIDS are fatal. Among non-infectious diseases, cancer is the major cause of death. Drug and alcohol abuse also affect our health adversely.

## 7.1 COMMON DISEASES IN HUMANS

A wide range of organisms belonging to bacteria, viruses, fungi, protozoans, helminths, etc., could cause diseases in man. Such disease-causing organisms are called **pathogens**. Most parasites are therefore pathogens as they cause harm to the host by living in (or on) them. The pathogens can enter our body by various means, multiply and interfere with normal vital activities, resulting in morphological and functional damage. Pathogens have to adapt to life within the environment of the host. For example, the pathogens that enter the gut must know a way of surviving in the stomach at low pH and resisting the various digestive enzymes. A few representative members from different groups of pathogenic organisms are discussed here alongwith the diseases caused by them. Preventive and control measures against these diseases in general, are also briefly described.

*Salmonella typhi* is a pathogenic bacterium which causes **typhoid** fever in human beings. These pathogens generally enter the small intestine through food and water contaminated with them and migrate to other organs through blood. Sustained high fever (39° to 40°C), weakness, stomach pain, constipation, headache and loss of appetite are some of the common symptoms of this disease. Intestinal perforation and death may occur in severe cases. Typhoid fever could be confirmed by



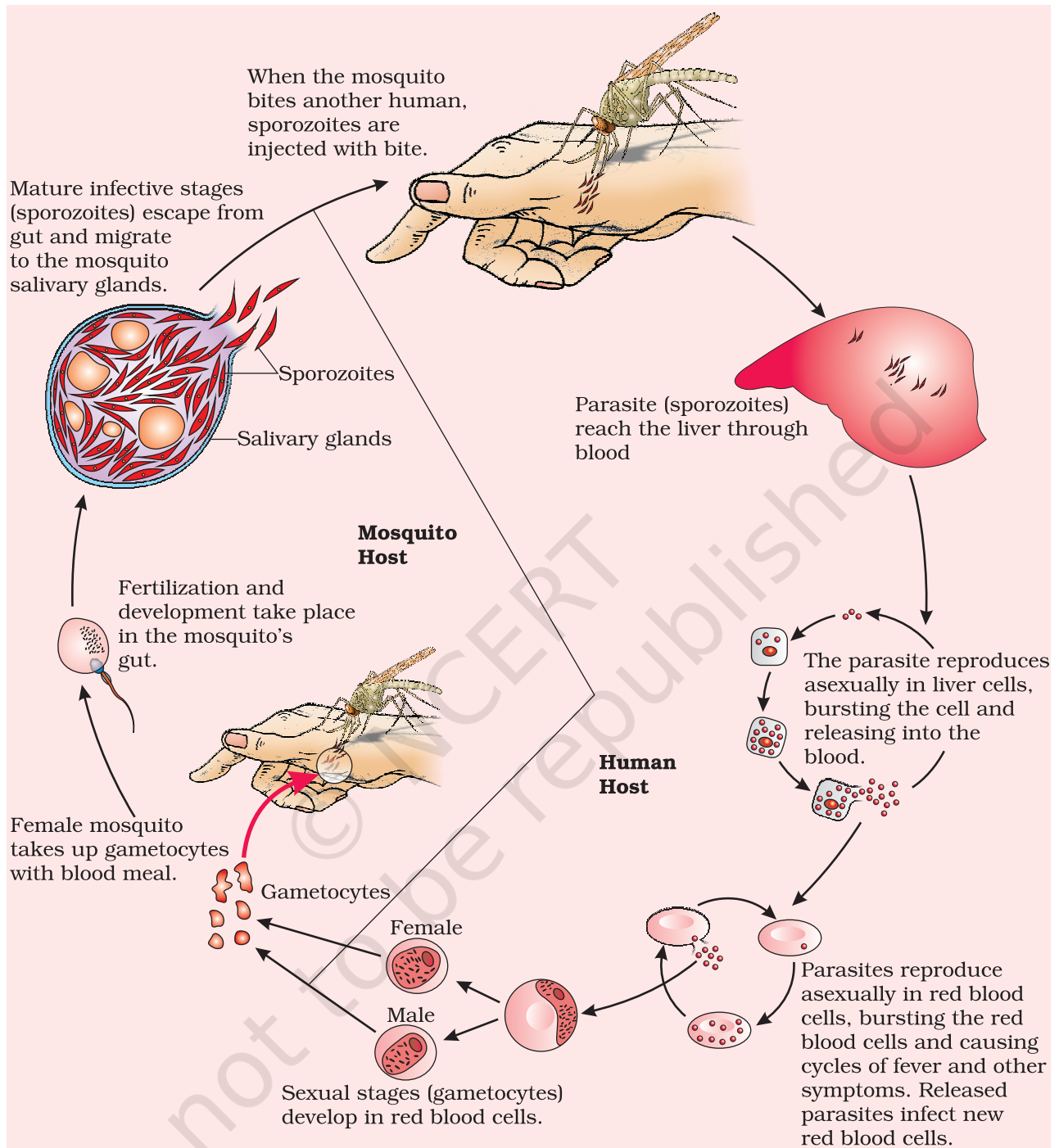
**Widal test** : A classic case in medicine, that of Mary Mallon nicknamed *Typhoid Mary*, is worth mentioning here. She was a cook by profession and was a typhoid carrier who continued to spread typhoid for several years through the food she prepared.

Bacteria like *Streptococcus pneumoniae* and *Haemophilus influenzae* are responsible for the disease **pneumonia** in humans which infects the alveoli (air filled sacs) of the lungs. As a result of the infection, the alveoli get filled with fluid leading to severe problems in respiration. The symptoms of pneumonia include fever, chills, cough and headache. In severe cases, the lips and finger nails may turn gray to bluish in colour. A healthy person acquires the infection by inhaling the droplets/aerosols released by an infected person or even by sharing glasses and utensils with an infected person. Dysentery, plague, diphtheria, etc., are some of the other bacterial diseases in man.

Many viruses also cause diseases in human beings. Rhino viruses represent one such group of viruses which cause one of the most infectious human ailments – the **common cold**. They infect the nose and respiratory passage but not the lungs. The common cold is characterised by nasal congestion and discharge, sore throat, hoarseness, cough, headache, tiredness, etc., which usually last for 3-7 days. Droplets resulting from cough or sneezes of an infected person are either inhaled directly or transmitted through contaminated objects such as pens, books, cups, doorknobs, computer keyboard or mouse, etc., and cause infection in a healthy person.

Some of the human diseases are caused by protozoans too. You might have heard about **malaria**, a disease man has been fighting since many years. *Plasmodium*, a tiny protozoan is responsible for this disease. Different species of *Plasmodium* (*P. vivax*, *P. malaria* and *P. falciparum*) are responsible for different types of malaria. Of these, malignant malaria caused by *Plasmodium falciparum* is the most serious one and can even be fatal.

Let us take a glance at the life cycle of *Plasmodium* (Figure 7.1). *Plasmodium* enters the human body as sporozoites (infectious form) through the bite of infected female *Anopheles* mosquito. The parasites initially multiply within the liver cells and then attack the red blood cells (RBCs) resulting in their rupture. The rupture of RBCs is associated with release of a toxic substance, haemozoin, which is responsible for the chill and high fever recurring every three to four days. When a female *Anopheles* mosquito bites an infected person, these parasites enter the mosquito's body and undergo further development. The parasites multiply within them to form sporozoites that are stored in their salivary glands. When these mosquitoes bite a human, the sporozoites are introduced into his/her body, thereby initiating the events mentioned above. It is interesting to note that the malarial parasite requires two hosts – human and mosquitoes – to complete its life cycle (Figure 7.1); the female *Anopheles* mosquito is the vector (transmitting agent) too.



**Figure 7.1** Stages in the life cycle of *Plasmodium*

*Entamoeba histolytica* is a protozoan parasite in the large intestine of human which causes **amoebiasis (amoebic dysentery)**. Symptoms of this disease include constipation, abdominal pain and cramps, stools with excess mucous and blood clots. Houseflies act as mechanical carriers and serve to transmit the parasite from faeces of infected person to food





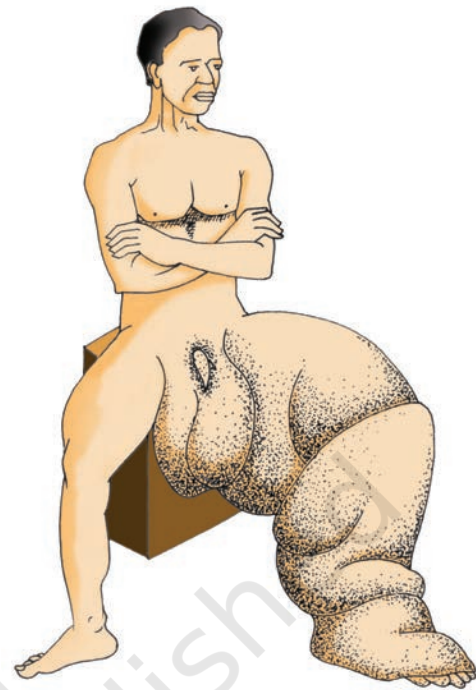
and food products, thereby contaminating them. Drinking water and food contaminated by the faecal matter are the main source of infection.

*Ascaris*, the common round worm and *Wuchereria*, the filarial worm, are some of the helminths which are known to be pathogenic to man. *Ascaris*, an intestinal parasite causes **ascariasis**. Symptoms of these disease include internal bleeding, muscular pain, fever, anemia and blockage of the intestinal passage. The eggs of the parasite are excreted along with the faeces of infected persons which contaminate soil, water, plants, etc. A healthy person acquires this infection through contaminated water, vegetables, fruits, etc.

*Wuchereria* (*W. bancrofti* and *W. malayi*), the filarial worms cause a slowly developing chronic inflammation of the organs in which they live for many years, usually the lymphatic vessels of the lower limbs and the disease is called **elephantiasis** or **filariasis** (Figure 7.2). The genital organs are also often affected, resulting in gross deformities. The pathogens are transmitted to a healthy person through the bite by the female mosquito vectors.

Many fungi belonging to the genera *Microsporium*, *Trichophyton* and *Epidermophyton* are responsible for **ringworms** which is one of the most common infectious diseases in man. Appearance of dry, scaly lesions on various parts of the body such as skin, nails and scalp (Figure 7.3) are the main symptoms of the disease. These lesions are accompanied by intense itching. Heat and moisture help these fungi to grow, which makes them thrive in skin folds such as those in the groin or between the toes. Ringworms are generally acquired from soil or by using towels, clothes or even the comb of infected individuals.

Maintenance of personal and public hygiene is very important for prevention and control of many infectious diseases. Measures for personal hygiene include keeping the body clean; consumption of clean drinking water, food, vegetables, fruits, etc. Public hygiene includes proper disposal of waste and excreta; periodic cleaning and disinfection of water reservoirs, pools, cesspools and tanks and observing standard practices of hygiene in public catering. These measures are particularly essential where the infectious agents are transmitted through food and water such as typhoid, amoebiasis and ascariasis. In cases of air-borne diseases such as pneumonia and common cold, in addition to the above measures, close



**Figure 7.2** Diagram showing inflammation in one of the lower limbs due to elephantiasis



**Figure 7.3** Diagram showing ringworm affected area of the skin



contact with the infected persons or their belongings should be avoided. For diseases such as malaria and filariasis that are transmitted through insect vectors, the most important measure is to control or eliminate the vectors and their breeding places. This can be achieved by avoiding stagnation of water in and around residential areas, regular cleaning of household coolers, use of mosquito nets, introducing fishes like *Gambusia* in ponds that feed on mosquito larvae, spraying of insecticides in ditches, drainage areas and swamps, etc. In addition, doors and windows should be provided with wire mesh to prevent the entry of mosquitoes. Such precautions have become more important especially in the light of recent widespread incidences of the vector-borne (*Aedes* mosquitoes) diseases like dengue and chikungunya in many parts of India.

The advancements made in biological science have armed us to effectively deal with many infectious diseases. The use of vaccines and immunisation programmes have enabled us to completely eradicate a deadly disease like smallpox. A large number of other infectious diseases like polio, diphtheria, pneumonia and tetanus have been controlled to a large extent by the use of vaccines. Biotechnology (about which you will read more in Chapter 10) is at the verge of making available newer and safer vaccines. Discovery of antibiotics and various other drugs has also enabled us to effectively treat infectious diseases.

## 7.2 IMMUNITY

Everyday we are exposed to large number of infectious agents. However, only a few of these exposures result in disease. Why? This is due to the fact that the body is able to defend itself from most of these foreign agents. This overall ability of the host to fight the disease-causing organisms, conferred by the immune system is called **immunity**.

Immunity is of two types: (i) Innate immunity and (ii) Acquired immunity.

### 7.2.1 Innate Immunity

Innate immunity is non-specific type of defence, that is present at the time of birth. This is accomplished by providing different types of barriers to the entry of the foreign agents into our body. Innate immunity consist of four types of barriers. These are —

- (i) **Physical barriers** : Skin on our body is the main barrier which prevents entry of the micro-organisms. Mucus coating of the epithelium lining the respiratory, gastrointestinal and urogenital tracts also help in trapping microbes entering our body.
- (ii) **Physiological barriers** : Acid in the stomach, saliva in the mouth, tears from eyes—all prevent microbial growth.
- (iii) **Cellular barriers** : Certain types of leukocytes (WBC) of our body like polymorpho-nuclear leukocytes (PMNL-neutrophils) and



monocytes and natural killer (type of lymphocytes) in the blood as well as macrophages in tissues can phagocytose and destroy microbes.

- (iv) **Cytokine barriers** : Virus-infected cells secrete proteins called **interferons** which protect non-infected cells from further viral infection.

### 7.2.2 Acquired Immunity

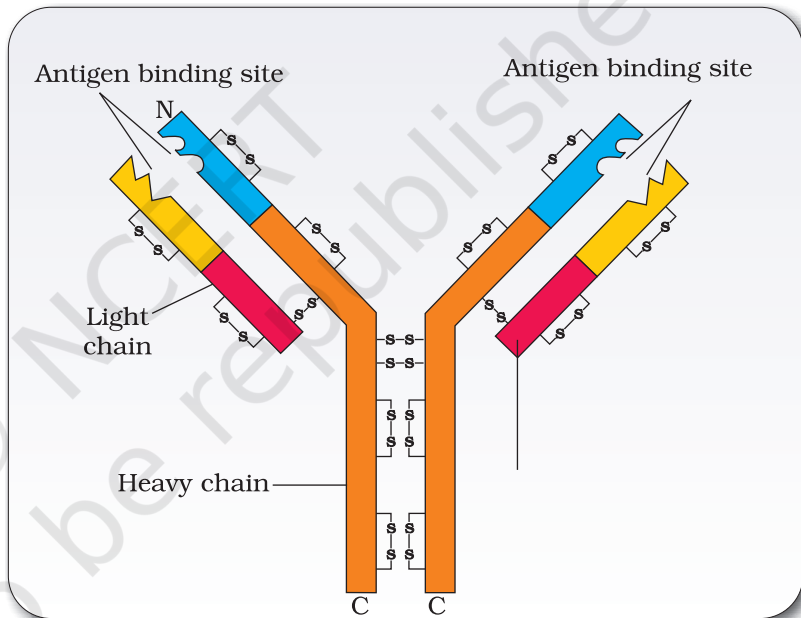
Acquired immunity, on the other hand is pathogen specific. It is characterised by memory. This means when our body encounters a pathogen for the first time it produces a response called **primary response** which is of low intensity. Subsequent encounter with the same pathogen elicits a highly intensified secondary or anamnestic response. This is ascribed to the fact that our body appears to have memory of the first encounter.

The primary and secondary immune responses are carried out with the help of two special types of lymphocytes present in our blood, i.e., **B-lymphocytes** and **T-lymphocytes**.

The B-lymphocytes produce an army of proteins in response to pathogens into our blood to fight with them. These proteins are called antibodies. The T-cells themselves do not secrete antibodies but help B cells to produce them. Each antibody molecule has four peptide chains, two small called **light chains** and two longer called **heavy chains**.

Hence, an antibody is represented

as  $H_2L_2$ . Different types of antibodies are produced in our body. IgA, IgM, IgE, IgG are some of them. A cartoon of an antibody is given in Figure 7.4. Because these antibodies are found in the blood, the response is also called as **humoral immune response**. This is one of the two types of our acquired immune response – antibody mediated. The second type is called cell-mediated immune response or **cell-mediated immunity (CMI)**. The T-lymphocytes mediate CMI. Very often, when some human organs like heart, eye, liver, kidney fail to function satisfactorily, transplantation is the only remedy to enable the patient to live a normal life. Then a search begins – to find a suitable donor. *Why is it that the organs cannot be taken from just anybody? What is it that the doctors check?* Grafts from



**Figure 7.4** Structure of an antibody molecule



just any source – an animal, another primate, or any human beings cannot be made since the grafts would be rejected sooner or later. Tissue matching, blood group matching are essential before undertaking any graft/transplant and even after this the patient has to take immunosuppressants all his/her life. The body is able to differentiate 'self' and 'nonself' and the cell-mediated immune response is responsible for the graft rejection.

### 7.2.3 Active and Passive Immunity

When a host is exposed to antigens, which may be in the form of living or dead microbes or other proteins, antibodies are produced in the host body. This type of immunity is called **active immunity**. Active immunity is slow and takes time to give its full effective response. Injecting the microbes deliberately during immunisation or infectious organisms gaining access into body during natural infection induce active immunity. When ready-made antibodies are directly given to protect the body against foreign agents, it is called **passive immunity**. *Do you know why mother's milk is considered very essential for the newborn infant?* The yellowish fluid **colostrum** secreted by mother during the initial days of lactation has abundant antibodies (IgA) to protect the infant. The foetus also receives some antibodies from their mother, through the placenta during pregnancy. These are some examples of passive immunity.

### 7.2.4 Vaccination and Immunisation

The principle of immunisation or vaccination is based on the property of 'memory' of the immune system. In vaccination, a preparation of antigenic proteins of pathogen or inactivated/weakened pathogen (vaccine) are introduced into the body. The antibodies produced in the body against these antigens would neutralise the pathogenic agents during actual infection. The vaccines also generate memory – B and T-cells that recognise the pathogen quickly on subsequent exposure and overwhelm the invaders with a massive production of antibodies. If a person is infected with some deadly microbes to which quick immune response is required as in tetanus, we need to directly inject the preformed antibodies, or antitoxin (a preparation containing antibodies to the toxin). Even in cases of snakebites, the injection which is given to the patients, contain preformed antibodies against the snake venom. This type of immunisation is called **passive immunisation**.

Recombinant DNA technology has allowed the production of antigenic polypeptides of pathogen in bacteria or yeast. Vaccines produced using this approach allow large scale production and hence greater availability for immunisation, e.g., hepatitis B vaccine produced from yeast.



### 7.2.5 Allergies

When you have gone to a new place and suddenly you started sneezing, wheezing for no explained reason, and when you went away, your symptoms disappeared. Did this happen to you? Some of us are sensitive to some particles in the environment. The above-mentioned reaction could be because of allergy to pollen, mites, etc., which are different in different places.

The exaggerated response of the immune system to certain antigens present in the environment is called **allergy**. The substances to which such an immune response is produced are called allergens. The antibodies produced to these are of IgE type. Common examples of allergens are mites in dust, pollens, animal dander, etc. Symptoms of allergic reactions include sneezing, watery eyes, running nose and difficulty in breathing. Allergy is due to the release of chemicals like histamine and serotonin from the mast cells. For determining the cause of allergy, the patient is exposed to or injected with very small doses of possible allergens, and the reactions studied. The use of drugs like anti-histamine, adrenalin and steroids quickly reduce the symptoms of allergy. Somehow, modern-day life style has resulted in lowering of immunity and more sensitivity to allergens – more and more children in metro cities of India suffer from allergies and asthma due to sensitivity to the environment. This could be because of the protected environment provided early in life.

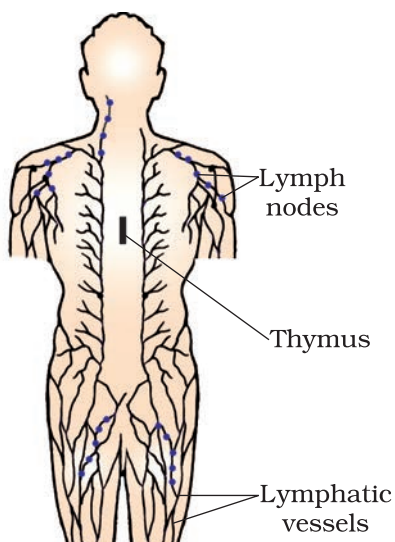
### 7.2.6 Auto Immunity

Memory-based acquired immunity evolved in higher vertebrates based on the ability to differentiate foreign organisms (e.g., pathogens) from self-cells. While we still do not understand the basis of this, two corollaries of this ability have to be understood. One, higher vertebrates can distinguish foreign molecules as well as foreign organisms. Most of the experimental immunology deals with this aspect. Two, sometimes, due to genetic and other unknown reasons, the body attacks self-cells. This results in damage to the body and is called **auto-immune** disease. Rheumatoid arthritis which affects many people in our society is an auto-immune disease.

### 7.2.7 Immune System in the Body

The human immune system consists of lymphoid organs, tissues, cells and soluble molecules like antibodies. As you have read, immune system is unique in the sense that it recognises foreign antigens, responds to these and remembers them. The immune system also plays an important role in allergic reactions, auto-immune diseases and organ transplantation.

**Lymphoid organs:** These are the organs where origin and/or maturation and proliferation of lymphocytes occur. The primary lymphoid organs are **bone marrow** and **thymus** where immature lymphocytes differentiate



**Figure 7.5** Diagrammatic representation of Lymph nodes

into antigen-sensitive lymphocytes. After maturation the lymphocytes migrate to secondary lymphoid organs like spleen, lymph nodes, tonsils, Peyer's patches of small intestine and appendix. The secondary lymphoid organs provide the sites for interaction of lymphocytes with the antigen, which then proliferate to become effector cells. The location of various lymphoid organs in the human body is shown in Figure 7.5.

The bone marrow is the main lymphoid organ where all blood cells including lymphocytes are produced. The thymus is a lobed organ located near the heart and beneath the breastbone. The thymus is quite large at the time of birth but keeps reducing in size with age and by the time puberty is attained it reduces to a very small size. Both bone-marrow and thymus provide micro-environments for the development and maturation of T-lymphocytes. The spleen is a large bean-shaped organ. It mainly contains lymphocytes and phagocytes. It acts as a filter of the blood by trapping blood-borne micro-organisms. Spleen also has a large reservoir of erythrocytes. The lymph nodes are small solid structures located at different

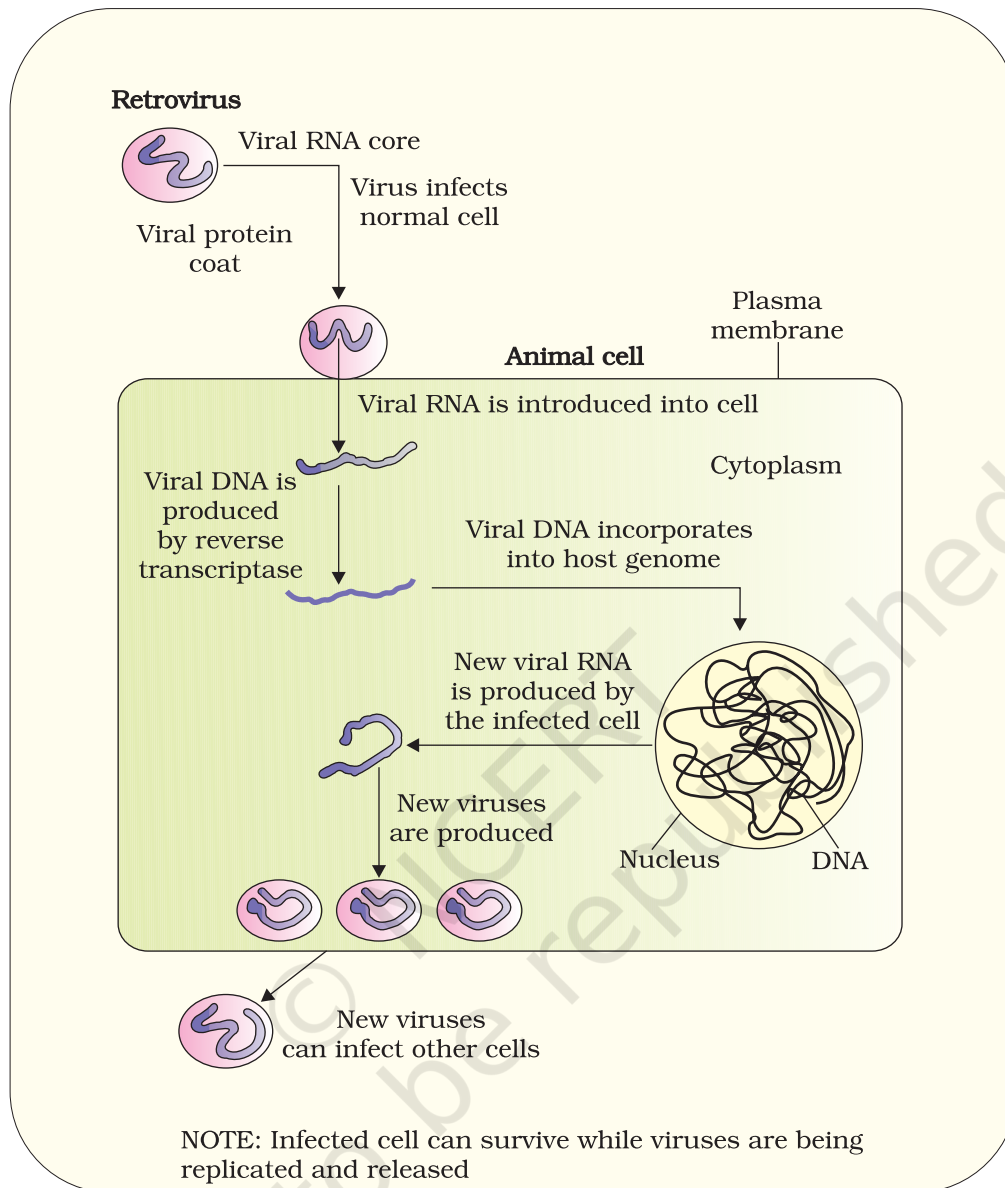
points along the lymphatic system. Lymph nodes serve to trap the micro-organisms or other antigens, which happen to get into the lymph and tissue fluid. Antigens trapped in the lymph nodes are responsible for the activation of lymphocytes present there and cause the immune response.

There is lymphoid tissue also located within the lining of the major tracts (respiratory, digestive and urogenital tracts) called **mucosa-associated lymphoid tissue (MALT)**. It constitutes about 50 per cent of the lymphoid tissue in human body.

### 7.3 AIDS

The word AIDS stands for **Acquired Immuno Deficiency Syndrome**. This means deficiency of immune system, acquired during the lifetime of an individual indicating that it is not a congenital disease. 'Syndrome' means a group of symptoms. AIDS was first reported in 1981 and in the last twenty-five years or so, it has spread all over the world killing more than 25 million persons.

AIDS is caused by the Human Immuno deficiency Virus (HIV), a member of a group of viruses called **retrovirus**, which have an envelope enclosing the RNA genome (Figure 7.6). Transmission of HIV-infection generally occurs by (a) sexual contact with infected person, (b) by transfusion of contaminated blood and blood products, (c) by sharing infected needles as in the case of intravenous drug abusers and (d) from infected mother to her child through placenta. So, people who are at high risk of getting this infection includes - individuals who have multiple



**Figure 7.6** Replication of retrovirus

sexual partners, drug addicts who take drugs intravenously, individuals who require repeated blood transfusions and children born to an HIV infected mother. *Do you know—when do people need repeated blood transfusion? Find out and make a list of such conditions.* It is important to note that HIV/AIDS is not spread by mere touch or physical contact; it spreads only through body fluids. It is, hence, imperative, for the physical and psychological well-being, that the HIV/AIDS infected persons are not isolated from family and society. There is always a time-lag between the infection and appearance of AIDS symptoms. This period may vary from a few months to many years (usually 5-10 years).



After getting into the body of the person, the virus enters into macrophages where RNA genome of the virus replicates to form viral DNA with the help of the enzyme reverse transcriptase. This viral DNA gets incorporated into host cell's DNA and directs the infected cells to produce virus particles (Figure 7.6). The macrophages continue to produce virus and in this way acts like a HIV factory. Simultaneously, HIV enters into helper T-lymphocytes ( $T_H$ ), replicates and produce progeny viruses. The progeny viruses released in the blood attack other helper T-lymphocytes. This is repeated leading to a progressive decrease in the number of helper T-lymphocytes in the body of the infected person. During this period, the person suffers from bouts of fever, diarrhoea and weight loss. Due to decrease in the number of helper T lymphocytes, the person starts suffering from infections that could have been otherwise overcome such as those due to bacteria especially *Mycobacterium*, viruses, fungi and even parasites like *Toxoplasma*. The patient becomes so immuno-deficient that he/she is unable to protect himself/herself against these infections. A widely used diagnostic test for AIDS is **enzyme linked immuno-sorbent assay (ELISA)**. Treatment of AIDS with anti-retroviral drugs is only partially effective. They can only prolong the life of the patient but cannot prevent death, which is inevitable.

**Prevention of AIDS :** As AIDS has no cure, prevention is the best option. Moreover, HIV infection, more often, spreads due to conscious behaviour patterns and is not something that happens inadvertently, like pneumonia or typhoid. Of course, infection in blood transfusion patients, new-borns (from mother) etc., may take place due to poor monitoring. The only excuse may be ignorance and it has been rightly said – “don't die of ignorance”. In our country the National AIDS Control Organisation (NACO) and other non-governmental organisation (NGOs) are doing a lot to educate people about AIDS. WHO has started a number of programmes to prevent the spreading of HIV infection. Making blood (from blood banks) safe from HIV, ensuring the use of only disposable needles and syringes in public and private hospitals and clinics, free distribution of condoms, controlling drug abuse, advocating safe sex and promoting regular check-ups for HIV in susceptible populations, are some such steps taken up.

Infection with HIV or having AIDS is something that should not be hidden – since then, the infection may spread to many more people. HIV/AIDS-infected people need help and sympathy instead of being shunned by society. Unless society recognises it as a problem to be dealt with in a collective manner – the chances of wider spread of the disease increase manifold. It is a malady that can only be tackled, by the society and medical fraternity acting together, to prevent the spread of the disease.

## 7.4 CANCER

**Cancer** is one of the most dreaded diseases of human beings and is a major cause of death all over the globe. More than a million Indians suffer from





cancer and a large number of them die from it annually. The mechanisms that underlie development of cancer or oncogenic transformation of cells, its treatment and control have been some of the most intense areas of research in biology and medicine.

In our body, cell growth and differentiation is highly controlled and regulated. In cancer cells, there is breakdown of these regulatory mechanisms. Normal cells show a property called **contact inhibition** by virtue of which contact with other cells inhibits their uncontrolled growth. Cancer cells appear to have lost this property. As a result of this, cancerous cells just continue to divide giving rise to masses of cells called **tumors**. Tumors are of two types: benign and malignant. **Benign tumors** normally remain confined to their original location and do not spread to other parts of the body and cause little damage. The **malignant tumors**, on the other hand are a mass of proliferating cells called neoplastic or tumor cells. These cells grow very rapidly, invading and damaging the surrounding normal tissues. As these cells actively divide and grow they also starve the normal cells by competing for vital nutrients. Cells sloughed from such tumors reach distant sites through blood, and wherever they get lodged in the body, they start a new tumor there. This property called **metastasis** is the most feared property of malignant tumors.

**Causes of cancer :** Transformation of normal cells into cancerous neoplastic cells may be induced by physical, chemical or biological agents. These agents are called **carcinogens**. Ionising radiations like X-rays and gamma rays and non-ionizing radiations like UV cause DNA damage leading to neoplastic transformation. The chemical carcinogens present in tobacco smoke have been identified as a major cause of lung cancer. Cancer causing viruses called **oncogenic viruses** have genes called **viral oncogenes**. Furthermore, several genes called **cellular oncogenes** (*c-onc*) or **proto oncogenes** have been identified in normal cells which, when activated under certain conditions, could lead to oncogenic transformation of the cells.

**Cancer detection and diagnosis :** Early detection of cancers is essential as it allows the disease to be treated successfully in many cases. Cancer detection is based on biopsy and histopathological studies of the tissue and blood and bone marrow tests for increased cell counts in the case of leukemias. In biopsy, a piece of the suspected tissue cut into thin sections is stained and examined under microscope (histopathological studies) by a pathologist. Techniques like radiography (use of X-rays), CT (computed tomography) and MRI (magnetic resonance imaging) are very useful to detect cancers of the internal organs. Computed tomography uses X-rays to generate a three-dimensional image of the internals of an object. MRI uses strong magnetic fields and non-ionising radiations to accurately detect pathological and physiological changes in the living tissue.

Antibodies against cancer-specific antigens are also used for detection of certain cancers. Techniques of molecular biology can be

applied to detect genes in individuals with inherited susceptibility to certain cancers. Identification of such genes, which predispose an individual to certain cancers, may be very helpful in prevention of cancers. Such individuals may be advised to avoid exposure to particular carcinogens to which they are susceptible (e.g., tobacco smoke in case of lung cancer).

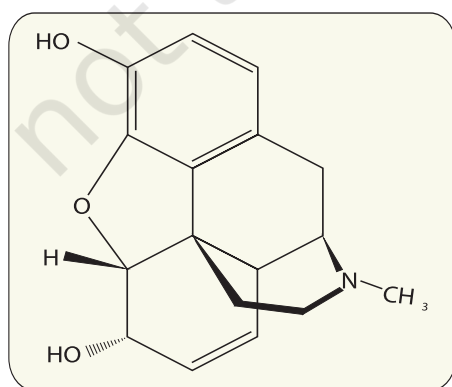
**Treatment of cancer :** The common approaches for treatment of cancer are surgery, radiation therapy and immunotherapy. In radiotherapy, tumor cells are irradiated lethally, taking proper care of the normal tissues surrounding the tumor mass. Several chemotherapeutic drugs are used to kill cancerous cells. Some of these are specific for particular tumors. Majority of drugs have side effects like hair loss, anemia, etc. Most cancers are treated by combination of surgery, radiotherapy and chemotherapy. Tumor cells have been shown to avoid detection and destruction by immune system. Therefore, the patients are given substances called biological response modifiers such as  $\alpha$ -interferon which activates their immune system and helps in destroying the tumor.

## 7.5 DRUGS AND ALCOHOL ABUSE

Surveys and statistics show that use of drugs and alcohol has been on the rise especially among the youth. This is really a cause of concern as it could result in many harmful effects. Proper education and guidance would enable youth to safeguard themselves against these dangerous behaviour patterns and follow healthy lifestyles.

The drugs, which are commonly abused are opioids, cannabinoids and coca alkaloids. Majority of these are obtained from flowering plants. Some are obtained from fungi.

**Opioids** are the drugs, which bind to specific opioid receptors present in our central nervous system and gastrointestinal tract. Heroin (Figure 7.7), commonly called *smack* is chemically diacetylmorphine which is a white, odourless, bitter crystalline compound. This is obtained by acetylation of morphine (Figure 7.7), which is extracted from the latex of



**Figure 7.7** Chemical structure of Morphine

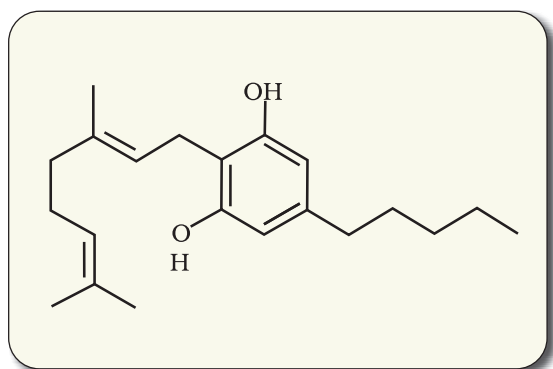


**Figure 7.8** Opium poppy



poppy plant *Papaver somniferum* (Figure 7.8). Generally taken by snorting and injection, heroin is a depressant and slows down body functions.

**Cannabinoids** are a group of chemicals (Figure 7.9), which interact with cannabinoid receptors present principally in the brain. Natural cannabinoids are obtained from the inflorescences of the plant *Cannabis sativa* (Figure 7.10). The flower tops, leaves and the resin of cannabis plant are used in various combinations to produce marijuana, hashish, charas and ganja. Generally taken by inhalation and oral ingestion, these are known for their effects on cardiovascular system of the body.



**Figure 7.9** Skeletal structure of cannabinoid molecule



**Figure 7.10** Leaves of *Cannabis sativa*

Coca alkaloid or **cocaine** is obtained from coca plant *Erythroxylum coca*, native to South America. It interferes with the transport of the neuro-transmitter dopamine. Cocaine, commonly called **coke** or **crack** is usually snorted. It has a potent stimulating action on central nervous system, producing a sense of euphoria and increased energy. Excessive dosage of cocaine causes hallucinations. Other well-known plants with hallucinogenic properties are *Atropa belladonna* and *Datura* (Figure 7.11). These days cannabinoids are also being abused by some sportspersons.

Drugs like barbiturates, amphetamines, benzodiazepines, and other similar drugs, that are normally used as medicines to help patients cope with mental illnesses like depression and insomnia, are often abused. Morphine is a very effective sedative and painkiller, and is very useful in patients who have undergone surgery. Several plants, fruits and seeds having hallucinogenic properties have been used for hundreds of years in folk-medicine, religious ceremonies and rituals all over the globe. When these are taken for a purpose other than medicinal use or in amounts/frequency that impairs one's physical, physiological or psychological functions, it constitutes drug abuse.



**Figure 7.11** Flowering branch of *Datura*



Smoking also paves the way to hard drugs. Tobacco has been used by human beings for more than 400 years. It is smoked, chewed or used as a snuff. Tobacco contains a large number of chemical substances including nicotine, an alkaloid. Nicotine stimulates adrenal gland to release adrenaline and nor-adrenaline into blood circulation, both of which raise blood pressure and increase heart rate. Smoking is associated with increased incidence of cancers of lung, urinary bladder and throat, bronchitis, emphysema, coronary heart disease, gastric ulcer, etc. Tobacco chewing is associated with increased risk of cancer of the oral cavity. Smoking increases carbon monoxide (CO) content in blood and reduces the concentration of haembound oxygen. This causes oxygen deficiency in the body.

When one buys packets of cigarettes one cannot miss the statutory warning that is present on the packing which warns against smoking and says how it is injurious to health. Yet, smoking is very prevalent in society, both among young and old. Knowing the dangers of smoking and chewing tobacco, and its addictive nature, the youth and old need to avoid these habits. Any addict requires counselling and medical help to get rid of the habit.

### 7.5.1 Adolescence and Drug/Alcohol Abuse

Adolescence means both 'a period' and 'a process' during which a child becomes mature in terms of his/her attitudes and beliefs for effective participation in society. The period between 12-18 years of age may be thought of as adolescence period. In other words, adolescence is a bridge linking childhood and adulthood. Adolescence is accompanied by several biological and behavioural changes. Adolescence, thus is a very vulnerable phase of mental and psychological development of an individual.

Curiosity, need for adventure and excitement, and experimentation, constitute common causes, which motivate youngsters towards drug and alcohol use. A child's natural curiosity motivates him/her to experiment. This is complicated further by effects that might be perceived as benefits, of alcohol or drug use. Thus, the first use of drugs or alcohol may be out of curiosity or experimentation, but later the child starts using these to escape facing problems. Of late, stress, from pressures to excel in academics or examinations, has played a significant role in persuading the youngsters to try alcohol and drugs. The perception among youth that it is 'cool' or progressive to smoke, use drugs or alcohol, is also in a way a major cause for youth to start these habits. Television, movies, newspapers, internet also help to promote this perception. Other factors that have been seen to be associated with drug and alcohol abuse among adolescents are unstable or unsupportive family structures and peer pressure.



### 7.5.2 Addiction and Dependence

Because of the perceived benefits, drugs are frequently used repeatedly. The most important thing, which one fails to realise, is the inherent addictive nature of alcohol and drugs. Addiction is a psychological attachment to certain effects – such as euphoria and a temporary feeling of well-being – associated with drugs and alcohol. These drive people to take them even when these are not needed, or even when their use becomes self-destructive. With repeated use of drugs, the tolerance level of the receptors present in our body increases. Consequently the receptors respond only to higher doses of drugs or alcohol leading to greater intake and addiction. However, it should be clearly borne in mind that use of these drugs even once, can be a fore-runner to addiction. Thus, the addictive potential of drugs and alcohol, pull the user into a vicious circle leading to their regular use (abuse) from which he/she may not be able to get out. In the absence of any guidance or counselling, the person gets addicted and becomes dependent on their use.

Dependence is the tendency of the body to manifest a characteristic and unpleasant **withdrawal syndrome** if regular dose of drugs/alcohol is abruptly discontinued. This is characterised by anxiety, shakiness, nausea and sweating, which may be relieved when use is resumed again. In some cases, withdrawal symptoms can be severe and even life threatening and the person may need medical supervision.

Dependence leads the patient to ignore all social norms in order to get sufficient funds to satiate his/her needs. These result in many social adjustment problems.

### 7.5.3 Effects of Drug/Alcohol Abuse

The immediate adverse effects of drugs and alcohol abuse are manifested in the form of reckless behaviour, vandalism and violence. Excessive doses of drugs may lead to coma and death due to respiratory failure, heart failure or cerebral hemorrhage. A combination of drugs or their intake along with alcohol generally results in overdosing and even deaths. The most common warning signs of drug and alcohol abuse among youth include drop in academic performance, unexplained absence from school/college, lack of interest in personal hygiene, withdrawal, isolation, depression, fatigue, aggressive and rebellious behaviour, deteriorating relationships with family and friends, loss of interest in hobbies, change in sleeping and eating habits, fluctuations in weight, appetite, etc.

There may even be some far-reaching implications of drug/alcohol abuse. If an abuser is unable to get money to buy drugs/alcohol he/she may turn to stealing. The adverse effects are just not restricted to the person who is using drugs or alcohol. At times, a drug/alcohol addict becomes the cause of mental and financial distress to his/her entire family and friends.



Those who take drugs intravenously (direct injection into the vein using a needle and syringe), are much more likely to acquire serious infections like AIDS and Hepatitis B. The viruses, which are responsible for these diseases, are transferred from one person to another by sharing of infected needles and syringes. Both AIDS and Hepatitis B infections are chronic infections and ultimately fatal. Both can be transmitted through sexual contact or infected blood.

The use of alcohol during adolescence may also have long-term effects. It could lead to heavy drinking in adulthood. The chronic use of drugs and alcohol damages nervous system and liver (**cirrhosis**). The use of drugs and alcohol during pregnancy is also known to adversely affect the foetus.

Another misuse of drugs is what certain sportspersons do to enhance their performance. They (mis)use narcotic analgesics, anabolic steroids, diuretics and certain hormones in sports to increase muscle strength and bulk and to promote aggressiveness and as a result increase athletic performance. The side-effects of the use of anabolic steroids in females include masculinisation (features like males), increased aggressiveness, mood swings, depression, abnormal menstrual cycles, excessive hair growth on the face and body, enlargement of clitoris, deepening of voice. In males it includes acne, increased aggressiveness, mood swings, depression, reduction of size of the testicles, decreased sperm production, potential for kidney and liver dysfunction, breast enlargement, premature baldness, enlargement of the prostate gland. These effects may be permanent with prolonged use. In the adolescent male or female, severe facial and body acne, and premature closure of the growth centres of the long bones may result in stunted growth.

#### 7.5.4 Prevention and Control

The age-old adage of 'prevention is better than cure' holds true here also. It is also true that habits such as smoking, taking drug or alcohol are more likely to be taken up at a young age, more during adolescence. Hence, it is best to identify the situations that may push an adolescent towards use of drugs or alcohol, and to take remedial measures well in time. In this regard, the parents and the teachers have a special responsibility. Parenting that combines with high levels of nurturance and consistent discipline, has been associated with lowered risk of substance (alcohol/drugs/tobacco) abuse. Some of the measures mentioned here would be particularly useful for prevention and control of alcohol and drugs abuse among adolescents

- (i) **Avoid undue peer pressure** - Every child has his/her own choice and personality, which should be respected and nurtured. A child should not be pushed unduly to perform beyond his/her threshold limits; be it studies, sports or other activities.




- (ii) **Education and counselling** - Educating and counselling him/her to face problems and stresses, and to accept disappointments and failures as a part of life. It would also be worthwhile to channelise the child's energy into healthy pursuits like sports, reading, music, yoga and other extracurricular activities.
- (iii) **Seeking help from parents and peers** - Help from parents and peers should be sought immediately so that they can guide appropriately. Help may even be sought from close and trusted friends. Besides getting proper advice to sort out their problems, this would help young to vent their feelings of anxiety and guilt.
- (iv) **Looking for danger signs** - Alert parents and teachers need to look for and identify the danger signs discussed above. Even friends, if they find someone using drugs or alcohol, should not hesitate to bring this to the notice of parents or teacher in the best interests of the person concerned. Appropriate measures would then be required to diagnose the malady and the underlying causes. This would help in initiating proper remedial steps or treatment.
- (v) **Seeking professional and medical help** - A lot of help is available in the form of highly qualified psychologists, psychiatrists, and de-addiction and rehabilitation programmes to help individuals who have unfortunately got in the quagmire of drug/alcohol abuse. With such help, the affected individual with sufficient efforts and will power, can get rid of the problem completely and lead a perfectly normal and healthy life.

### SUMMARY

Health is not just the absence of disease. It is a state of complete physical, mental, social and psychological well-being. Diseases like typhoid, cholera, pneumonia, fungal infections of skin, malaria and many others are a major cause of distress to human beings. Vector-borne diseases like malaria especially one caused by *Plasmodium falciparum*, if not treated, may prove fatal. Besides personal cleanliness and hygiene, public health measures like proper disposal of waste, decontamination of drinking water, control of vectors like mosquitoes and immunisation are very helpful in preventing these diseases. Our immune system plays the major role in preventing these diseases when we are exposed to disease-causing agents. The innate defences of our body like skin, mucous membranes, antimicrobial substances present in our tears, saliva and the phagocytic cells help to block the entry of pathogens into our body. If the pathogens succeed in gaining entry to our body, specific antibodies (humoral immune response) and cells (cell mediated immune response) serve to kill these pathogens. Immune system has memory. On subsequent exposure to same pathogen, the immune response is rapid and more intense. This forms the basis of protection





afforded by vaccination and immunisation. Among other diseases, AIDS and cancer kill a large number of individuals worldwide. AIDS caused by the human immuno-deficiency virus (HIV) is fatal but can be prevented if certain precautions are taken. Many cancers are curable if detected early and appropriate therapeutic measures are taken. Of late, drug and alcohol abuse among youth and adolescents is becoming another cause of concern. Because of the addictive nature of alcohol and drugs, and their perceived benefits like relief from stress, a person may try taking these in the face of peer pressure, examinations-related and competition-related stresses. In doing so, he/she may get addicted to them. Education about their harmful effects, counselling and seeking immediate professional and medical help would totally relieve the individual from these evils.

## EXERCISES

1. What are the various public health measures, which you would suggest as safeguard against infectious diseases?
2. In which way has the study of biology helped us to control infectious diseases?
3. How does the transmission of each of the following diseases take place?  
(a) Amoebiasis (b) Malaria (c) Ascariasis (d) Pneumonia
4. What measure would you take to prevent water-borne diseases?
5. Discuss with your teacher what does 'a suitable gene' means, in the context of DNA vaccines.
6. Name the primary and secondary lymphoid organs.
7. The following are some well-known abbreviations, which have been used in this chapter. Expand each one to its full form:  
(a) MALT (b) CMI (c) AIDS (d) NACO  
(e) HIV
8. Differentiate the following and give examples of each:  
(a) Innate and acquired immunity (b) Active and passive immunity
9. Draw a well-labelled diagram of an antibody molecule.
10. What are the various routes by which transmission of human immuno-deficiency virus takes place?
11. What is the mechanism by which the AIDS virus causes deficiency of immune system of the infected person?
12. How is a cancerous cell different from a normal cell?
13. Explain what is meant by metastasis.
14. List the harmful effects caused by alcohol/drug abuse.
15. Do you think that friends can influence one to take alcohol/drugs? If yes, how may one protect himself/herself from such an influence?
16. Why is that once a person starts taking alcohol or drugs, it is difficult to get rid of this habit? Discuss it with your teacher.
17. In your view what motivates youngsters to take to alcohol or drugs and how can this be avoided?



# CHAPTER 8

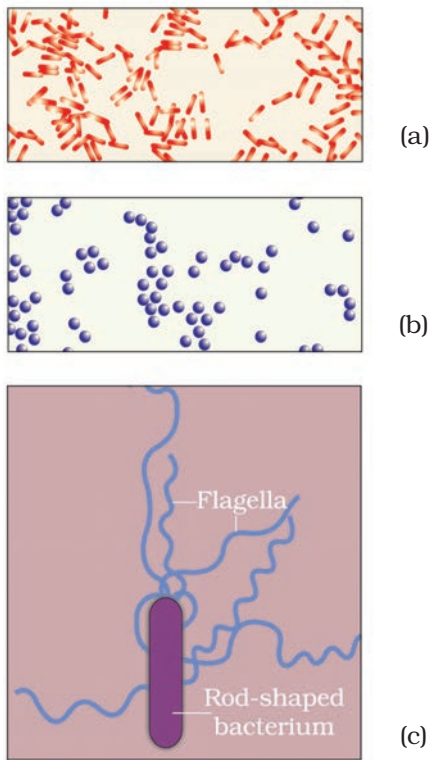


# MICROBES IN HUMAN WELFARE

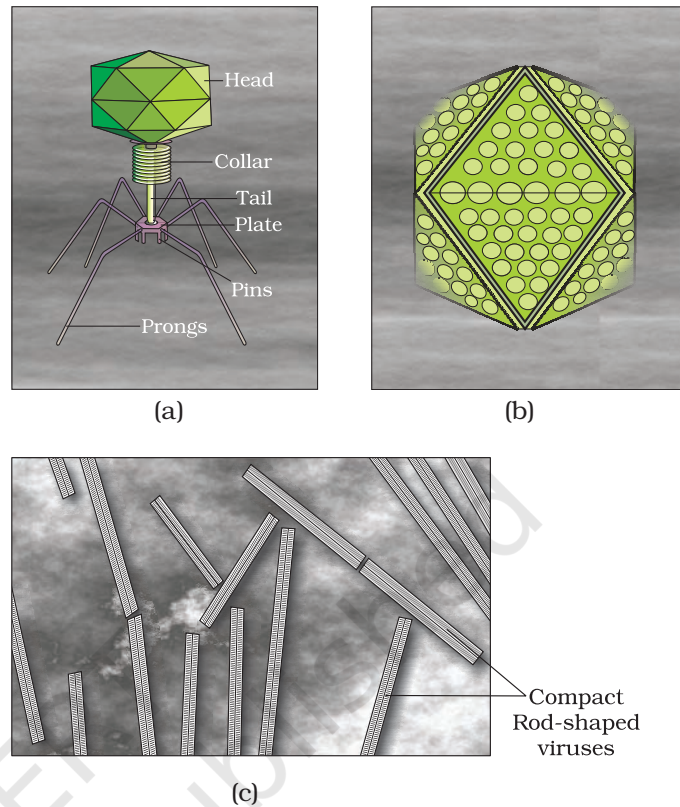
- 8.1 *Microbes in Household Products*
- 8.2 *Microbes in Industrial Products*
- 8.3 *Microbes in Sewage Treatment*
- 8.4 *Microbes in Production of Biogas*
- 8.5 *Microbes as Biocontrol Agents*
- 8.6 *Microbes as Biofertilisers*

Besides macroscopic plants and animals, microbes are the major components of biological systems on this earth. You have studied about the diversity of living organisms in Class XI. *Do you remember which Kingdoms among the living organisms contain micro-organisms? Which are the ones that are only microscopic?* Microbes are present everywhere – in soil, water, air, inside our bodies and that of other animals and plants. They are present even at sites where no other life-form could possibly exist – sites such as deep inside the geysers (thermal vents) where the temperature may be as high as 100°C, deep in the soil, under the layers of snow several metres thick, and in highly acidic environments. Microbes are diverse – protozoa, bacteria, fungi and microscopic animal and plant viruses, viroids and also prions that are proteinacious infectious agents. Some of the microbes are shown in Figures 8.1 and 8.2.

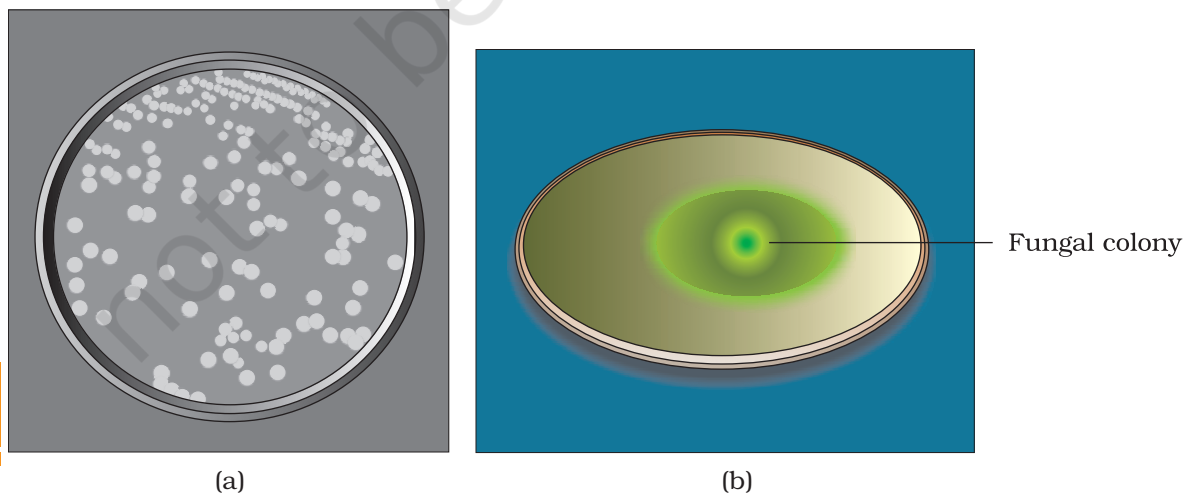
Microbes like bacteria and many fungi can be grown on nutritive media to form colonies (Figure 8.3), that can be seen with the naked eyes. Such cultures are useful in studies on micro-organisms.



**Figure 8.1** Bacteria: (a) Rod-shaped, magnified 1500X; (b) Spherical shaped, magnified 1500X; (c) A rod-shaped bacterium showing flagella, magnified 50,000X



**Figure 8.2** Viruses: (a) A bacteriophage; (b) Adenovirus which causes respiratory infections; (c) Rod-shaped Tobacco Mosaic Virus (TMV). Magnified about 1,00,000–1,50,000X



**Figure 8.3** (a) Colonies of bacteria growing in a petri dish; (b) Fungal colony growing in a petri dish



In chapter 7, you have read that microbes cause a large number of diseases in human beings. They also cause diseases in animals and plants. But this should not make you think that all microbes are harmful; several microbes are useful to man in diverse ways. Some of the most important contributions of microbes to human welfare are discussed in this chapter.

## 8.1 MICROBES IN HOUSEHOLD PRODUCTS

You would be surprised to know that we use microbes or products derived from them everyday. A common example is the production of curd from milk. Micro-organisms such as *Lactobacillus* and others commonly called **lactic acid bacteria (LAB)** grow in milk and convert it to curd. During growth, the LAB produce acids that coagulate and partially digest the milk proteins. A small amount of curd added to the fresh milk as inoculum or starter contain millions of LAB, which at suitable temperatures multiply, thus converting milk to curd, which also improves its nutritional quality by increasing vitamin B<sub>12</sub>. In our stomach too, the LAB play very beneficial role in checking disease-causing microbes.

The dough, which is used for making foods such as *dosa* and *idli* is also fermented by bacteria. The puffed-up appearance of dough is due to the production of CO<sub>2</sub> gas. *Can you tell which metabolic pathway is taking place resulting in the formation of CO<sub>2</sub>? Where do you think the bacteria for these fermentations come from?* Similarly the dough, which is used for making bread, is fermented using baker's yeast (*Saccharomyces cerevisiae*). A number of traditional drinks and foods are also made by fermentation by the microbes. 'Toddy', a traditional drink of some parts of southern India is made by fermenting sap from palms. Microbes are also used to ferment fish, soyabean and bamboo-shoots to make foods. Cheese, is one of the oldest food items in which microbes were used. Different varieties of cheese are known by their characteristic texture, flavour and taste, the specificity coming from the microbes used. For example, the large holes in 'Swiss cheese' are due to production of a large amount of CO<sub>2</sub> by a bacterium named *Propionibacterium sharmanii*. The 'Roquefort cheese' are ripened by growing a specific fungi on them, which gives them a particular flavour.

## 8.2 MICROBES IN INDUSTRIAL PRODUCTS

Even in industry, microbes are used to synthesise a number of products valuable to human beings. Beverages and antibiotics are some examples. Production on an industrial scale, requires growing microbes in very large vessels called **fermentors** (Figure 8.4).



**Figure 8.4** Fermentors



**Figure 8.5** Fermentation Plant

### 8.2.1 Fermented Beverages

Microbes especially yeasts have been used from time immemorial for the production of beverages like wine, beer, whisky, brandy or rum. For this purpose the same yeast *Saccharomyces cerevisiae* used for bread-making and commonly called brewer's yeast, is used for fermenting malted cereals and fruit juices, to produce ethanol. *Do you recollect the metabolic reactions, which result in the production of ethanol by yeast?* Depending on the type of the raw material used for fermentation and the type of processing (with or without distillation) different types of alcoholic drinks are obtained. Wine and beer are produced without distillation whereas whisky, brandy and rum are produced by distillation of the fermented broth. The photograph of a fermentation plant is shown in Figure 8.5.

### 8.2.2 Antibiotics

Antibiotics produced by microbes are regarded as one of the most significant discoveries of the twentieth century and have greatly contributed towards the welfare of the human society. *Anti* is a Greek word that means 'against', and *bio* means 'life', together they mean 'against life' (in the context of disease causing organisms); whereas with reference to human beings, they are 'pro life' and not against. Antibiotics are chemical substances, which are produced by some microbes and can kill or retard the growth of other (disease-causing) microbes.

You are familiar with the commonly used antibiotic Penicillin. Do you know that Penicillin was the first antibiotic to be discovered, and it was a chance discovery? Alexander Fleming while working on *Staphylococci* bacteria, once observed a mould growing in one of his unwashed culture plates around which *Staphylococci* could not grow. He found out that it was due to a chemical produced by the mould and he named it Penicillin after the mould *Penicillium notatum*. However, its full potential as an effective antibiotic was established much later by Ernest Chain and Howard Florey. This antibiotic was extensively used to treat American soldiers wounded in World War II. Fleming, Chain and Florey were awarded the Nobel Prize in 1945, for this discovery.



After Penicillin, other antibiotics were also purified from other microbes. *Can you name some other antibiotics and find out their sources?* Antibiotics have greatly improved our capacity to treat deadly diseases such as plague, whooping cough (*kali khansi*), diphtheria (*gal ghotu*) and leprosy (*kusht rog*), which used to kill millions all over the globe. Today, we cannot imagine a world without antibiotics.

### 8.2.3 Chemicals, Enzymes and other Bioactive Molecules

Microbes are also used for commercial and industrial production of certain chemicals like organic acids, alcohols and enzymes. Examples of acid producers are *Aspergillus niger* (a fungus) of citric acid, *Acetobacter aceti* (a bacterium) of acetic acid; *Clostridium butylicum* (a bacterium) of butyric acid and *Lactobacillus* (a bacterium) of lactic acid.

Yeast (*Saccharomyces cerevisiae*) is used for commercial production of ethanol. Microbes are also used for production of enzymes. Lipases are used in detergent formulations and are helpful in removing oily stains from the laundry. You must have noticed that bottled fruit juices bought from the market are clearer as compared to those made at home. This is because the bottled juices are clarified by the use of pectinases and proteases. Streptokinase produced by the bacterium *Streptococcus* and modified by genetic engineering is used as a 'clot buster' for removing clots from the blood vessels of patients who have undergone myocardial infarction leading to heart attack.

Another bioactive molecule, cyclosporin A, that is used as an immunosuppressive agent in organ-transplant patients, is produced by the fungus *Trichoderma polysporum*. Statins produced by the yeast *Monascus purpureus* have been commercialised as blood-cholesterol lowering agents. It acts by competitively inhibiting the enzyme responsible for synthesis of cholesterol.

## 8.3 MICROBES IN SEWAGE TREATMENT

We know that large quantities of waste water are generated everyday in cities and towns. A major component of this waste water is human excreta. This municipal waste-water is also called sewage. It contains large amounts of organic matter and microbes. Many of which are pathogenic. Have you ever wondered where this huge quantity of sewage or urban waste water is disposed off daily? This cannot be discharged into natural water bodies like rivers and streams directly – you can understand why. Before disposal, hence, sewage is treated in sewage treatment plants (STPs) to make it less polluting. Treatment of waste water is done by the



**Figure 8.6** Secondary treatment

heterotrophic microbes naturally present in the sewage. This treatment is carried out in two stages:

**Primary treatment** : These treatment steps basically involve physical removal of particles – large and small – from the sewage through filtration and sedimentation. These are removed in stages; initially, floating debris is removed by sequential filtration. Then the grit (soil and small pebbles) are removed by sedimentation. All solids that settle form the **primary sludge**, and the supernatant forms the effluent. The effluent from the primary settling tank is taken for secondary treatment.

**Secondary treatment or Biological treatment** : The primary effluent is passed into large aeration tanks (Figure 8.6) where it is constantly agitated mechanically and air is pumped into it. This allows vigorous growth of useful aerobic microbes into **flocs** (masses of bacteria associated with fungal filaments to form mesh like structures). While growing, these microbes consume the major part of the organic matter in the effluent. This significantly reduces the **BOD (biochemical oxygen demand)** of the effluent. BOD refers to the amount of the oxygen that would be consumed if all the organic matter in one liter of water were oxidised by bacteria. The sewage water is treated till the BOD is reduced. The BOD test measures the rate of uptake of oxygen by micro-organisms in a sample of water and thus, indirectly, BOD is a measure of the organic matter present in the water. The greater the BOD of waste water, more is its polluting potential.

Once the BOD of sewage or waste water is reduced significantly, the effluent is then passed into a settling tank where the bacterial ‘flocs’ are allowed to sediment. This sediment is called **activated sludge**. A small part of the activated sludge is pumped back into the aeration tank to serve as the inoculum. The remaining major part of the sludge is pumped into large tanks called **anaerobic sludge digesters**. Here, other kinds of bacteria, which grow anaerobically, digest the bacteria and the fungi in the sludge. During this digestion, bacteria produce a mixture of gases such as methane, hydrogen sulphide and carbon dioxide. These gases form **biogas** and can be used as source of energy as it is inflammable.

The effluent from the secondary treatment plant is generally released into natural water bodies like rivers and streams. An aerial view of such a plant is shown in Figure 8.7.



You can appreciate how microbes play a major role in treating millions of gallons of waste water everyday across the globe. This methodology has been practiced for more than a century now, in almost all parts of the world. Till date, no man-made technology has been able to rival the microbial treatment of sewage.

You are aware that due to increasing urbanisation, sewage is being produced in much larger quantities than ever before. However the number of sewage treatment plants has not increased enough to treat such large quantities.

So the untreated sewage is often discharged directly into rivers leading to their pollution and increase in water-borne diseases.

The Ministry of Environment and Forests has initiated **Ganga Action Plan** and **Yamuna Action Plan** to save these major rivers of our country from pollution. Under these plans, it is proposed to build a large number of sewage treatment plants so that only treated sewage may be discharged in the rivers. A visit to a sewage treatment plant situated in any place near you would be a very interesting and educating experience.

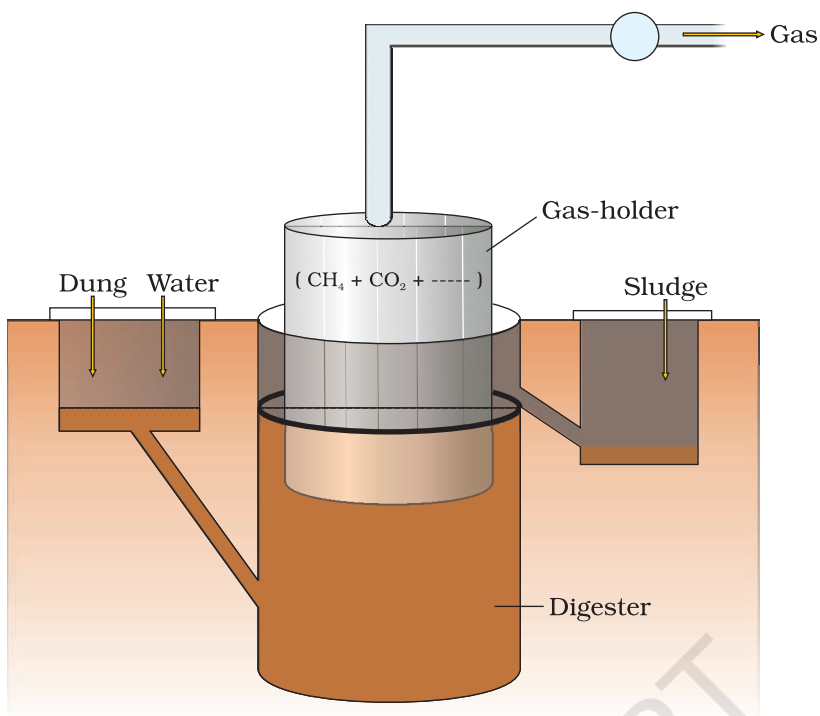


**Figure 8.7** An aerial view of a sewage plant

## 8.4 MICROBES IN PRODUCTION OF BIOGAS

Biogas is a mixture of gases (containing predominantly methane) produced by the microbial activity and which may be used as fuel. You have learnt that microbes produce different types of gaseous end-products during growth and metabolism. The type of the gas produced depends upon the microbes and the organic substrates they utilise. In the examples cited in relation to fermentation of dough, cheese making and production of beverages, the main gas produced was  $\text{CO}_2$ . However, certain bacteria, which grow anaerobically on cellulosic material, produce large amount of methane along with  $\text{CO}_2$  and  $\text{H}_2$ . These bacteria are collectively called **methanogens**, and one such common bacterium is *Methanobacterium*. These bacteria are commonly found in the anaerobic sludge during sewage treatment. These bacteria are also present in the rumen (a part of stomach) of cattle. A lot of cellulosic material present in the food of cattle is also present in the rumen. In rumen, these bacteria help in the breakdown of cellulose and play an important role in the nutrition of cattle. *Do you think we, human beings, are able to digest the cellulose present in our foods?* Thus, the excreta (dung) of cattle, commonly called *gobar*, is rich in these bacteria. Dung can be used for generation of biogas, commonly called *gobar gas*.

The biogas plant consists of a concrete tank (10-15 feet deep) in which bio-wastes are collected and a slurry of dung is fed. A floating cover is



**Figure 8.8** A typical biogas plant

placed over the slurry, which keeps on rising as the gas is produced in the tank due to the microbial activity. The biogas plant has an outlet, which is connected to a pipe to supply biogas to nearby houses. The spent slurry is removed through another outlet and may be used as fertiliser. Cattle dung is available in large quantities in rural areas where cattle are used for a variety of purposes. So biogas plants are more often built in rural areas. The biogas thus produced is used for cooking and lighting. The picture of a biogas plant is shown in Figure 8.8. The technology of biogas production was developed in India mainly

due to the efforts of Indian Agricultural Research Institute (IARI) and Khadi and Village Industries Commission (KVIC). If your school is situated in a village or near a village, it would be very interesting to enquire if there are any biogas plants nearby. Visit the biogas plant and learn more about it from the people who are actually managing it.

### 8.5 MICROBES AS BIOCONTROL AGENTS

Biocontrol refers to the use of biological methods for controlling plant diseases and pests. In modern society, these problems have been tackled increasingly by the use of chemicals – by use of insecticides and pesticides. These chemicals are toxic and extremely harmful, to human beings and animals alike, and have been polluting our environment (soil, ground water), fruits, vegetables and crop plants. Our soil is also polluted through our use of weedicides to remove weeds.

**Biological control of pests and diseases:** In agriculture, there is a method of controlling pests that relies on natural predation rather than introduced chemicals. A key belief of the organic farmer is that biodiversity furthers health. The more variety a landscape has, the more sustainable it is. The organic farmer, therefore, works to create a system where the insects that are sometimes called pests are not eradicated, but instead are kept at manageable levels by a complex system of checks and balances within a living and vibrant ecosystem. Contrary to the ‘conventional’ farming practices which often use chemical methods to kill both useful





and harmful life forms indiscriminately, this is a holistic approach that seeks to develop an understanding of the webs of interaction between the myriad of organisms that constitute the field fauna and flora. The organic farmer holds the view that the eradication of the creatures that are often described as pests is not only possible, but also undesirable, for without them the beneficial predatory and parasitic insects which depend upon them as food or hosts would not be able to survive. Thus, the use of biocontrol measures will greatly reduce our dependence on toxic chemicals and pesticides. An important part of the biological farming approach is to become familiar with the various life forms that inhabit the field, predators as well as pests, and also their life cycles, patterns of feeding and the habitats that they prefer. This will help develop appropriate means of biocontrol.

The very familiar beetle with red and black markings – the Ladybird, and Dragonflies are useful to get rid of aphids and mosquitoes, respectively. An example of microbial biocontrol agents that can be introduced in order to control butterfly caterpillars is the bacteria *Bacillus thuringiensis* (often written as *Bt*). These are available in sachets as dried spores which are mixed with water and sprayed onto vulnerable plants such as brassicas and fruit trees, where these are eaten by the insect larvae. In the gut of the larvae, the toxin is released and the larvae get killed. The bacterial disease will kill the caterpillars, but leave other insects unharmed. Because of the development of methods of genetic engineering in the last decade or so, the scientists have introduced *B. thuringiensis* toxin genes into plants. Such plants are resistant to attack by insect pests. **Bt-cotton** is one such example, which is being cultivated in some states of our country. You will learn more about this in chapter 10.

A biological control being developed for use in the treatment of plant disease is the fungus *Trichoderma*. *Trichoderma* species are free-living fungi that are very common in the root ecosystems. They are effective biocontrol agents of several plant pathogens.

Baculoviruses are pathogens that attack insects and other arthropods. The majority of baculoviruses used as biological control agents are in the genus *Nucleopolyhedrovirus*. These viruses are excellent candidates for species-specific, narrow spectrum insecticidal applications. They have been shown to have no negative impacts on plants, mammals, birds, fish or even on non-target insects. This is especially desirable when beneficial insects are being conserved to aid in an overall integrated pest management (IPM) programme, or when an ecologically sensitive area is being treated.

## 8.6 MICROBES AS BIOFERTILISERS

With our present day life styles environmental pollution is a major cause of concern. The use of the chemical fertilisers to meet the ever-increasing



demand of agricultural produce has contributed significantly to this pollution. Of course, we have now realised that there are problems associated with the overuse of chemical fertilisers and there is a large pressure to switch to **organic farming** – the use of **biofertilisers**. Biofertilisers are organisms that enrich the nutrient quality of the soil. The main sources of biofertilisers are bacteria, fungi and cyanobacteria. You have studied about the nodules on the roots of leguminous plants formed by the symbiotic association of *Rhizobium*. These bacteria fix atmospheric nitrogen into organic forms, which is used by the plant as nutrient. Other bacteria can fix atmospheric nitrogen while free-living in the soil (examples *Azospirillum* and *Azotobacter*), thus enriching the nitrogen content of the soil.

Fungi are also known to form symbiotic associations with plants (**mycorrhiza**). Many members of the genus *Glomus* form mycorrhiza. The fungal symbiont in these associations absorbs phosphorus from soil and passes it to the plant. Plants having such associations show other benefits also, such as resistance to root-borne pathogens, tolerance to salinity and drought, and an overall increase in plant growth and development. *Can you tell what advantage the fungus derives from this association?*

Cyanobacteria are autotrophic microbes widely distributed in aquatic and terrestrial environments many of which can fix atmospheric nitrogen, e.g. *Anabaena*, *Nostoc*, *Oscillatoria*, etc. In paddy fields, cyanobacteria serve as an important biofertiliser. Blue green algae also add organic matter to the soil and increase its fertility. Currently, in our country, a number of biofertilisers are available commercially in the market and farmers use these regularly in their fields to replenish soil nutrients and to reduce dependence on chemical fertilisers.

### SUMMARY

Microbes are a very important component of life on earth. Not all microbes are pathogenic. Many microbes are very useful to human beings. We use microbes and microbially derived products almost every day. Bacteria called lactic acid bacteria (LAB) grow in milk to convert it into curd. The dough, which is used to make bread, is fermented by yeast called *Saccharomyces cerevisiae*. Certain dishes such as *idli* and *dosa*, are made from dough fermented by microbes. Bacteria and fungi are used to impart particular texture, taste and flavor to cheese. Microbes are used to produce industrial products like lactic acid, acetic acid and alcohol, which are used in a variety of processes in the industry. Antibiotics like penicillins produced by useful microbes are used to kill disease-causing harmful microbes. Antibiotics have played a major role in controlling infectious diseases like diphtheria, whooping cough and





pneumonia. For more than a hundred years, microbes are being used to treat sewage (waste water) by the process of activated sludge formation and this helps in recycling of water in nature. Methanogens produce methane (biogas) while degrading plant waste. Biogas produced by microbes is used as a source of energy in rural areas. Microbes can also be used to kill harmful pests, a process called as biocontrol. The biocontrol measures help us to avoid heavy use of toxic pesticides for controlling pests. There is a need these days to push for use of biofertilisers in place of chemical fertilisers. It is clear from the diverse uses human beings have put microbes to that they play an important role in the welfare of human society.



## EXERCISES

1. Bacteria cannot be seen with the naked eyes, but these can be seen with the help of a microscope. If you have to carry a sample from your home to your biology laboratory to demonstrate the presence of microbes with the help of a microscope, which sample would you carry and why?
2. Give examples to prove that microbes release gases during metabolism.
3. In which food would you find lactic acid bacteria? Mention some of their useful applications.
4. Name some traditional Indian foods made of wheat, rice and Bengal gram (or their products) which involve use of microbes.
5. In which way have microbes played a major role in controlling diseases caused by harmful bacteria?
6. Name any two species of fungus, which are used in the production of the antibiotics.
7. What is sewage? In which way can sewage be harmful to us?
8. What is the key difference between primary and secondary sewage treatment?
9. Do you think microbes can also be used as source of energy? If yes, how?
10. Microbes can be used to decrease the use of chemical fertilisers and pesticides. Explain how this can be accomplished.
11. Three water samples namely river water, untreated sewage water and secondary effluent discharged from a sewage treatment plant were subjected to BOD test. The samples were labelled A, B and C; but the laboratory attendant did not note which was which. The BOD values of the three samples A, B and C were recorded as 20mg/L, 8mg/L and 400mg/L, respectively. Which sample of the water is most polluted? Can you assign the correct label to each assuming the river water is relatively clean?



12. Find out the name of the microbes from which Cyclosporin A (an immunosuppressive drug) and Statins (blood cholesterol lowering agents) are obtained.
13. Find out the role of microbes in the following and discuss it with your teacher.
  - (a) Single cell protein (SCP)
  - (b) Soil
14. Arrange the following in the decreasing order (most important first) of their importance, for the welfare of human society. Give reasons for your answer.  
Biogas, Citric acid, Penicillin and Curd
15. How do biofertilisers enrich the fertility of the soil?



# UNIT IX

# BIOTECHNOLOGY

## **Chapter 9**

Biotechnology : Principles and Processes

## **Chapter 10**

Biotechnology and Its Applications

Ever since the days of Rene Descartes, the French philosopher, mathematician and biologist of seventeenth century, all human knowledge especially natural sciences were directed to develop technologies which add to the creature comforts of human lives, as also value to human life. The whole approach to understanding natural phenomena became anthropocentric. Physics and chemistry gave rise to engineering, technologies and industries which all worked for human comfort and welfare. The major utility of the biological world is as a source of food. Biotechnology, the twentieth century off-shoot of modern biology, changed our daily life as its products brought qualitative improvement in health and food production. The basic principles underlying biotechnological processes and some applications are highlighted and discussed in this unit.





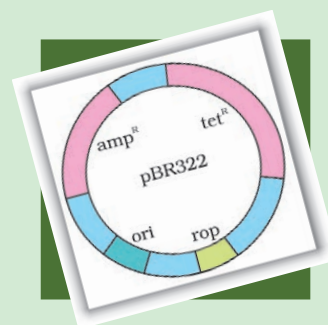
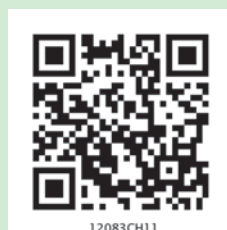
HERBERT BOYER  
(1936 )

Herbert Boyer was born in 1936 and brought up in a corner of western Pennsylvania where railroads and mines were the destiny of most young men. He completed graduate work at the University of Pittsburgh, in 1963, followed by three years of post-graduate studies at Yale.

In 1966, Boyer took over assistant professorship at the University of California at San Francisco. By 1969, he performed studies on a couple of restriction enzymes of the *E. coli* bacterium with especially useful properties. Boyer observed that these enzymes have the capability of cutting DNA strands in a particular fashion, which left what has become known as 'sticky ends' on the strands. These clipped ends made pasting together pieces of DNA a precise exercise.

This discovery, in turn, led to a rich and rewarding conversation in Hawaii with a Stanford scientist named Stanley Cohen. Cohen had been studying small ringlets of DNA called plasmids and which float about freely in the cytoplasm of certain bacterial cells and replicate independently from the coding strand of DNA. Cohen had developed a method of removing these plasmids from the cell and then reinserting them in other cells. Combining this process with that of DNA splicing enabled Boyer and Cohen to recombine segments of DNA in desired configurations and insert the DNA in bacterial cells, which could then act as manufacturing plants for specific proteins. This breakthrough was the basis upon which the discipline of biotechnology was founded.

# CHAPTER 9



## BIOTECHNOLOGY : PRINCIPLES AND PROCESSES

### 9.1 Principles of Biotechnology

### 9.2 Tools of Recombinant DNA Technology

### 9.3 Processes of Recombinant DNA Technology

**Biotechnology** deals with techniques of using live organisms or enzymes from organisms to produce products and processes useful to humans. In this sense, making curd, bread or wine, which are all microbe-mediated processes, could also be thought as a form of biotechnology. However, it is used in a restricted sense today, to refer to such of those processes which use genetically modified organisms to achieve the same on a larger scale. Further, many other processes/techniques are also included under biotechnology. For example, *in vitro* fertilisation leading to a 'test-tube' baby, synthesising a gene and using it, developing a DNA vaccine or correcting a defective gene, are all part of biotechnology.

The European Federation of Biotechnology (EFB) has given a definition of biotechnology that encompasses both traditional view and modern molecular biotechnology. The definition given by EFB is as follows:

'The integration of natural science and organisms, cells, parts thereof, and molecular analogues for products and services'.

### 9.1 PRINCIPLES OF BIOTECHNOLOGY

Among many, the two core techniques that enabled birth of modern biotechnology are :

- (i) **Genetic engineering** : Techniques to alter the chemistry of genetic material (DNA and RNA),



to introduce these into host organisms and thus change the phenotype of the host organism.

- (ii) **Bioprocess engineering:** Maintenance of sterile (microbial contamination-free) ambience in chemical engineering processes to enable growth of only the desired microbe/eukaryotic cell in large quantities for the manufacture of biotechnological products like antibiotics, vaccines, enzymes, etc.

Let us now understand the conceptual development of the principles of genetic engineering.

You probably appreciate the advantages of sexual reproduction over asexual reproduction. The former provides opportunities for variations and formulation of unique combinations of genetic setup, some of which may be beneficial to the organism as well as the population. Asexual reproduction preserves the genetic information, while sexual reproduction permits variation. Traditional hybridisation procedures used in plant and animal breeding, very often lead to inclusion and multiplication of undesirable genes along with the desired genes. The techniques of genetic engineering which include creation of **recombinant DNA**, use of **gene cloning** and **gene transfer**, overcome this limitation and allows us to isolate and introduce only one or a set of desirable genes without introducing undesirable genes into the target organism.

Do you know the likely fate of a piece of DNA, which is somehow transferred into an alien organism? Most likely, this piece of DNA would not be able to multiply itself in the progeny cells of the organism. But, when it gets integrated into the genome of the recipient, it may multiply and be inherited along with the host DNA. This is because the alien piece of DNA has become part of a chromosome, which has the ability to replicate. In a chromosome there is a specific DNA sequence called the **origin of replication**, which is responsible for initiating replication. Therefore, for the multiplication of any alien piece of DNA in an organism it needs to be a part of a chromosome(s) which has a specific sequence known as 'origin of replication'. Thus, an alien DNA is linked with the origin of replication, so that, this alien piece of DNA can replicate and multiply itself in the host organism. This can also be called as **cloning** or making multiple identical copies of any template DNA.

Let us now focus on the first instance of the construction of an artificial recombinant DNA molecule. The construction of the first recombinant DNA emerged from the possibility of linking a gene encoding antibiotic resistance with a native **plasmid** (autonomously replicating circular extra-chromosomal DNA) of *Salmonella typhimurium*. Stanley Cohen and Herbert Boyer accomplished this in 1972 by isolating the antibiotic resistance gene by cutting out a piece of DNA from a plasmid which was responsible for conferring antibiotic resistance. The cutting of DNA at specific locations became possible with the discovery of the so-called





'molecular scissors'– **restriction enzymes**. The cut piece of DNA was then linked with the plasmid DNA. These plasmid DNA act as **vectors** to transfer the piece of DNA attached to it. You probably know that mosquito acts as an insect vector to transfer the malarial parasite into human body. In the same way, a plasmid can be used as vector to deliver an alien piece of DNA into the host organism. The linking of antibiotic resistance gene with the plasmid vector became possible with the enzyme DNA ligase, which acts on cut DNA molecules and joins their ends. This makes a new combination of circular autonomously replicating DNA created *in vitro* and is known as recombinant DNA. When this DNA is transferred into *Escherichia coli*, a bacterium closely related to *Salmonella*, it could replicate using the new host's DNA polymerase enzyme and make multiple copies. The ability to multiply copies of antibiotic resistance gene in *E. coli* was called **cloning** of antibiotic resistance gene in *E. coli*.

You can hence infer that there are three basic steps in genetically modifying an organism —

- (i) identification of DNA with desirable genes;
- (ii) introduction of the identified DNA into the host;
- (iii) maintenance of introduced DNA in the host and transfer of the DNA to its progeny.

## 9.2 TOOLS OF RECOMBINANT DNA TECHNOLOGY

Now we know from the foregoing discussion that genetic engineering or recombinant DNA technology can be accomplished only if we have the key tools, i.e., restriction enzymes, polymerase enzymes, ligases, vectors and the host organism. Let us try to understand some of these in detail.

### 9.2.1 Restriction Enzymes

In the year 1963, the two enzymes responsible for restricting the growth of bacteriophage in *Escherichia coli* were isolated. One of these added methyl groups to DNA, while the other cut DNA. The later was called **restriction endonuclease**.

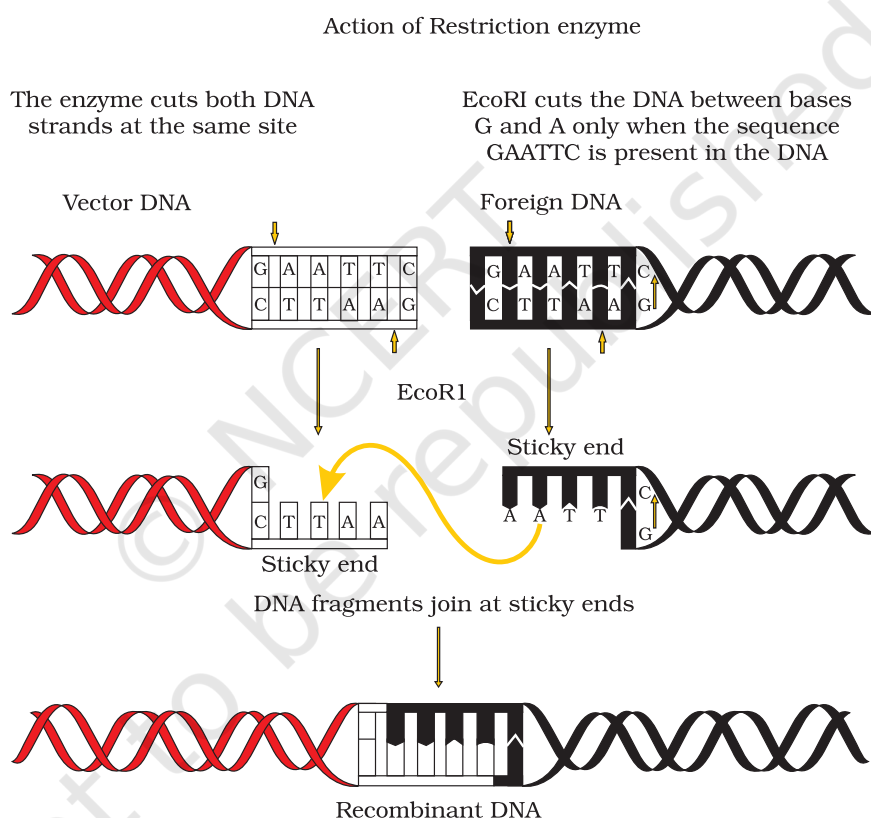
The first restriction endonuclease—*Hind II*, whose functioning depended on a specific DNA nucleotide sequence was isolated and characterised five years later. It was found that *Hind II* always cut DNA molecules at a particular point by recognising a specific sequence of six base pairs. This specific base sequence is known as the **recognition sequence** for *Hind II*. Besides *Hind II*, today we know more than 900 restriction enzymes that have been isolated from over 230 strains of bacteria each of which recognise different recognition sequences.

The convention for naming these enzymes is the first letter of the name comes from the genus and the second two letters come from the species of the prokaryotic cell from which they were isolated, e.g., EcoRI comes from *Escherichia coli* RY 13. In EcoRI, the letter 'R' is derived from the name of

strain. Roman numbers following the names indicate the order in which the enzymes were isolated from that strain of bacteria.

Restriction enzymes belong to a larger class of enzymes called **nucleases**. These are of two kinds; **exonucleases** and **endonucleases**. Exonucleases remove nucleotides from the ends of the DNA whereas, endonucleases make cuts at specific positions within the DNA.

Each restriction endonuclease functions by 'inspecting' the length of a DNA sequence. Once it finds its specific recognition sequence, it will bind to the DNA and cut each of the two strands of the double helix at specific points in their sugar-phosphate backbones (Figure 9.1). Each restriction endonuclease recognises a specific **palindromic nucleotide sequences** in the DNA.



**Figure 9.1** Steps in formation of recombinant DNA by action of restriction endonuclease enzyme - EcoRI

Do you know what palindromes are? These are groups of letters that form the same words when read both forward and backward, e.g., "MALAYALAM". As against a word-palindrome where the same word is read in both directions, the palindrome in DNA is a sequence of base pairs that reads same on the two strands when orientation of



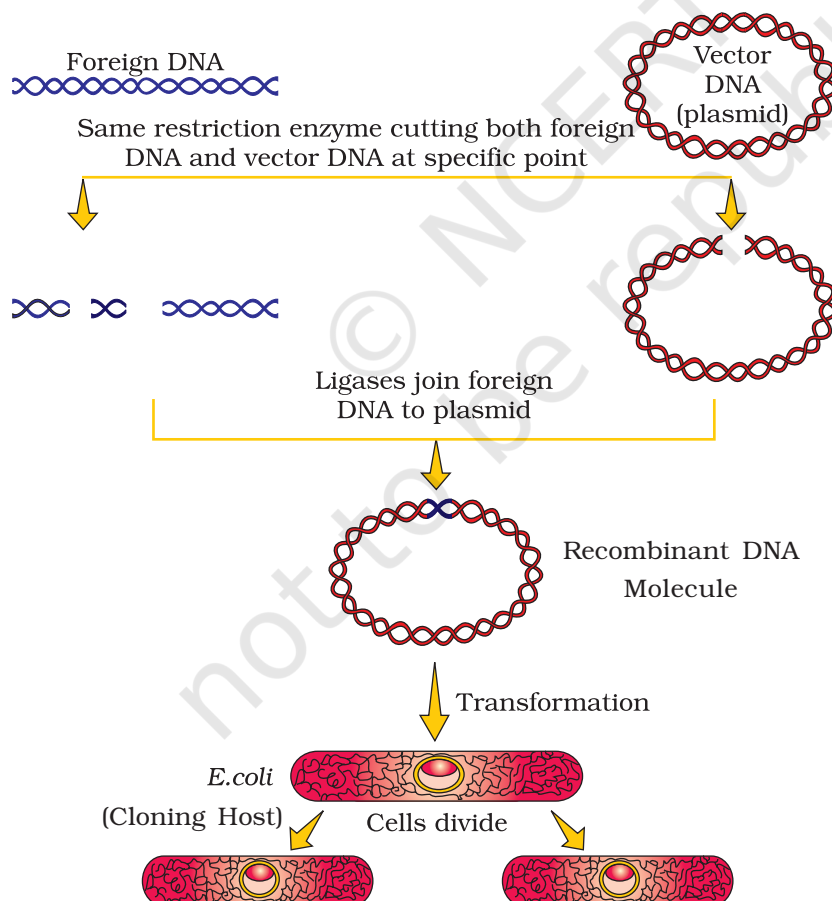
reading is kept the same. For example, the following sequences reads the same on the two strands in 5' → 3' direction. This is also true if read in the 3' → 5' direction.



Restriction enzymes cut the strand of DNA a little away from the centre of the palindrome sites, but between the same two bases on the opposite strands. This leaves single stranded portions at the ends. There are overhanging stretches called sticky ends on each strand (Figure 9.1). These are named so because they form hydrogen bonds with their complementary cut counterparts. This stickiness of the ends facilitates the action of the enzyme DNA ligase.

Restriction endonucleases are used in genetic engineering to form 'recombinant' molecules of DNA, which are composed of DNA from different sources/genomes.

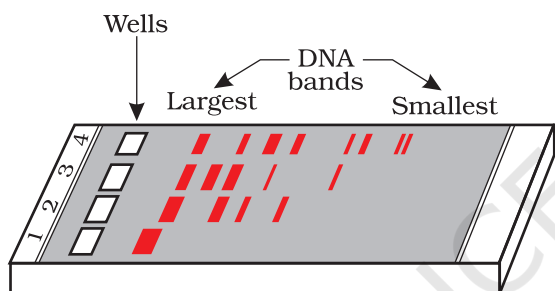
When cut by the same restriction enzyme, the resultant DNA fragments have the same kind of 'sticky-ends' and, these can be joined together (end-to-end) using DNA ligases (Figure 9.2).



**Figure 9.2** Diagrammatic representation of recombinant DNA technology

You may have realised that normally, unless one cuts the vector and the source DNA with the same restriction enzyme, the recombinant vector molecule cannot be created.

**Separation and isolation of DNA fragments :** The cutting of DNA by restriction endonucleases results in the fragments of DNA. These fragments can be separated by a technique known as **gel electrophoresis**. Since DNA fragments are negatively charged molecules they can be separated by forcing them to move towards the anode under an electric field through a medium/matrix. Nowadays the most commonly used matrix is agarose which is a natural polymer extracted from sea weeds. The DNA fragments separate (resolve) according to their size through sieving effect provided by the agarose gel. Hence, the smaller the fragment size, the farther it moves. *Look at the Figure 9.3 and guess at which end of the gel the sample was loaded.*



**Figure 9.3** A typical agarose gel electrophoresis showing migration of undigested (lane 1) and digested set of DNA fragments (lane 2 to 4)

The separated DNA fragments can be visualised only after staining the DNA with a compound known as ethidium bromide followed by exposure to UV radiation (you cannot see pure DNA fragments in the visible light and without staining). You can see bright orange coloured bands of DNA in a ethidium bromide stained gel exposed to UV light (Figure 9.3). The separated bands of DNA are cut out from the agarose gel and extracted from the gel piece. This step is known as elution. The DNA fragments purified in this way are used in constructing recombinant DNA by joining them with cloning vectors.

### 9.2.2 Cloning Vectors

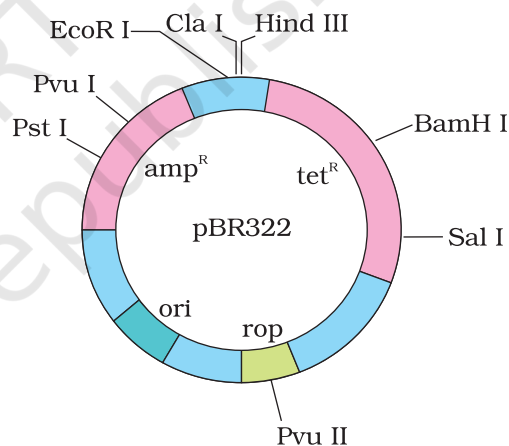
You know that plasmids and bacteriophages have the ability to replicate within bacterial cells independent of the control of chromosomal DNA. Bacteriophages because of their high number per cell, have very high copy numbers of their genome within the bacterial cells. Some plasmids may have only one or two copies per cell whereas others may have 15-100 copies per cell. Their numbers can go even higher. If we are able to link an alien piece of DNA with bacteriophage or plasmid DNA, we can multiply its numbers equal to the copy number of the plasmid or bacteriophage. Vectors used at present, are engineered in such a way that they help easy linking of foreign DNA and selection of recombinants from non-recombinants.



The following are the features that are required to facilitate cloning into a vector.

- (i) **Origin of replication (ori)** : This is a sequence from where replication starts and any piece of DNA when linked to this sequence can be made to replicate within the host cells. This sequence is also responsible for controlling the copy number of the linked DNA. So, if one wants to recover many copies of the target DNA it should be cloned in a vector whose origin support high copy number.
- (ii) **Selectable marker** : In addition to 'ori', the vector requires a selectable marker, which helps in identifying and eliminating non-transformants and selectively permitting the growth of the transformants. **Transformation** is a procedure through which a piece of DNA is introduced in a host bacterium (you will study the process in subsequent section). Normally, the genes encoding resistance to antibiotics such as ampicillin, chloramphenicol, tetracycline or kanamycin, etc., are considered useful selectable markers for *E. coli*. The normal *E. coli* cells do not carry resistance against any of these antibiotics.

- (iii) **Cloning sites**: In order to link the alien DNA, the vector needs to have very few, preferably single, **recognition sites** for the commonly used restriction enzymes. Presence of more than one recognition sites within the vector will generate several fragments, which will complicate the gene cloning (Figure 9.4). The ligation of alien DNA is carried out at a restriction site present in one of the two **antibiotic resistance** genes. For example, you can ligate a foreign DNA at the BamH I site of tetracycline resistance gene in the vector pBR322. The recombinant plasmids will lose tetracycline resistance due to insertion of foreign DNA but can still be selected out from non-recombinant ones by plating the transformants on tetracycline containing medium. The transformants growing on ampicillin containing medium are then transferred on a medium containing tetracycline. The recombinants will grow in ampicillin containing medium but not on that containing tetracycline. But, non-recombinants will grow on the medium containing both the antibiotics. In this case, one antibiotic resistance gene helps in selecting the transformants, whereas the other antibiotic resistance



**Figure 9.4** *E. coli* cloning vector pBR322 showing restriction sites (*Hind* III, *Eco*R I, *Bam*H I, *Sal* I, *Pvu* II, *Pst* I, *Cla* I), ori and antibiotic resistance genes ( $amp^R$  and  $tet^R$ ). *rop* codes for the proteins involved in the replication of the plasmid.



gene gets 'inactivated due to insertion' of alien DNA, and helps in selection of recombinants.

Selection of recombinants due to inactivation of antibiotics is a cumbersome procedure because it requires simultaneous plating on two plates having different antibiotics. Therefore, alternative selectable markers have been developed which differentiate recombinants from non-recombinants on the basis of their ability to produce colour in the presence of a chromogenic substrate. In this, a recombinant DNA is inserted within the coding sequence of an enzyme,  $\beta$ -galactosidase. This results into inactivation of the gene for synthesis of this enzyme, which is referred to as **insertional inactivation**. The presence of a chromogenic substrate gives blue coloured colonies if the plasmid in the bacteria does not have an insert. Presence of insert results into insertional inactivation of the  $\beta$ -galactosidase gene and the colonies do not produce any colour, these are identified as recombinant colonies.

- (iv) **Vectors for cloning genes in plants and animals** : You may be surprised to know that we have learnt the lesson of transferring genes into plants and animals from bacteria and viruses which have known this for ages – how to deliver genes to transform eukaryotic cells and force them to do what the bacteria or viruses want. For example, *Agrobacterium tumifaciens*, a pathogen of several dicot plants is able to deliver a piece of DNA known as 'T-DNA' to transform normal plant cells into a **tumor** and direct these tumor cells to produce the chemicals required by the pathogen. Similarly, retroviruses in animals have the ability to transform normal cells into **cancerous** cells. A better understanding of the art of delivering genes by pathogens in their eukaryotic hosts has generated knowledge to transform these tools of pathogens into useful vectors for delivering genes of interest to humans. The tumor inducing (Ti) plasmid of *Agrobacterium tumifaciens* has now been modified into a cloning vector which is no more pathogenic to the plants but is still able to use the mechanisms to deliver genes of our interest into a variety of plants. Similarly, retroviruses have also been disarmed and are now used to deliver desirable genes into animal cells. So, once a gene or a DNA fragment has been ligated into a suitable vector it is transferred into a bacterial, plant or animal host (where it multiplies).

### 9.2.3 Competent Host (For Transformation with Recombinant DNA)

Since DNA is a hydrophilic molecule, it cannot pass through cell membranes. *Why?* In order to force bacteria to take up the plasmid, the bacterial cells must first be made 'competent' to take up DNA. This is done by treating them with a specific concentration of a divalent cation, such as calcium, which increases the efficiency with which DNA enters



the bacterium through pores in its cell wall. Recombinant DNA can then be forced into such cells by incubating the cells with recombinant DNA on ice, followed by placing them briefly at 42°C (heat shock), and then putting them back on ice. This enables the bacteria to take up the recombinant DNA.

This is not the only way to introduce alien DNA into host cells. In a method known as **micro-injection**, recombinant DNA is directly injected into the nucleus of an animal cell. In another method, suitable for plants, cells are bombarded with high velocity micro-particles of gold or tungsten coated with DNA in a method known as **biolistics** or **gene gun**. And the last method uses 'disarmed pathogen' vectors, which when allowed to infect the cell, transfer the recombinant DNA into the host.

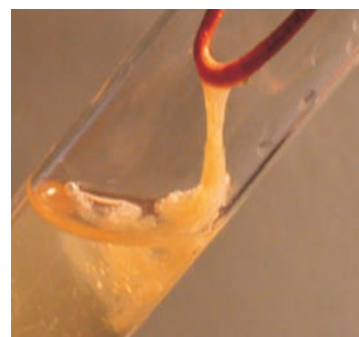
Now that we have learnt about the tools for constructing recombinant DNA, let us discuss the processes facilitating recombinant DNA technology.

### 9.3 PROCESSES OF RECOMBINANT DNA TECHNOLOGY

Recombinant DNA technology involves several steps in specific sequence such as isolation of DNA, fragmentation of DNA by restriction endonucleases, isolation of a desired DNA fragment, ligation of the DNA fragment into a vector, transferring the recombinant DNA into the host, culturing the host cells in a medium at large scale and extraction of the desired product. Let us examine each of these steps in some details.

#### 9.3.1 Isolation of the Genetic Material (DNA)

Recall that nucleic acid is the genetic material of all organisms without exception. In majority of organisms this is deoxyribonucleic acid or DNA. In order to cut the DNA with restriction enzymes, it needs to be in pure form, free from other macro-molecules. Since the DNA is enclosed within the membranes, we have to break the cell open to release DNA along with other macromolecules such as RNA, proteins, polysaccharides and also lipids. This can be achieved by treating the bacterial cells/plant or animal tissue with enzymes such as **lysozyme** (bacteria), **cellulase** (plant cells), **chitinase** (fungus). You know that genes are located on long molecules of DNA intertwined with proteins such as histones. The RNA can be removed by treatment with ribonuclease whereas proteins can be removed by treatment with protease. Other molecules can be removed by appropriate treatments and purified DNA ultimately precipitates out after the addition of chilled ethanol. This can be seen as collection of fine threads in the suspension (Figure 9.5).



**Figure 9.5** DNA that separates out can be removed by spooling



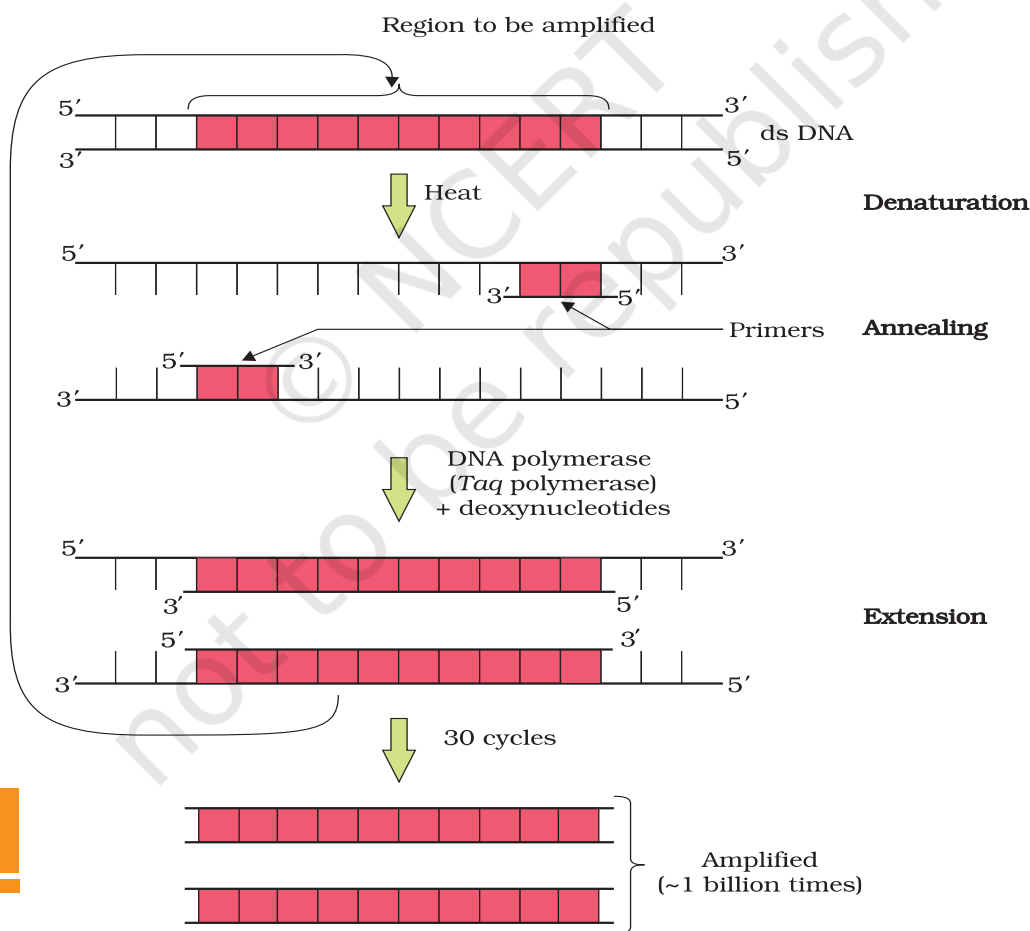
### 9.3.2 Cutting of DNA at Specific Locations

Restriction enzyme digestions are performed by incubating purified DNA molecules with the restriction enzyme, at the optimal conditions for that specific enzyme. Agarose gel electrophoresis is employed to check the progression of a restriction enzyme digestion. DNA is a negatively charged molecule, hence it moves towards the positive electrode (anode) (Figure 9.3). The process is repeated with the vector DNA also.

The joining of DNA involves several processes. After having cut the source DNA as well as the vector DNA with a specific restriction enzyme, the cut out 'gene of interest' from the source DNA and the cut vector with space are mixed and ligase is added. This results in the preparation of recombinant DNA.

### 9.3.3 Amplification of Gene of Interest using PCR

PCR stands for **Polymerase Chain Reaction**. In this reaction, multiple copies of the gene (or DNA) of interest is synthesised *in vitro* using two



**Figure 9.6** Polymerase chain reaction (PCR) : Each cycle has three steps: (i) Denaturation; (ii) Primer annealing; and (iii) Extension of primers





sets of primers (small chemically synthesised oligonucleotides that are complementary to the regions of DNA) and the enzyme DNA polymerase. The enzyme extends the primers using the nucleotides provided in the reaction and the genomic DNA as template. If the process of replication of DNA is repeated many times, the segment of DNA can be amplified to approximately billion times, i.e., 1 billion copies are made. Such repeated amplification is achieved by the use of a thermostable DNA polymerase (isolated from a bacterium, *Thermus aquaticus*), which remain active during the high temperature induced denaturation of double stranded DNA. The amplified fragment if desired can now be used to ligate with a vector for further cloning (Figure 9.6).

### 9.3.4 Insertion of Recombinant DNA into the Host Cell/Organism

There are several methods of introducing the ligated DNA into recipient cells. Recipient cells after making them 'competent' to receive, take up DNA present in its surrounding. So, if a recombinant DNA bearing gene for resistance to an antibiotic (e.g., ampicillin) is transferred into *E. coli* cells, the host cells become transformed into ampicillin-resistant cells. If we spread the transformed cells on agar plates containing ampicillin, only transformants will grow, untransformed recipient cells will die. Since, due to ampicillin resistance gene, one is able to select a transformed cell in the presence of ampicillin. The ampicillin resistance gene in this case is called a **selectable marker**.

### 9.3.5 Obtaining the Foreign Gene Product

When you insert a piece of alien DNA into a cloning vector and transfer it into a bacterial, plant or animal cell, the alien DNA gets multiplied. In almost all recombinant technologies, the ultimate aim is to produce a desirable protein. Hence, there is a need for the recombinant DNA to be expressed. The foreign gene gets expressed under appropriate conditions. The expression of foreign genes in host cells involve understanding many technical details.

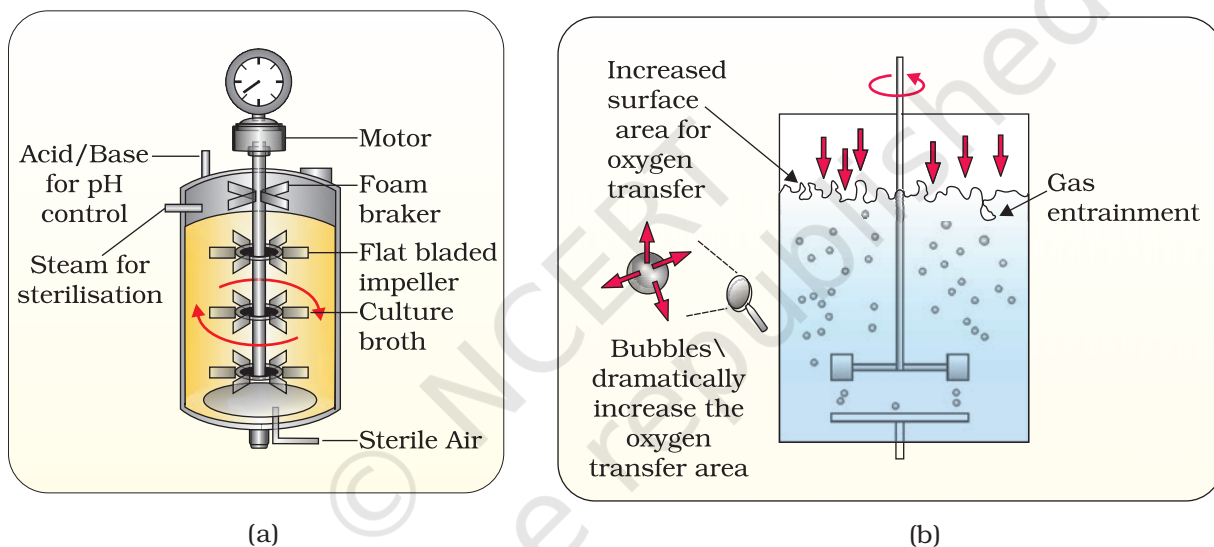
After having cloned the gene of interest and having optimised the conditions to induce the expression of the target protein, one has to consider producing it on a large scale. *Can you think of any reason why there is a need for large-scale production?* If any protein encoding gene is expressed in a heterologous host, it is called a **recombinant protein**. The cells harbouring cloned genes of interest may be grown on a small scale in the laboratory. The cultures may be used for extracting the desired protein and then purifying it by using different separation techniques.

The cells can also be multiplied in a continuous culture system wherein the used medium is drained out from one side while fresh medium is added from the other to maintain the cells in their physiologically most

active log/exponential phase. This type of culturing method produces a larger biomass leading to higher yields of desired protein.

Small volume cultures cannot yield appreciable quantities of products. To produce in large quantities, the development of **bioreactors**, where large volumes (100-1000 litres) of culture can be processed, was required. Thus, bioreactors can be thought of as vessels in which raw materials are biologically converted into specific products, individual enzymes, etc., using microbial plant, animal or human cells. A bioreactor provides the optimal conditions for achieving the desired product by providing optimum growth conditions (temperature, pH, substrate, salts, vitamins, oxygen).

The most commonly used bioreactors are of stirring type, which are shown in Figure 9.7.



**Figure 9.7** (a) Simple stirred-tank bioreactor; (b) Sparged stirred-tank bioreactor through which sterile air bubbles are sparged

A stirred-tank reactor is usually cylindrical or with a curved base to facilitate the mixing of the reactor contents. The stirrer facilitates even mixing and oxygen availability throughout the bioreactor. Alternatively air can be bubbled through the reactor. If you look at the figure closely you will see that the bioreactor has an agitator system, an oxygen delivery system and a foam control system, a temperature control system, pH control system and sampling ports so that small volumes of the culture can be withdrawn periodically.

### 9.3.6 Downstream Processing

After completion of the biosynthetic stage, the product has to be subjected through a series of processes before it is ready for marketing as a finished



product. The processes include separation and purification, which are collectively referred to as downstream processing. The product has to be formulated with suitable preservatives. Such formulation has to undergo thorough clinical trials as in case of drugs. Strict quality control testing for each product is also required. The downstream processing and quality control testing vary from product to product.

### SUMMARY

Biotechnology deals with large scale production and marketing of products and processes using live organisms, cells or enzymes. Modern biotechnology using genetically modified organisms was made possible only when man learnt to alter the chemistry of DNA and construct recombinant DNA. This key process is called recombinant DNA technology or genetic engineering. This process involves the use of restriction endonucleases, DNA ligase, appropriate plasmid or viral vectors to isolate and ferry the foreign DNA into host organisms, expression of the foreign gene, purification of the gene product, i.e., the functional protein and finally making a suitable formulation for marketing. Large scale production involves use of bioreactors.



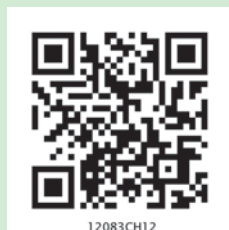
## EXERCISES

1. Can you list 10 recombinant proteins which are used in medical practice? Find out where they are used as therapeutics (use the internet).
2. Make a chart (with diagrammatic representation) showing a restriction enzyme, the substrate DNA on which it acts, the site at which it cuts DNA and the product it produces.
3. From what you have learnt, can you tell whether enzymes are bigger or DNA is bigger in molecular size? How did you know?
4. What would be the molar concentration of human DNA in a human cell? Consult your teacher.
5. Do eukaryotic cells have restriction endonucleases? Justify your answer.
6. Besides better aeration and mixing properties, what other advantages do stirred tank bioreactors have over shake flasks?
7. Collect 5 examples of palindromic DNA sequences by consulting your teacher. Better try to create a palindromic sequence by following base-pair rules.
8. Can you recall meiosis and indicate at what stage a recombinant DNA is made?
9. Can you think and answer how a reporter enzyme can be used to monitor transformation of host cells by foreign DNA in addition to a selectable marker?



10. Describe briefly the following:
    - (a) Origin of replication
    - (b) Bioreactors
    - (c) Downstream processing
  11. Explain briefly
    - (a) PCR
    - (b) Restriction enzymes and DNA
    - (c) Chitinase
  12. Discuss with your teacher and find out how to distinguish between
    - (a) Plasmid DNA and Chromosomal DNA
    - (b) RNA and DNA
    - (c) Exonuclease and Endonuclease
-

# CHAPTER 10



# BIOTECHNOLOGY AND ITS APPLICATIONS

- 10.1 *Biotechnological Applications in Agriculture*
- 10.2 *Biotechnological Applications in Medicine*
- 10.3 *Transgenic Animals*
- 10.4 *Ethical Issues*

Biotechnology, as you would have learnt from the previous chapter, essentially deals with industrial scale production of biopharmaceuticals and biologicals using genetically modified microbes, fungi, plants and animals. The applications of biotechnology include therapeutics, diagnostics, genetically modified crops for agriculture, processed food, bioremediation, waste treatment, and energy production. Three critical research areas of biotechnology are:

- (i) Providing the best catalyst in the form of improved organism usually a microbe or pure enzyme.
- (ii) Creating optimal conditions through engineering for a catalyst to act, and
- (iii) Downstream processing technologies to purify the protein/organic compound.

Let us now learn how human beings have used biotechnology to improve the quality of human life, especially in the field of food production and health.

## 10.1 BIOTECHNOLOGICAL APPLICATIONS IN AGRICULTURE

Let us take a look at the three options that can be thought for increasing food production

- (i) agro-chemical based agriculture;

- (ii) organic agriculture; and
- (iii) genetically engineered crop-based agriculture.

The **Green Revolution** succeeded in tripling the food supply but yet it was not enough to feed the growing human population. Increased yields have partly been due to the use of improved crop varieties, but mainly due to the use of better management practices and use of agrochemicals (fertilisers and pesticides). However, for farmers in the developing world, agrochemicals are often too expensive, and further increases in yield with existing varieties are not possible using conventional breeding.

As traditional breeding techniques failed to keep pace with demand and to provide sufficiently fast and efficient systems for crop improvement, another technology called **tissue culture** got developed. What does tissue culture mean? It was learnt by scientists, during 1950s, that whole plants could be regenerated from **explants**, i.e., any part of a plant taken out and grown in a test tube, under sterile conditions in special nutrient media. This capacity to generate a whole plant from any cell/explant is called **totipotency**. You will learn how to accomplish this in higher classes. It is important to stress here that the nutrient medium must provide a carbon source such as sucrose and also inorganic salts, vitamins, amino acids and growth regulators like auxins, cytokinins etc. By application of these methods it is possible to achieve propagation of a large number of plants in very short durations. This method of producing thousands of plants through tissue culture is called **micro-propagation**. Each of these plants will be genetically identical to the original plant from which they were grown, i.e., they are **somaclones**. Many important food plants like tomato, banana, apple, etc., have been produced on commercial scale using this method. Try to visit a tissue culture laboratory with your teacher to better understand and appreciate the process.

Another important application of the method is the recovery of healthy plants from diseased plants. Even if the plant is infected with a virus, the **meristem** (apical and axillary) is free of virus. Hence, one can remove the meristem and grow it *in vitro* to obtain virus-free plants. Scientists have succeeded in culturing meristems of banana, sugarcane, potato, etc.

Scientists have even isolated single cells from plants and after digesting their cell walls have been able to isolate naked protoplasts (surrounded by plasma membranes). Isolated protoplasts from two different varieties of plants – each having a desirable character – can be fused to get hybrid protoplasts, which can be further grown to form a new plant. These hybrids are called **somatic hybrids** while the process



is called **somatic hybridisation**. Imagine a situation when a protoplast of tomato is fused with that of potato, and then they are grown – to form new hybrid plants combining tomato and potato characteristics. Well, this has been achieved – resulting in formation of pomato; unfortunately this plant did not have all the desired combination of characteristics for its commercial utilisation.

Is there any alternative path that our understanding of genetics can show so that farmers may obtain maximum yield from their fields? Is there a way to minimise the use of fertilisers and chemicals so that their harmful effects on the environment are reduced? Use of genetically modified crops is a possible solution.

Plants, bacteria, fungi and animals whose genes have been altered by manipulation are called **Genetically Modified Organisms (GMO)**. GM plants have been useful in many ways. Genetic modification has:

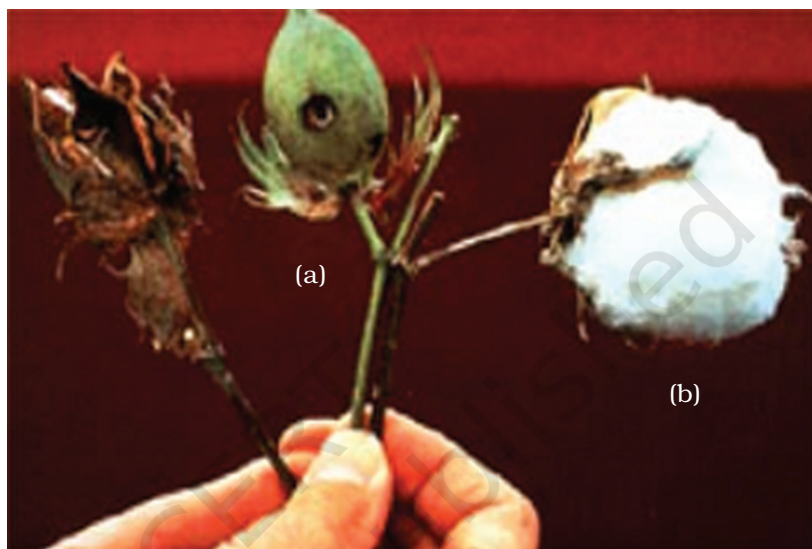
- (i) made crops more tolerant to abiotic stresses (cold, drought, salt, heat).
- (ii) reduced reliance on chemical pesticides (pest-resistant crops).
- (iii) helped to reduce post harvest losses.
- (iv) increased efficiency of mineral usage by plants (this prevents early exhaustion of fertility of soil).
- (v) enhanced nutritional value of food, e.g., golden rice, i.e., Vitamin 'A' enriched rice.

In addition to these uses, GM has been used to create tailor-made plants to supply alternative resources to industries, in the form of starches, fuels and pharmaceuticals.

Some of the applications of biotechnology in agriculture that you will study in detail are the production of pest resistant plants, which could decrease the amount of pesticide used. Bt toxin is produced by a bacterium called *Bacillus thuringiensis* (**Bt** for short). Bt toxin gene has been cloned from the bacteria and been expressed in plants to provide resistance to insects without the need for insecticides; in effect created a bio-pesticide. Examples are Bt cotton, Bt corn, rice, tomato, potato and soyabean etc.

**Bt Cotton:** Some strains of *Bacillus thuringiensis* produce proteins that kill certain insects such as lepidopterans (tobacco budworm, armyworm), coleopterans (beetles) and dipterans (flies, mosquitoes). *B. thuringiensis* forms protein crystals during a particular phase of their growth. These crystals contain a toxic **insecticidal protein**. Why does this toxin not kill the *Bacillus*? Actually, the Bt toxin protein exist as inactive *protoxins* but once an insect ingest the inactive toxin, it is converted into an active form of toxin due to the alkaline pH of the gut which solubilise the crystals. The activated toxin binds to the surface of midgut epithelial cells and create pores that cause cell swelling and lysis and eventually cause death of the insect.

Specific Bt toxin genes were isolated from *Bacillus thuringiensis* and incorporated into the several crop plants such as cotton (Figure 10.1). The choice of genes depends upon the crop and the targeted pest, as most Bt toxins are insect-group specific. The toxin is coded by a gene *cryIAc* named **cry**. There are a number of them, for example, the proteins encoded by the genes *cryIAc* and *cryIIAb* control the cotton bollworms, that of *cryIAb* controls corn borer.

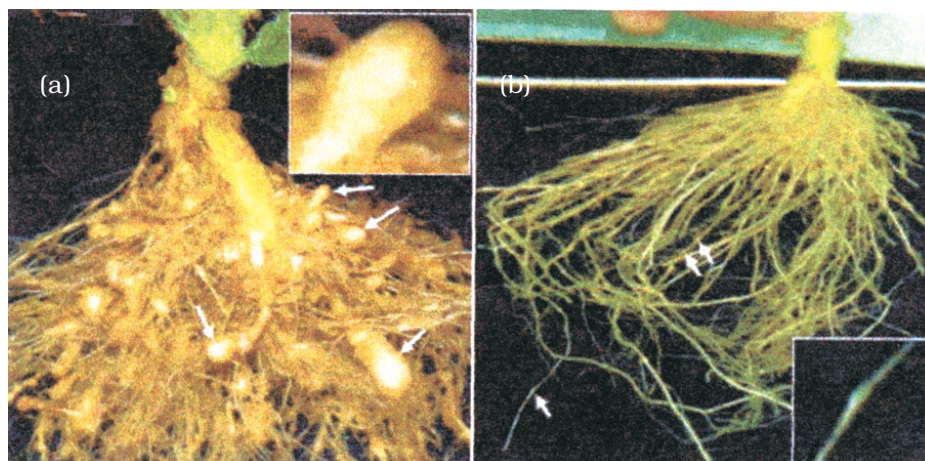


**Figure 10.1** Cotton boll: (a) destroyed by bollworms; (b) a fully mature cotton boll

**Pest Resistant Plants:** Several nematodes parasitise a wide variety of plants and animals including human beings. A nematode *Meloidogyne incognitia* infects the roots of tobacco plants and causes a great reduction in yield. A novel strategy was adopted to prevent this infestation which was based on the process of **RNA interference** (RNAi). RNAi takes place in all eukaryotic organisms as a method of cellular defense. This method involves silencing of a specific mRNA due to a complementary dsRNA molecule that binds to and prevents translation of the mRNA (silencing). The source of this complementary RNA could be from an infection by viruses having RNA genomes or mobile genetic elements (transposons) that replicate via an RNA intermediate.

Using *Agrobacterium* vectors, nematode-specific genes were introduced into the host plant (Figure 10.2). The introduction of DNA was such that it produced both sense and anti-sense RNA in the host cells. These two RNA's being complementary to each other formed a double stranded (dsRNA) that initiated RNAi and thus, silenced the specific mRNA of the nematode. The consequence was that the parasite could not survive in a transgenic host expressing specific interfering RNA. The transgenic plant therefore got itself protected from the parasite (Figure 10.2).





**Figure 10.2** Host plant-generated dsRNA triggers protection against nematode infestation: (a) Roots of a typical control plants; (b) transgenic plant roots 5 days after deliberate infection of nematode but protected through novel mechanism.

## 10.2 BIOTECHNOLOGICAL APPLICATIONS IN MEDICINE

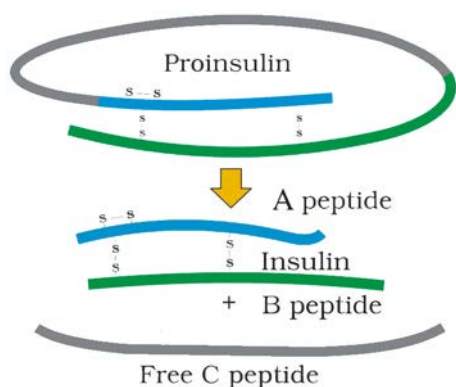
The recombinant DNA technological processes have made immense impact in the area of healthcare by enabling mass production of safe and more effective therapeutic drugs. Further, the recombinant therapeutics do not induce unwanted immunological responses as is common in case of similar products isolated from non-human sources. At present, about 30 recombinant therapeutics have been approved for human-use the world over. In India, 12 of these are presently being marketed.

### 10.2.1 Genetically Engineered Insulin

Management of adult-onset diabetes is possible by taking insulin at regular time intervals. *What would a diabetic patient do if enough human-insulin was not available?* If you discuss this, you would soon realise that one would have to isolate and use insulin from other animals. *Would the insulin isolated from other animals be just as effective as that secreted by the human body itself and would it not elicit an immune response in the human body?* Now, imagine if bacterium were available that could make human insulin. Suddenly the whole process becomes so simple. You can easily grow a large quantity of the bacteria and make as much insulin as you need.

*Think about whether insulin can be orally administered to diabetic people or not. Why?*

Insulin used for diabetes was earlier extracted from pancreas of slaughtered cattle and pigs. Insulin from an animal source, though caused some patients to develop allergy or other types of reactions to the foreign protein. Insulin consists of two short polypeptide chains: chain A and chain B, that are linked together by disulphide bridges (Figure 10.3).



**Figure 10.3** Maturation of pro-insulin into insulin (simplified)

In mammals, including humans, insulin is synthesised as a pro-hormone (like a pro-enzyme, the pro-hormone also needs to be processed before it becomes a fully mature and functional hormone) which contains an extra stretch called the **C peptide**. This C peptide is not present in the mature insulin and is removed during maturation into insulin. The main challenge for production of insulin using rDNA techniques was getting insulin assembled into a mature form. In 1983, Eli Lilly an American company prepared two DNA sequences corresponding to A and B, chains of human insulin and introduced them in plasmids of *E. coli* to produce insulin chains. Chains A and B were produced separately, extracted and combined by creating disulfide bonds to form human insulin.

### 10.2.2 Gene Therapy

If a person is born with a hereditary disease, can a corrective therapy be taken for such a disease? Gene therapy is an attempt to do this. Gene therapy is a collection of methods that allows correction of a gene defect that has been diagnosed in a child/embryo. Here genes are inserted into a person's cells and tissues to treat a disease. Correction of a genetic defect involves delivery of a normal gene into the individual or embryo to take over the function of and compensate for the non-functional gene.

The first clinical gene therapy was given in 1990 to a 4-year old girl with adenosine deaminase (ADA) deficiency. This enzyme is crucial for the immune system to function. The disorder is caused due to the deletion of the gene for adenosine deaminase. In some children ADA deficiency can be cured by bone marrow transplantation; in others it can be treated by enzyme replacement therapy, in which functional ADA is given to the patient by injection. But the problem with both of these approaches that they are not completely curative. As a first step towards gene therapy, lymphocytes from the blood of the patient are grown in a culture outside the body. A functional ADA cDNA (using a retroviral vector) is then introduced into these lymphocytes, which are subsequently returned to the patient. However, as these cells are not immortal, the patient requires periodic infusion of such genetically engineered lymphocytes. However, if the gene isolate from marrow cells producing ADA is introduced into cells at early embryonic stages, it could be a permanent cure.

### 10.2.3 Molecular Diagnosis

You know that for effective treatment of a disease, early diagnosis and understanding its pathophysiology is very important. Using conventional methods of diagnosis (serum and urine analysis, etc.) early detection is



not possible. Recombinant DNA technology, Polymerase Chain Reaction (PCR) and Enzyme Linked Immuno-sorbent Assay (ELISA) are some of the techniques that serve the purpose of early diagnosis.

Presence of a pathogen (bacteria, viruses, etc.) is normally suspected only when the pathogen has produced a disease symptom. By this time the concentration of pathogen is already very high in the body. However, very low concentration of a bacteria or virus (at a time when the symptoms of the disease are not yet visible) can be detected by amplification of their nucleic acid by PCR. *Can you explain how PCR can detect very low amounts of DNA?* PCR is now routinely used to detect HIV in suspected AIDS patients. It is being used to detect mutations in genes in suspected cancer patients too. It is a powerful technique to identify many other genetic disorders.

A single stranded DNA or RNA, tagged with a radioactive molecule (probe) is allowed to hybridise to its complementary DNA in a clone of cells followed by detection using autoradiography. The clone having the mutated gene will hence not appear on the photographic film, because the probe will not have complementarity with the mutated gene.

ELISA is based on the principle of antigen-antibody interaction. Infection by pathogen can be detected by the presence of antigens (proteins, glycoproteins, etc.) or by detecting the antibodies synthesised against the pathogen.

### 10.3 TRANSGENIC ANIMALS

Animals that have had their DNA manipulated to possess and express an extra (foreign) gene are known as **transgenic animals**. Transgenic rats, rabbits, pigs, sheep, cows and fish have been produced, although over 95 per cent of all existing transgenic animals are mice. *Why are these animals being produced? How can man benefit from such modifications?* Let us try and explore some of the common reasons:

- (i) **Normal physiology and development:** Transgenic animals can be specifically designed to allow the study of how genes are regulated, and how they affect the normal functions of the body and its development, e.g., study of complex factors involved in growth such as insulin-like growth factor. By introducing genes from other species that alter the formation of this factor and studying the biological effects that result, information is obtained about the biological role of the factor in the body.
- (ii) **Study of disease:** Many transgenic animals are designed to increase our understanding of how genes contribute to the development of disease. These are specially made to serve as models for human diseases so that investigation of new treatments for diseases is made possible. Today transgenic models exist for many human diseases such as cancer, cystic fibrosis, rheumatoid arthritis and Alzheimer's.



- (iii) **Biological products:** Medicines required to treat certain human diseases can contain biological products, but such products are often expensive to make. Transgenic animals that produce useful biological products can be created by the introduction of the portion of DNA (or genes) which codes for a particular product such as human protein ( $\alpha$ -1-antitrypsin) used to treat emphysema. Similar attempts are being made for treatment of phenylketonuria (PKU) and cystic fibrosis. In 1997, the first transgenic cow, Rosie, produced human protein-enriched milk (2.4 grams per litre). The milk contained the human alpha-lactalbumin and was nutritionally a more balanced product for human babies than natural cow-milk.
- (iv) **Vaccine safety:** Transgenic mice are being developed for use in testing the safety of vaccines before they are used on humans. Transgenic mice are being used to test the safety of the polio vaccine. If successful and found to be reliable, they could replace the use of monkeys to test the safety of batches of the vaccine.
- (v) **Chemical safety testing:** This is known as toxicity/safety testing. The procedure is the same as that used for testing toxicity of drugs. Transgenic animals are made that carry genes which make them more sensitive to toxic substances than non-transgenic animals. They are then exposed to the toxic substances and the effects studied. Toxicity testing in such animals will allow us to obtain results in less time.

#### 10.4 ETHICAL ISSUES

The manipulation of living organisms by the human race cannot go on any further, without regulation. Some ethical standards are required to evaluate the morality of all human activities that might help or harm living organisms.

Going beyond the morality of such issues, the biological significance of such things is also important. Genetic modification of organisms can have unpredictable results when such organisms are introduced into the ecosystem.

Therefore, the Indian Government has set up organisations such as **GEAC** (Genetic Engineering Approval Committee), which will make decisions regarding the validity of GM research and the safety of introducing GM-organisms for public services.

The modification/usage of living organisms for public services (as food and medicine sources, for example) has also created problems with patents granted for the same.

There is growing public anger that certain companies are being granted patents for products and technologies that make use of the genetic materials, plants and other biological resources that have long been identified, developed and used by farmers and indigenous people of a specific region/country.



Rice is an important food grain, the presence of which goes back thousands of years in Asia's agricultural history. There are an estimated 200,000 varieties of rice in India alone. The diversity of rice in India is one of the richest in the world. Basmati rice is distinct for its unique aroma and flavour and 27 documented varieties of Basmati are grown in India. There is reference to Basmati in ancient texts, folklore and poetry, as it has been grown for centuries. In 1997, an American company got patent rights on Basmati rice through the US Patent and Trademark Office. This allowed the company to sell a 'new' variety of Basmati, in the US and abroad. This 'new' variety of Basmati had actually been derived from Indian farmer's varieties. Indian Basmati was crossed with semi-dwarf varieties and claimed as an invention or a novelty. The patent extends to functional equivalents, implying that other people selling Basmati rice could be restricted by the patent. Several attempts have also been made to patent uses, products and processes based on Indian traditional herbal medicines, e.g., turmeric neem. If we are not vigilant and we do not immediately counter these patent applications, other countries/individuals may encash on our rich legacy and we may not be able to do anything about it.

**Biopiracy** is the term used to refer to the use of bio-resources by multinational companies and other organisations without proper authorisation from the countries and people concerned without compensatory payment.

Most of the industrialised nations are rich financially but poor in biodiversity and traditional knowledge. In contrast the developing and the underdeveloped world is rich in biodiversity and traditional knowledge related to bio-resources. Traditional knowledge related to bio-resources can be exploited to develop modern applications and can also be used to save time, effort and expenditure during their commercialisation.

There has been growing realisation of the injustice, inadequate compensation and benefit sharing between developed and developing countries. Therefore, some nations are developing laws to prevent such unauthorised exploitation of their bio-resources and traditional knowledge.

The Indian Parliament has recently cleared the second amendment of the Indian Patents Bill, that takes such issues into consideration, including patent terms emergency provisions and research and development initiative.



## SUMMARY

Biotechnology has given to humans several useful products by using microbes, plant, animals and their metabolic machinery. Techniques of tissue culture and somatic hybridisation offer vast potential for manipulation of plants *in vitro* to produce new varieties. Recombinant DNA technology has made it possible to engineer microbes, plants and animals such that they have novel capabilities. Genetically Modified Organisms have been created by using methods other than natural methods to transfer one or more genes from one organism to another, generally using techniques such as recombinant DNA technology.

GM plants have been useful in increasing crop yields, reduce post-harvest losses and make crops more tolerant of stresses. There are several GM crop plants with improved nutritional value of foods and reduced the reliance on chemical pesticides (pest-resistant crops).

Recombinant DNA technological processes have made immense impact in the area of healthcare by enabling mass production of safe and more effective therapeutics. Since the recombinant therapeutics are identical to human proteins, they do not induce unwanted immunological responses and are free from risk of infection as was observed in case of similar products isolated from non-human sources. Human insulin is made in bacteria yet its structure is absolutely identical to that of the natural molecule.

Transgenic animals are also used to understand how genes contribute to the development of a disease by serving as models for human diseases, such as cancer, cystic fibrosis, rheumatoid arthritis and Alzheimer's.

Gene therapy is the insertion of genes into an individual's cells and tissues to treat diseases especially hereditary diseases. It does so by replacing a defective mutant allele with a functional one or gene targeting which involves gene amplification. Viruses that attack their hosts and introduce their genetic material into the host cell as part of their replication cycle are used as vectors to transfer healthy genes or more recently portions of genes.

The current interest in the manipulation of microbes, plants, and animals has raised serious ethical questions.



## EXERCISES

1. Which part of the plant is best suited for making virus-free plants and why?
2. What is the major advantage of producing plants by micropropagation?
3. Find out what the various components of the medium used for propagation of an explant *in vitro* are?
4. Crystals of Bt toxin produced by some bacteria do not kill the bacteria themselves because –
  - (a) bacteria are resistant to the toxin



- (b) toxin is immature;
  - (c) toxin is inactive;
  - (d) bacteria encloses toxin in a special sac.
5. What are transgenic bacteria? Illustrate using any one example.
  6. Compare and contrast the advantages and disadvantages of production of genetically modified crops.
  7. What are Cry proteins? Name an organism that produce it. How has man exploited this protein to his benefit?
  8. What is gene therapy? Illustrate using the example of adenosine deaminase (ADA) deficiency.
  9. Diagrammatically represent the experimental steps in cloning and expressing an human gene (say the gene for growth hormone) into a bacterium like *E. coli*?
  10. Can you suggest a method to remove oil (hydrocarbon) from seeds based on your understanding of rDNA technology and chemistry of oil?
  11. Find out from internet what is golden rice.
  12. Does our blood have proteases and nucleases?
  13. Consult internet and find out how to make orally active protein pharmaceutical. What is the major problem to be encountered?
- 
-

# UNIT X

# ECOLOGY

## **Chapter 11**

Organisms and Populations

## **Chapter 12**

Ecosystem

## **Chapter 13**

Biodiversity and Conservation

Diversity is not only a characteristic of living organisms but also of content in biology textbooks. Biology is presented either as botany, zoology and microbiology or as classical and modern. The latter is a euphemism for molecular aspects of biology. Luckily we have many threads which weave the different areas of biological information into a unifying principle. Ecology is one such thread which gives us a holistic perspective to biology. The essence of biological understanding is to know how organisms, while remaining an individual, interact with other organisms and physical habitats as a group and hence behave like organised wholes, i.e., population, community, ecosystem or even as the whole biosphere. Ecology explains to us all this. A particular aspect of this is the study of anthropogenic environmental degradation and the socio-political issues it has raised. This unit describes as well as takes a critical view of the above aspects.







RAMDEO MISRA  
(1908-1998)

Ramdeo Misra is revered as the Father of Ecology in India. Born on 26 August 1908, Ramdeo Misra obtained Ph.D in Ecology (1937) under Prof. W. H. Pearsall, FRS, from Leeds University in UK. He established teaching and research in ecology at the Department of Botany of the Banaras Hindu University, Varanasi. His research laid the foundations for understanding of tropical communities and their succession, environmental responses of plant populations and productivity and nutrient cycling in tropical forest and grassland ecosystems. Misra formulated the first postgraduate course in ecology in India. Over 50 scholars obtained Ph. D degree under his supervision and moved on to other universities and research institutes to initiate ecology teaching and research across the country.

He was honoured with the Fellowships of the Indian National Science Academy and World Academy of Arts and Science, and the prestigious Sanjay Gandhi Award in Environment and Ecology. Due to his efforts, the Government of India established the National Committee for Environmental Planning and Coordination (1972) which, in later years, paved the way for the establishment of the Ministry of Environment and Forests (1984).

# CHAPTER 11



# ORGANISMS AND POPULATIONS

## 11.1 Populations

Our living world is fascinatingly diverse and amazingly complex. We can try to understand its complexity by investigating processes at various levels of biological organisation—macromolecules, cells, tissues, organs, individual organisms, population, communities, ecosystems and biomes. At any level of biological organisation we can ask two types of questions – for example, when we hear the bulbul singing early morning in the garden, we may ask – ‘How does the bird sing?’ Or, ‘Why does the bird sing?’ The ‘how-type’ questions seek the *mechanism* behind the process while the ‘why-type’ questions seek the *significance* of the process. For the first question in our example, the answer might be in terms of the operation of the voice box and the vibrating bone in the bird, whereas for the second question the answer may lie in the bird’s need to communicate with its mate during breeding season. When you observe nature around you with a scientific frame of mind you will certainly come up with many interesting questions of both types - *Why are night-blooming flowers generally white? How does the bee know which flower has nectar? Why does cactus have so many thorns? How does the chick spurs recognise her own mother?*, and so on.



You have already learnt in previous classes that Ecology is a subject which studies the interactions among organisms and between the organism and its physical (abiotic) environment.

Ecology is basically concerned with four levels of biological organisation – organisms, populations, communities and biomes. In this chapter we explore ecology at population levels.

## 11.1 POPULATIONS

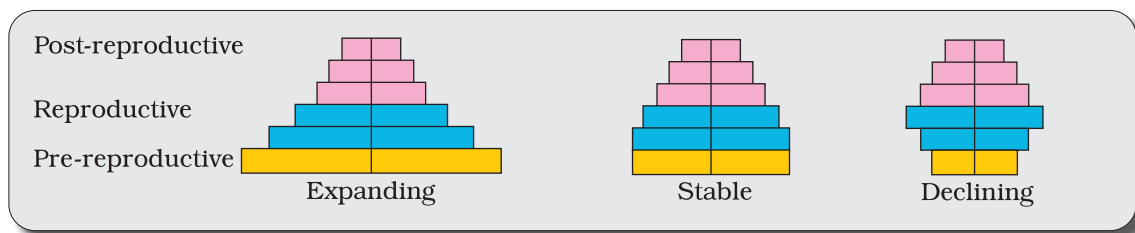
### 11.1.1 Population Attributes

In nature, we rarely find isolated, single individuals of any species; majority of them live in groups in a well defined geographical area, share or compete for similar resources, potentially interbreed and thus constitute a population. Although the term interbreeding implies sexual reproduction, a group of individuals resulting from even asexual reproduction is also generally considered a population for the purpose of ecological studies. All the cormorants in a wetland, rats in an abandoned dwelling, teakwood trees in a forest tract, bacteria in a culture plate and lotus plants in a pond, are some examples of a population. In earlier chapters you have learnt that although an individual organism is the one that has to cope with a changed environment, it is at the population level that natural selection operates to evolve the desired traits. Population ecology is, therefore, an important area because it links ecology to population genetics and evolution.

A population has certain attributes whereas, an individual organism does not. An individual may have births and deaths, but a population has *birth rates* and *death rates*. In a population these rates refer to *per capita* births and deaths. The rates, hence, expressed are change in numbers (increase or decrease) with respect to members of the population. Here is an example. If in a pond there were 20 lotus plants last year and through reproduction 8 new plants are added, taking the current population to 28, we calculate the birth rate as  $8/20 = 0.4$  offspring per lotus per year. If 4 individuals in a laboratory population of 40 fruitflies died during a specified time interval, say a week, the death rate in the population during that period is  $4/40 = 0.1$  individuals per fruitfly per week.

Another attribute characteristic of a population is *sex ratio*. An individual is either a male or a female but a population has a sex ratio (e.g., 60 per cent of the population are females and 40 per cent males).

A population at any given time is composed of individuals of different ages. If the age distribution (per cent individuals of a given age or age group) is plotted for the population, the resulting structure is called an age pyramid (Figure 11.1). For human population, the age pyramids generally show age distribution of males and females in a diagram. The shape of the pyramids reflects the growth status of the population - (a) whether it is growing, (b) stable or (c) declining.



**Figure 11.1** Representation of age pyramids for human population

The size of the population tells us a lot about its status in the habitat. Whatever ecological processes we wish to investigate in a population, be it the outcome of competition with another species, the impact of a predator or the effect of a pesticide application, we always evaluate them in terms of any change in the population size. The size, in nature, could be as low as <10 (Siberian cranes at Bharatpur wetlands in any year) or go into millions (*Chlamydomonas* in a pond). Population size, technically called **population density** (designated as  $N$ ), need not necessarily be measured in numbers only. Although total number is generally the most appropriate measure of population density, it is in some cases either meaningless or difficult to determine. In an area, if there are 200 carrot grass (*Parthenium hysterophorus*) plants but only a single huge banyan tree with a large canopy, stating that the population density of banyan is low relative to that of carrot grass amounts to underestimating the enormous role of the Banyan in that community. In such cases, the per cent cover or biomass is a more meaningful measure of the population size. Total number is again not an easily adoptable measure if the population is huge and counting is impossible or very time-consuming. *If you have a dense laboratory culture of bacteria in a petri dish what is the best measure to report its density?* Sometimes, for certain ecological investigations, there is no need to know the absolute population densities; relative densities serve the purpose equally well. For instance, the number of fish caught per trap is good enough measure of its total population density in the lake. We are mostly obliged to estimate population sizes indirectly, without actually counting them or seeing them. The tiger census in our national parks and tiger reserves is often based on pug marks and fecal pellets.

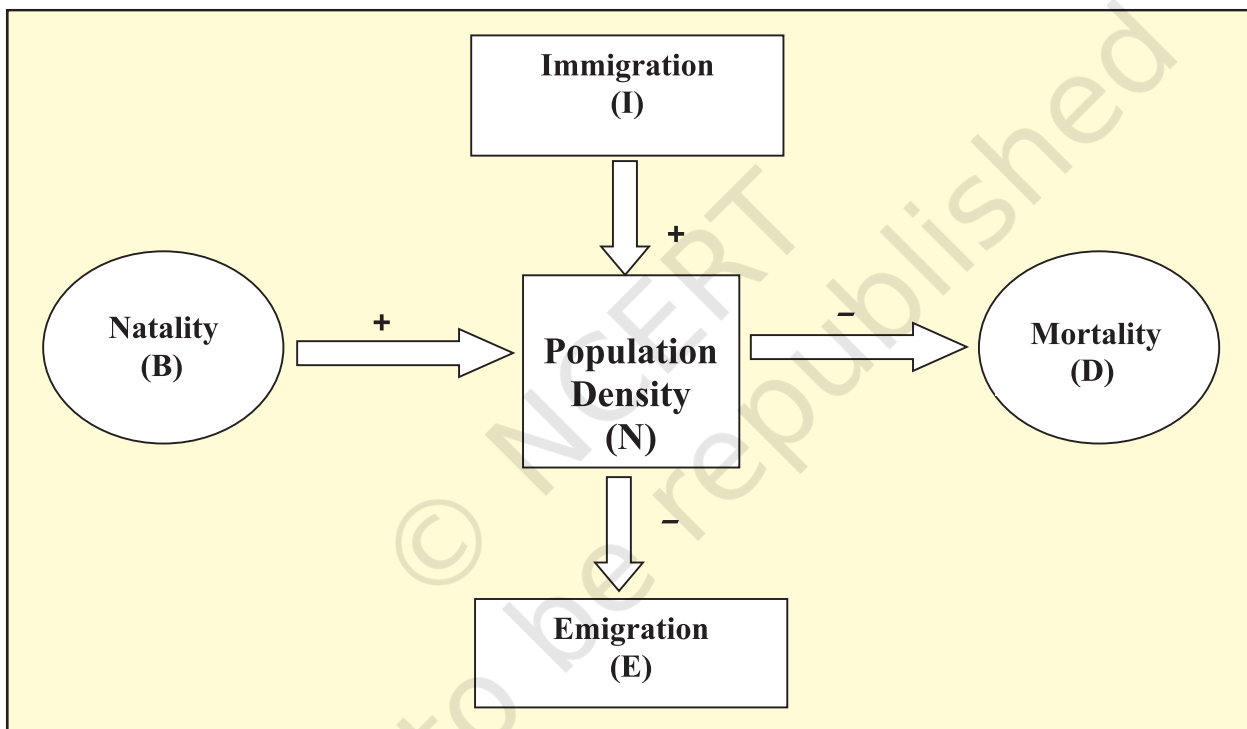
### 11.1.2 Population Growth

The size of a population for any species is not a static parameter. It keeps changing with time, depending on various factors including food availability, predation pressure and adverse weather. In fact, it is these changes in population density that give us some idea of what is happening to the population – whether it is flourishing or declining. Whatever might be the ultimate reasons, the density of a population in a given habitat during a given period, fluctuates due to changes in four basic processes,



two of which (natality and immigration) contribute to an increase in population density and two (mortality and emigration) to a decrease.

- (i) **Natality** refers to the number of births during a given period in the population that are added to the initial density.
- (ii) **Mortality** is the number of deaths in the population during a given period.
- (iii) **Immigration** is the number of individuals of the same species that have come into the habitat from elsewhere during the time period under consideration.
- (iv) **Emigration** is the number of individuals of the population who left the habitat and gone elsewhere during the time period under consideration.



**Figure 11.2**

So, if  $N$  is the population density at time  $t$ , then its density at time  $t + 1$  is

$$N_{t+1} = N_t + [(B + I) - (D + E)]$$

You can see from the above equation (Fig. 11.2) that population density will increase if the number of births plus the number of immigrants ( $B + I$ ) is more than the number of deaths plus the number of emigrants ( $D + E$ ). Under normal conditions, births and deaths are the most important factors influencing population density, the other two factors assuming importance only under special conditions. For instance, if a new habitat is just being colonised, immigration may contribute more significantly to population growth than birth rates.

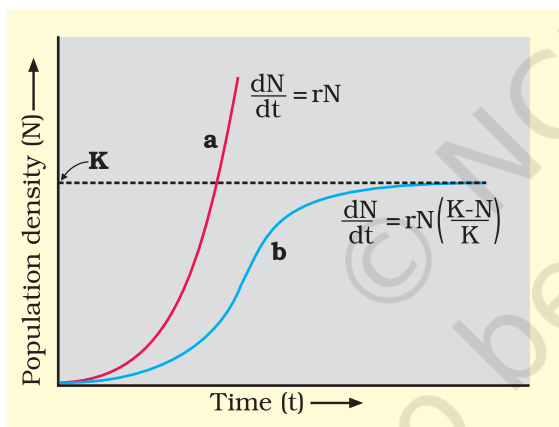
**Growth Models** : Does the growth of a population with time show any specific and predictable pattern? We have been concerned about unbridled human population growth and problems created by it in our country and it is therefore natural for us to be curious if different animal populations in nature behave the same way or show some restraints on growth. Perhaps we can learn a lesson or two from nature on how to control population growth.

- (i) **Exponential growth**: Resource (food and space) availability is obviously essential for the unimpeded growth of a population. Ideally, when resources in the habitat are unlimited, each species has the ability to realise fully its innate potential to grow in number, as Darwin observed while developing his theory of natural selection. Then the population grows in an exponential or geometric fashion. If in a population of size  $N$ , the birth rates (not total number but *per capita* births) are represented as  $b$  and death rates (again, *per capita* death rates) as  $d$ , then the increase or decrease in  $N$  during a unit time period  $t$  ( $dN/dt$ ) will be

$$dN/dt = (b - d) \times N$$

$$\text{Let } (b-d) = r, \text{ then}$$

$$dN/dt = rN$$



**Figure 11.3** Population growth curve **a** when responses are not limiting the growth, plot is exponential, **b** when responses are limiting the growth, plot is logistic, **K** is carrying capacity

The  $r$  in this equation is called the 'intrinsic rate of natural increase' and is a very important parameter chosen for assessing impacts of any biotic or abiotic factor on population growth.

To give you some idea about the magnitude of  $r$  values, for the Norway rat the  $r$  is 0.015, and for the flour beetle it is 0.12. In 1981, the  $r$  value for human population in India was 0.0205. *Find out what the current  $r$  value is. For calculating it, you need to know the birth rates and death rates.*

The above equation describes the exponential or geometric growth pattern of a population (Figure 11.3) and results in a J-shaped curve when we plot  $N$  in relation to time. If you are familiar with basic calculus, you can derive the integral form of the exponential growth equation as

$$N_t = N_0 e^{rt}$$

where

$N_t$  = Population density after time  $t$

$N_0$  = Population density at time zero

$r$  = intrinsic rate of natural increase

$e$  = the base of natural logarithms (2.71828)

Any species growing exponentially under unlimited resource conditions can reach enormous population densities in a short time.



Darwin showed how even a slow growing animal like elephant could reach enormous numbers in the absence of checks. The following is an anecdote popularly narrated to demonstrate dramatically how fast a huge population could build up when growing exponentially.

*The king and the minister sat for a chess game. The king, confident of winning the game, was ready to accept any bet proposed by the minister. The minister humbly said that if he won, he wanted only some wheat grains, the quantity of which is to be calculated by placing on the chess board one grain in Square 1, then two in Square 2, then four in Square 3, and eight in Square 4, and so on, doubling each time the previous quantity of wheat on the next square until all the 64 squares were filled. The king accepted the seemingly silly bet and started the game, but unluckily for him, the minister won. The king felt that fulfilling the minister's bet was so easy. He started with a single grain on the first square and proceeded to fill the other squares following minister's suggested procedure, but by the time he covered half the chess board, the king realised to his dismay that all the wheat produced in his entire kingdom pooled together would still be inadequate to cover all the 64 squares. Now think of a tiny Paramecium starting with just one individual and through binary fission, doubling in numbers every day, and imagine what a mind-boggling population size it would reach in 64 days. (provided food and space remain unlimited)*

- (ii) **Logistic growth:** No population of any species in nature has at its disposal unlimited resources to permit exponential growth. This leads to competition between individuals for limited resources. Eventually, the 'fittest' individual will survive and reproduce. The governments of many countries have also realised this fact and introduced various restraints with a view to limit human population growth. In nature, a given habitat has enough resources to support a maximum possible number, beyond which no further growth is possible. Let us call this limit as nature's *carrying capacity* (K) for that species in that habitat.

A population growing in a habitat with limited resources show initially a lag phase, followed by phases of acceleration and deceleration and finally an asymptote, when the population density reaches the carrying capacity. A plot of N in relation to time (t) results in a sigmoid curve. This type of population growth is called *Verhulst-Pearl Logistic Growth* (Figure 11.3) and is described by the following equation:

$$dN/dt = rN \left( \frac{K - N}{K} \right)$$



Where  $N$  = Population density at time  $t$   
 $r$  = Intrinsic rate of natural increase  
 $K$  = Carrying capacity

Since resources for growth for most animal populations are finite and become limiting sooner or later, the logistic growth model is considered a more realistic one.

*Gather from Government Census data the population figures for India for the last 100 years, plot them and check which growth pattern is evident.*

### 11.1.3 Life History Variation

Populations evolve to maximise their reproductive fitness, also called Darwinian fitness (high  $r$  value), in the habitat in which they live. Under a particular set of selection pressures, organisms evolve towards the most efficient reproductive strategy. Some organisms breed only once in their lifetime (Pacific salmon fish, bamboo) while others breed many times during their lifetime (most birds and mammals). Some produce a large number of small-sized offspring (Oysters, pelagic fishes) while others produce a small number of large-sized offspring (birds, mammals). So, which is desirable for maximising fitness? Ecologists suggest that life history traits of organisms have evolved in relation to the constraints imposed by the abiotic and biotic components of the habitat in which they live. Evolution of life history traits in different species is currently an important area of research being conducted by ecologists.

### 11.1.4 Population Interactions

Can you think of any natural habitat on earth that is inhabited just by a single species? There is no such habitat and such a situation is even inconceivable. For any species, the minimal requirement is one more species on which it can feed. Even a plant species, which makes its own food, cannot survive alone; it needs soil microbes to break down the organic matter in soil and return the inorganic nutrients for absorption. And then, how will the plant manage pollination without an animal agent? It is obvious that in nature, animals, plants and microbes do not and cannot live in isolation but interact in various ways to form a biological community. Even in minimal communities, many interactive linkages exist, although all may not be readily apparent.

Interspecific interactions arise from the interaction of populations of two different species. They could be beneficial, detrimental or neutral (neither harm nor benefit) to one of the species or both. Assigning a '+' sign for beneficial interaction, '-' sign for detrimental and 0 for neutral interaction, let us look at all the possible outcomes of interspecific interactions (Table 11.1).



**Table 11.1 : Population Interactions**

Species A	Species B	Name of Interaction
+	+	<i>Mutualism</i>
-	-	<i>Competition</i>
+	-	<i>Predation</i>
+	-	<i>Parasitism</i>
+	0	<i>Commensalism</i>
-	0	<i>Amensalism</i>

Both the species benefit in **mutualism** and both lose in **competition** in their interactions with each other. In both **parasitism** and **predation** only one species benefits (parasite and predator, respectively) and the interaction is detrimental to the other species (host and prey, respectively). The interaction where one species is benefitted and the other is neither benefitted nor harmed is called **commensalism**. In **amensalism** on the other hand one species is harmed whereas the other is unaffected. Predation, parasitism and commensalism share a common characteristic– the interacting species live closely together.

- (i) **Predation:** What would happen to all the energy fixed by autotrophic organisms if the community has no animals to eat the plants? You can think of predation as nature's way of transferring to higher trophic levels the energy fixed by plants. When we think of predator and prey, most probably it is the tiger and the deer that readily come to our mind, but a sparrow eating any seed is no less a predator. Although animals eating plants are categorised separately as *herbivores*, they are, in a broad ecological context, not very different from predators.

Besides acting as 'conduits' for energy transfer across trophic levels, predators play other important roles. They keep prey populations under control. But for predators, prey species could achieve very high population densities and cause ecosystem instability. When certain exotic species are introduced into a geographical area, they become invasive and start spreading fast because the invaded land does not have its natural predators. The prickly pear cactus introduced into Australia in the early 1920's caused havoc by spreading rapidly into millions of hectares of rangeland. Finally, the invasive cactus was brought under control only after a cactus-feeding predator (a moth) from its natural habitat was introduced into the country. *Biological control* methods adopted in agricultural pest control are based on the ability of the predator



to regulate prey population. Predators also help in maintaining species diversity in a community, by reducing the intensity of competition among competing prey species. In the rocky intertidal communities of the American Pacific Coast the starfish *Pisaster* is an important predator. In a field experiment, when all the starfish were removed from an enclosed intertidal area, more than 10 species of invertebrates became extinct within a year, because of inter-specific competition.

If a predator is too efficient and overexploits its prey, then the prey might become extinct and following it, the predator will also become extinct for lack of food. This is the reason why predators in nature are 'prudent'. Prey species have evolved various defenses to lessen the impact of predation. Some species of insects and frogs are cryptically-coloured (*camouflaged*) to avoid being detected easily by the predator. Some are poisonous and therefore avoided by the predators. The Monarch butterfly is highly distasteful to its predator (bird) because of a special chemical present in its body. Interestingly, the butterfly acquires this chemical during its caterpillar stage by feeding on a poisonous weed.

For plants, herbivores are the predators. Nearly 25 per cent of all insects are known to be *phytophagous* (feeding on plant sap and other parts of plants). The problem is particularly severe for plants because, unlike animals, they cannot run away from their predators. Plants therefore have evolved an astonishing variety of morphological and chemical defences against herbivores. Thorns (*Acacia*, *Cactus*) are the most common morphological means of defence. Many plants produce and store chemicals that make the herbivore sick when they are eaten, inhibit feeding or digestion, disrupt its reproduction or even kill it. You must have seen the weed *Calotropis* growing in abandoned fields. The plant produces highly poisonous cardiac glycosides and that is why you never see any cattle or goats browsing on this plant. A wide variety of chemical substances that we extract from plants on a commercial scale (nicotine, caffeine, quinine, strychnine, opium, etc..) are produced by them actually as defences against grazers and browsers.

- (ii) **Competition:** When Darwin spoke of the struggle for existence and survival of the fittest in nature, he was convinced that interspecific competition is a potent force in organic evolution. It is generally believed that competition occurs when closely related species compete for the same resources that are limiting, but this is not entirely true. Firstly, totally unrelated species could also compete for the same resource. For instance, in some shallow South American lakes, visiting flamingoes and resident fishes compete for their common food, the zooplankton in the lake. Secondly,



resources need not be limiting for competition to occur; in interference competition, the feeding efficiency of one species might be reduced due to the interfering and inhibitory presence of the other species, even if resources (food and space) are abundant. Therefore, competition is best defined as a process in which the fitness of one species (measured in terms of its 'r' the intrinsic rate of increase) is significantly lower in the presence of another species. It is relatively easy to demonstrate in laboratory experiments, as Gause and other experimental ecologists did, when resources are limited the competitively superior species will eventually eliminate the other species, but evidence for such competitive exclusion occurring in nature is not always conclusive. Strong and persuasive circumstantial evidence does exist however in some cases. The Abingdon tortoise in Galapagos Islands became extinct within a decade after goats were introduced on the island, apparently due to the greater browsing efficiency of the goats. Another evidence for the occurrence of competition in nature comes from what is called 'competitive release'. A species whose distribution is restricted to a small geographical area because of the presence of a competitively superior species, is found to expand its distributional range dramatically when the competing species is experimentally removed. Connell's elegant field experiments showed that on the rocky sea coasts of Scotland, the larger and competitively superior barnacle *Balanus* dominates the intertidal area, and excludes the smaller barnacle *Chathamalus* from that zone. In general, herbivores and plants appear to be more adversely affected by competition than carnivores.

Gause's '*Competitive Exclusion Principle*' states that two closely related species competing for the same resources cannot co-exist indefinitely and the competitively inferior one will be eliminated eventually. This may be true if resources are limiting, but not otherwise. More recent studies do not support such gross generalisations about competition. While they do not rule out the occurrence of interspecific competition in nature, they point out that species facing competition might evolve mechanisms that promote co-existence rather than exclusion. One such mechanism is 'resource partitioning'. If two species compete for the same resource, they could avoid competition by choosing, for instance, different times for feeding or different foraging patterns. MacArthur showed that five closely related species of warblers living on the same tree were able to avoid competition and co-exist due to behavioural differences in their foraging activities.

- (iii) **Parasitism:** Considering that the parasitic mode of life ensures free lodging and meals, it is not surprising that parasitism has



evolved in so many taxonomic groups from plants to higher vertebrates. Many parasites have evolved to be host-specific (they can parasitise only a single species of host) in such a way that both host and the parasite tend to co-evolve; that is, if the host evolves special mechanisms for rejecting or resisting the parasite, the parasite has to evolve mechanisms to counteract and neutralise them, in order to be successful with the same host species. In accordance with their life styles, parasites evolved special adaptations such as the loss of unnecessary sense organs, presence of adhesive organs or suckers to cling on to the host, loss of digestive system and high reproductive capacity. The life cycles of parasites are often complex, involving one or two intermediate hosts or vectors to facilitate parasitisation of its primary host. The human liver fluke (a trematode parasite) depends on two intermediate hosts (a snail and a fish) to complete its life cycle. The malarial parasite needs a vector (mosquito) to spread to other hosts. Majority of the parasites harm the host; they may reduce the survival, growth and reproduction of the host and reduce its population density. They might render the host more vulnerable to predation by making it physically weak. *Do you believe that an ideal parasite should be able to thrive within the host without harming it? Then why didn't natural selection lead to the evolution of such totally harmless parasites?*

Parasites that feed on the external surface of the host organism are called *ectoparasites*. The most familiar examples of this group are the lice on humans and ticks on dogs. Many marine fish are infested with ectoparasitic copepods. *Cuscuta*, a parasitic plant that is commonly found growing on hedge plants, has lost its chlorophyll and leaves in the course of evolution. It derives its nutrition from the host plant which it parasitises. The female mosquito is not considered a parasite, although it needs our blood for reproduction. *Can you explain why?*

In contrast, *endoparasites* are those that live inside the host body at different sites (liver, kidney, lungs, red blood cells, etc.). The life cycles of endoparasites are more complex because of their extreme specialisation. Their morphological and anatomical features are greatly simplified while emphasising their reproductive potential.

*Brood parasitism* in birds is a fascinating example of parasitism in which the parasitic bird lays its eggs in the nest of its host and lets the host incubate them. During the course of evolution, the eggs of the parasitic bird have evolved to resemble the host's egg in size and colour to reduce the chances of the host



bird detecting the foreign eggs and ejecting them from the nest. Try to follow the movements of the cuckoo (koel) and the crow in your neighborhood park during the breeding season (spring to summer) and watch brood parasitism in action.

- (iv) **Commensalism:** This is the interaction in which one species benefits and the other is neither harmed nor benefited. An orchid growing as an *epiphyte* on a mango branch, and barnacles growing on the back of a whale benefit while neither the mango tree nor the whale derives any apparent benefit. The cattle egret and grazing cattle in close association, a sight you are most likely to catch if you live in farmed rural areas, is a classic example of commensalism. The egrets always forage close to where the cattle are grazing because the cattle, as they move, stir up and flush out insects from the vegetation that otherwise might be difficult for the egrets to find and catch. Another example of commensalism is the interaction between sea anemone that has stinging tentacles and the clown fish that lives among them. The fish gets protection from predators which stay away from the stinging tentacles. The anemone does not appear to derive any benefit by hosting the clown fish.



**Figure 11.4** Mutual relationship between fig tree and wasp: (a) Fig flower is pollinated by wasp; (b) Wasp laying eggs in a fig fruit

- (v) **Mutualism:** This interaction confers benefits on both the interacting species. Lichens represent an intimate mutualistic relationship between a fungus and photosynthesising algae or cyanobacteria. Similarly, the *mycorrhizae* are associations between fungi and the roots of higher plants. The fungi help the plant in the absorption of essential nutrients from the soil while the plant in turn provides the fungi with energy-yielding carbohydrates.

The most spectacular and evolutionarily fascinating examples of mutualism are found in plant-animal relationships. Plants need the help of animals for pollinating their flowers and dispersing their seeds. Animals obviously have to be paid 'fees' for the services that plants expect from them. Plants offer rewards or fees in the form of pollen and nectar for pollinators and juicy and nutritious fruits for seed dispersers. But the mutually beneficial system should also be safeguarded against 'cheaters', for example, animals that try to steal nectar without aiding in pollination. Now you can see why plant-animal interactions often involve *co-evolution* of the mutualists, that is, the evolutions of the flower and its pollinator species are tightly linked with one another. In many species of fig trees, there is a tight one-to-one relationship with the pollinator species of wasp (Figure 11.4). It means that a given fig species can be pollinated only by its 'partner' wasp species and no other species. The female wasp uses the fruit not only as an oviposition (egg-laying) site but uses the developing seeds within the fruit for nourishing

its larvae. The wasp pollinates the fig inflorescence while searching for suitable egg-laying sites. In return for the favour of pollination the fig offers the wasp some of its developing seeds, as food for the developing wasp larvae.

Orchids show a bewildering diversity of floral patterns many of which have evolved to attract the right pollinator insect (bees and bumblebees) and ensure guaranteed pollination by it (Figure 11.5). Not all orchids offer rewards. The Mediterranean orchid *Ophrys* employs 'sexual deceit' to get pollination done by a species of bee. One petal of its flower bears an uncanny resemblance to the female of the bee in size, colour and markings. The male bee is attracted to what it perceives as a female, 'pseudocopulates' with the flower, and during that process is dusted with pollen from the flower. When this same bee 'pseudocopulates' with another flower, it transfers pollen to it and thus, pollinates the flower. Here you can see how co-evolution

operates. If the female bee's colour patterns change even slightly for any reason during evolution, pollination success will be reduced unless the orchid flower co-evolves to maintain the resemblance of its petal to the female bee.



**Figure 11.5** Showing bee-a pollinator on orchid flower



## SUMMARY

As a branch of biology, Ecology is the study of the relationships of living organisms with the abiotic (physico-chemical factors) and biotic components (other species) of their environment. It is concerned with four levels of biological organisation-organisms, populations, communities and biomes.

Evolutionary changes through natural selection take place at the population level and hence, population ecology is an important area of ecology. A population is a group of individuals of a given species sharing or competing for similar resources in a defined geographical area. Populations have attributes that individual organisms do not- birth rates and death rates, sex ratio and age distribution. The proportion of different age groups of males and females in a population is often presented graphically as age pyramid; its shape indicates whether a population is stationary, growing or declining.

Ecological effects of any factors on a population are generally reflected in its size (population density), which may be expressed in different ways (numbers, biomass, per cent cover, etc.,) depending on the species.

Populations grow through births and immigration and decline through deaths and emigration. When resources are unlimited, the growth is usually exponential but when resources become progressively limiting, the growth pattern turns logistic. In either case, growth is ultimately limited by the carrying capacity of the environment. The intrinsic rate of natural increase ( $r$ ) is a measure of the inherent potential of a population to grow.

In nature populations of different species in a habitat do not live in isolation but interact in many ways. Depending on the outcome, these interactions between two species are classified as competition (both species suffer), predation and parasitism (one benefits and the other suffers), commensalism (one benefits and the other is unaffected), amensalism (one is harmed, other unaffected) and mutualism (both species benefit). Predation is a very important process through which trophic energy transfer is facilitated and some predators help in controlling their prey populations. Plants have evolved diverse morphological and chemical defenses against herbivory. In competition, it is presumed that the superior competitor eliminates the inferior one (the Competitive Exclusion Principle), but many closely related species have evolved various mechanisms which facilitate their co-existence. Some of the most fascinating cases of mutualism in nature are seen in plant-pollinator interactions.





# EXERCISES

1. List the attributes that populations possess but not individuals.
  2. If a population growing exponentially double in size in 3 years, what is the intrinsic rate of increase ( $r$ ) of the population?
  3. Name important defence mechanisms in plants against herbivory.
  4. An orchid plant is growing on the branch of mango tree. How do you describe this interaction between the orchid and the mango tree?
  5. What is the ecological principle behind the biological control method of managing with pest insects?
  6. Define population and community.
  7. Define the following terms and give one example for each:
    - (a) Commensalism
    - (b) Parasitism
    - (c) Camouflage
    - (d) Mutualism
    - (e) Interspecific competition
  8. With the help of suitable diagram describe the logistic population growth curve.
  9. Select the statement which explains best parasitism.
    - (a) One organism is benefited.
    - (b) Both the organisms are benefited.
    - (c) One organism is benefited, other is not affected.
    - (d) One organism is benefited, other is affected.
  10. List any three important characteristics of a population and explain.
- 
-



# CHAPTER 12

## ECOSYSTEM



### 12.1 Ecosystem–Structure and Function

### 12.2. Productivity

### 12.3 Decomposition

### 12.4 Energy Flow

### 12.5 Ecological Pyramids

An ecosystem can be visualised as a functional unit of nature, where living organisms interact among themselves and also with the surrounding physical environment. Ecosystem varies greatly in size from a small pond to a large forest or a sea. Many ecologists regard the entire biosphere as a global ecosystem, as a composite of all local ecosystems on Earth. Since this system is too much big and complex to be studied at one time, it is convenient to divide it into two basic categories, namely the **terrestrial** and the **aquatic**. Forest, grassland and desert are some examples of terrestrial ecosystems; pond, lake, wetland, river and estuary are some examples of aquatic ecosystems. Crop fields and an aquarium may also be considered as man-made ecosystems.

We will first look at the structure of the ecosystem, in order to appreciate the input (productivity), transfer of energy (food chain/web, nutrient cycling) and the output (degradation and energy loss). We will also look at the relationships – cycles, chains, webs – that are created as a result of these energy flows within the system and their inter- relationship.



## 12.1 ECOSYSTEM – STRUCTURE AND FUNCTION

In earlier classes, you have looked at the various components of the environment- abiotic and biotic. You studied how the individual biotic and abiotic factors affected each other and their surrounding. Let us look at these components in a more integrated manner and see how the flow of energy takes place within these components of the ecosystem.

Interaction of biotic and abiotic components result in a physical structure that is characteristic for each type of ecosystem. Identification and enumeration of plant and animal species of an ecosystem gives its species composition. Vertical distribution of different species occupying different levels is called **stratification**. For example, trees occupy top vertical strata or layer of a forest, shrubs the second and herbs and grasses occupy the bottom layers.

The components of the ecosystem are seen to function as a unit when you consider the following aspects:

- (i) Productivity;
- (ii) Decomposition;
- (iii) Energy flow; and
- (iv) Nutrient cycling.

To understand the ethos of an aquatic ecosystem let us take a small pond as an example. This is fairly a self-sustainable unit and rather simple example that explain even the complex interactions that exist in an aquatic ecosystem. A pond is a shallow water body in which all the above mentioned four basic components of an ecosystem are well exhibited. The abiotic component is the water with all the dissolved inorganic and organic substances and the rich soil deposit at the bottom of the pond. The solar input, the cycle of temperature, day-length and other climatic conditions regulate the rate of function of the entire pond. The autotrophic components include the phytoplankton, some algae and the floating, submerged and marginal plants found at the edges. The consumers are represented by the zooplankton, the free swimming and bottom dwelling forms. The decomposers are the fungi, bacteria and flagellates especially abundant in the bottom of the pond. This system performs all the functions of any ecosystem and of the biosphere as a whole, i.e., conversion of inorganic into organic material with the help of the radiant energy of the sun by the autotrophs; consumption of the autotrophs by heterotrophs; decomposition and mineralisation of the dead matter to release them back for reuse by the autotrophs, these event are repeated over and over again. There is unidirectional movement of energy towards the higher trophic levels and its dissipation and loss as heat to the environment.

## 12.2 PRODUCTIVITY

A constant input of solar energy is the basic requirement for any ecosystem to function and sustain. **Primary production** is defined as the amount of



biomass or organic matter produced per unit area over a time period by plants during photosynthesis. It is expressed in terms of weight ( $\text{g m}^{-2}$ ) or energy ( $\text{kcal m}^{-2}$ ). The rate of biomass production is called **productivity**. It is expressed in terms of  $\text{g m}^{-2} \text{ yr}^{-1}$  or  $(\text{kcal m}^{-2}) \text{ yr}^{-1}$  to compare the productivity of different ecosystems. It can be divided into gross primary productivity (GPP) and net primary productivity (NPP). **Gross primary productivity** of an ecosystem is the rate of production of organic matter during photosynthesis. A considerable amount of GPP is utilised by plants in respiration. Gross primary productivity minus respiration losses (R), is the **net primary productivity** (NPP).

$$\text{GPP} - \text{R} = \text{NPP}$$

Net primary productivity is the available biomass for the consumption to heterotrophs (herbivores and decomposers). **Secondary productivity** is defined as the rate of formation of new organic matter by consumers.

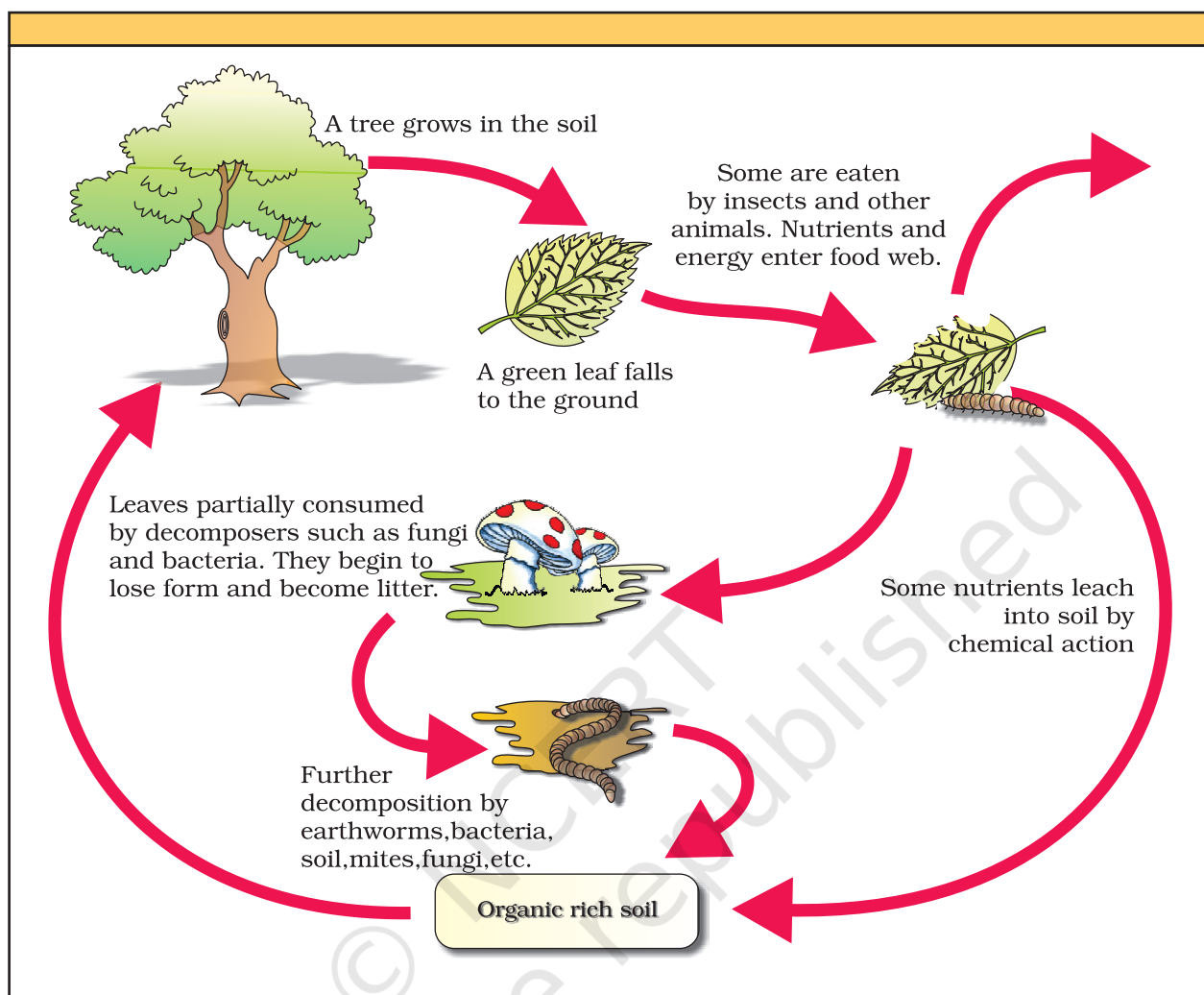
Primary productivity depends on the plant species inhabiting a particular area. It also depends on a variety of environmental factors, availability of nutrients and photosynthetic capacity of plants. Therefore, it varies in different types of ecosystems. The annual net primary productivity of the whole biosphere is approximately 170 billion tons (dry weight) of organic matter. Of this, despite occupying about 70 per cent of the surface, the productivity of the oceans are only 55 billion tons. Rest of course, is on land. *Discuss the main reason for the low productivity of ocean with your teacher.*

### 12.3 DECOMPOSITION

You may have heard of the earthworm being referred to as the farmer's 'friend'. This is so because they help in the breakdown of complex organic matter as well as in loosening of the soil. Similarly, decomposers break down complex organic matter into inorganic substances like carbon dioxide, water and nutrients and the process is called **decomposition**. Dead plant remains such as leaves, bark, flowers and dead remains of animals, including fecal matter, constitute **detritus**, which is the raw material for decomposition. The important steps in the process of decomposition are fragmentation, leaching, catabolism, humification and mineralisation.

**Detritivores** (e.g., earthworm) break down detritus into smaller particles. This process is called **fragmentation**. By the process of **leaching**, water-soluble inorganic nutrients go down into the soil horizon and get precipitated as unavailable salts. Bacterial and fungal enzymes degrade detritus into simpler inorganic substances. This process is called as **catabolism**.

It is important to note that all the above steps in decomposition operate simultaneously on the detritus (Figure 12.1). Humification and mineralisation occur during decomposition in the soil. **Humification** leads



**Figure 12.1** Diagrammatic representation of decomposition cycle in a terrestrial ecosystem

to accumulation of a dark coloured amorphous substance called **humus** that is highly resistant to microbial action and undergoes decomposition at an extremely slow rate. Being colloidal in nature it serves as a reservoir of nutrients. The humus is further degraded by some microbes and release of inorganic nutrients occur by the process known as **mineralisation**.

Decomposition is largely an oxygen-requiring process. The rate of decomposition is controlled by chemical composition of detritus and climatic factors. In a particular climatic condition, decomposition rate is slower if detritus is rich in lignin and chitin, and quicker, if detritus is rich in nitrogen and water-soluble substances like sugars. Temperature and soil moisture are the most important climatic factors that regulate decomposition through their effects on the activities of soil microbes. Warm and moist environment favour decomposition whereas low temperature and anaerobiosis inhibit decomposition resulting in build up of organic materials.



## 12.4 ENERGY FLOW

Except for the deep sea hydro-thermal ecosystem, sun is the only source of energy for all ecosystems on Earth. Of the incident solar radiation less than 50 per cent of it is **photosynthetically active radiation** (PAR). We know that plants and photosynthetic bacteria (autotrophs), fix Sun's radiant energy to make food from simple inorganic materials. Plants capture only 2-10 per cent of the PAR and this small amount of energy sustains the entire living world. So, it is very important to know how the solar energy captured by plants flows through different organisms of an ecosystem. All organisms are dependent for their food on producers, either directly or indirectly. So you find unidirectional flow of energy from the sun to producers and then to consumers. *Is this in keeping with the first law of thermodynamics?*

Further, ecosystems are not exempt from the Second Law of thermodynamics. They need a constant supply of energy to synthesise the molecules they require, to counteract the universal tendency toward increasing disorderliness.

The green plant in the ecosystem are called **producers**. In a terrestrial ecosystem, major producers are herbaceous and woody plants. Likewise, producers in an aquatic ecosystem are various species like phytoplankton, algae and higher plants.

You have read about the food chains and webs that exist in nature. Starting from the plants (or producers) food chains or rather webs are formed such that an animal feeds on a plant or on another animal and in turn is food for another. The chain or web is formed because of this interdependency. No energy that is trapped into an organism remains in it for ever. The energy trapped by the producer, hence, is either passed on to a consumer or the organism dies. Death of organism is the beginning of the detritus food chain/web.

All animals depend on plants (directly or indirectly) for their food needs. They are hence called **consumers** and also heterotrophs. If they feed on the producers, the plants, they are called primary consumers, and if the animals eat other animals which in turn eat the plants (or their produce) they are called secondary consumers. Likewise, you could have tertiary consumers too. Obviously the primary consumers will be **herbivores**. Some common herbivores are insects, birds and mammals in terrestrial ecosystem and molluscs in aquatic ecosystem.

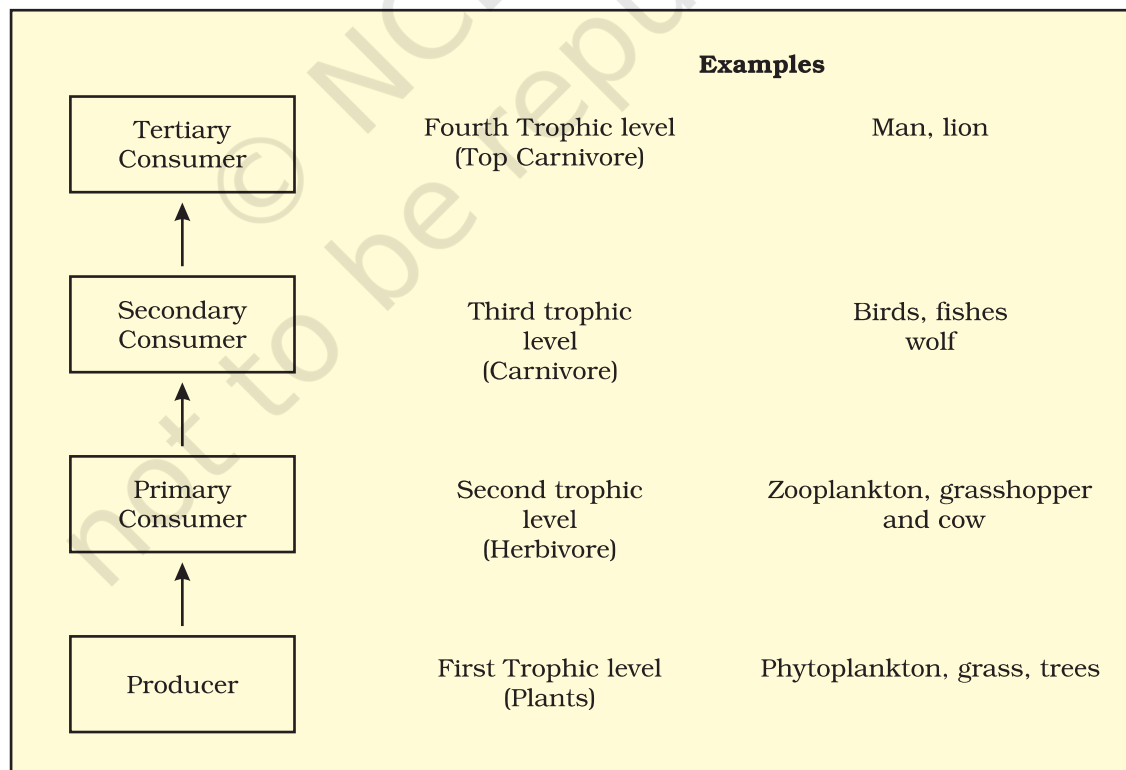
The consumers that feed on these herbivores are carnivores, or more correctly **primary carnivores** (though secondary consumers). Those animals that depend on the primary carnivores for food are labelled **secondary carnivores**. A simple grazing food chain (GFC) is depicted below:



The **detritus food chain** (DFC) begins with dead organic matter. It is made up of **decomposers** which are heterotrophic organisms, mainly fungi and bacteria. They meet their energy and nutrient requirements by degrading dead organic matter or detritus. These are also known as **saprotrophs** (*sapro*: to decompose). Decomposers secrete digestive enzymes that breakdown dead and waste materials into simple, inorganic materials, which are subsequently absorbed by them.

In an aquatic ecosystem, GFC is the major conduit for energy flow. As against this, in a terrestrial ecosystem, a much larger fraction of energy flows through the detritus food chain than through the GFC. Detritus food chain may be connected with the grazing food chain at some levels: some of the organisms of DFC are prey to the GFC animals, and in a natural ecosystem, some animals like cockroaches, crows, etc., are omnivores. These natural interconnection of food chains make it a **food web**. *How would you classify human beings!*

Organisms occupy a place in the natural surroundings or in a community according to their feeding relationship with other organisms. Based on the source of their nutrition or food, organisms occupy a specific place in the food chain that is known as their **trophic level**. Producers belong to the first trophic level, herbivores (primary consumer) to the second and carnivores (secondary consumer) to the third (Figure 12.2).



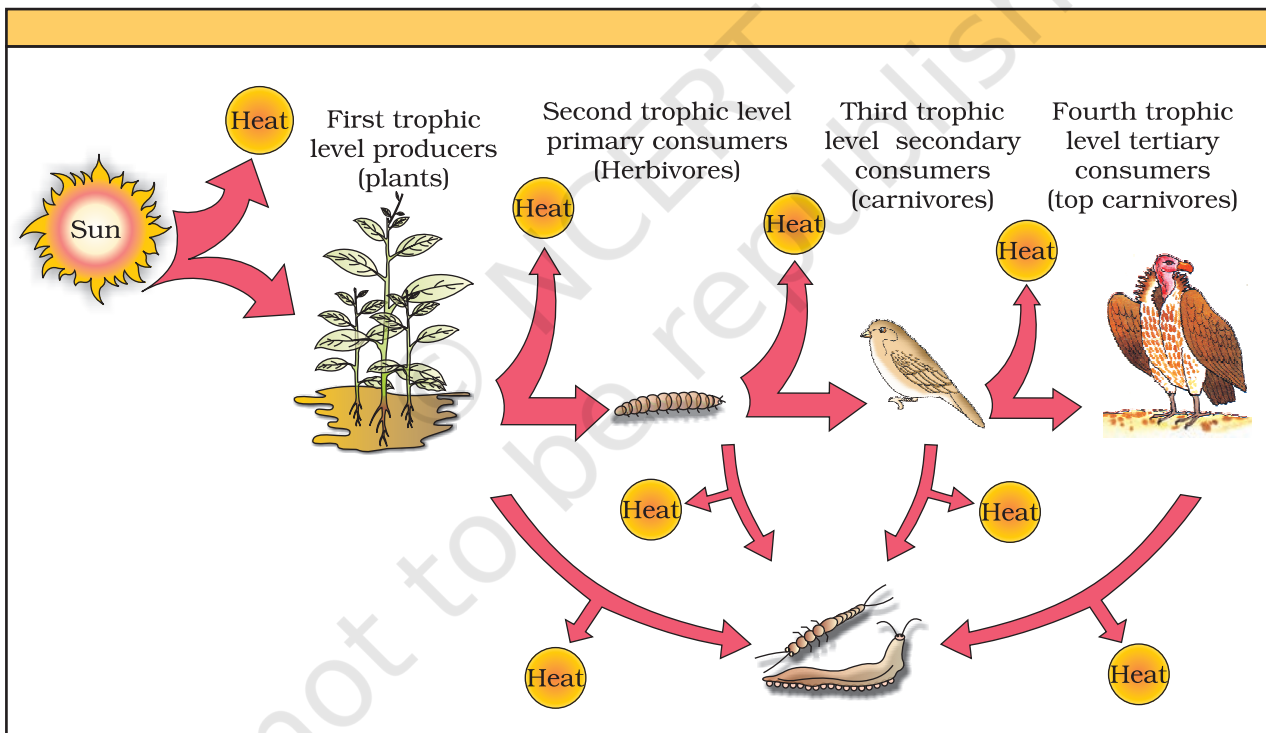
**Figure 12.2** Diagrammatic representation of trophic levels in an ecosystem



The important point to note is that the amount of energy decreases at successive trophic levels. When any organism dies it is converted to detritus or dead biomass that serves as an energy source for decomposers. Organisms at each trophic level depend on those at the lower trophic level for their energy demands.

Each trophic level has a certain mass of living material at a particular time called as the **standing crop**. The standing crop is measured as the mass of living organisms (**biomass**) or the number in a unit area. The biomass of a species is expressed in terms of fresh or dry weight. Measurement of biomass in terms of dry weight is more accurate. *Why?*

The number of trophic levels in the grazing food chain is restricted as the transfer of energy follows 10 per cent law – only 10 per cent of the energy is transferred to each trophic level from the lower trophic level. In nature, it is possible to have so many levels – producer, herbivore, primary carnivore, secondary carnivore in the grazing food chain (Figure 12.3) . *Do you think there is any such limitation in a detritus food chain?*



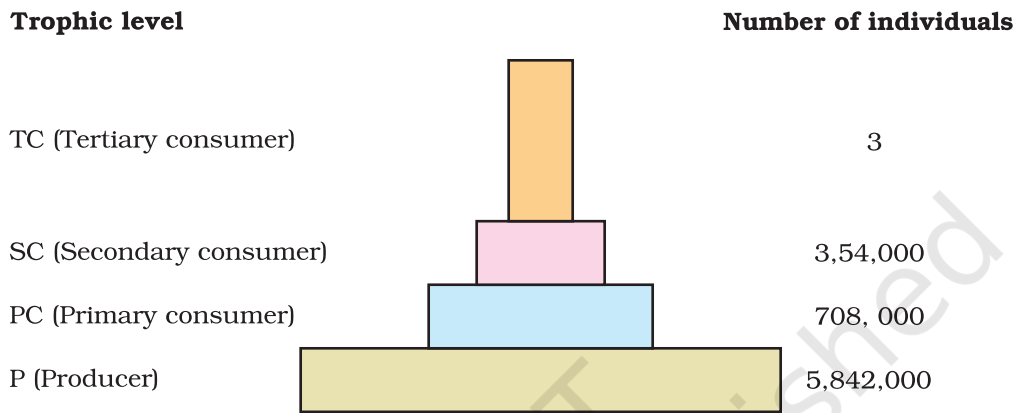
**Figure 12.3** Energy flow through different trophic levels

### 12.5 ECOLOGICAL PYRAMIDS

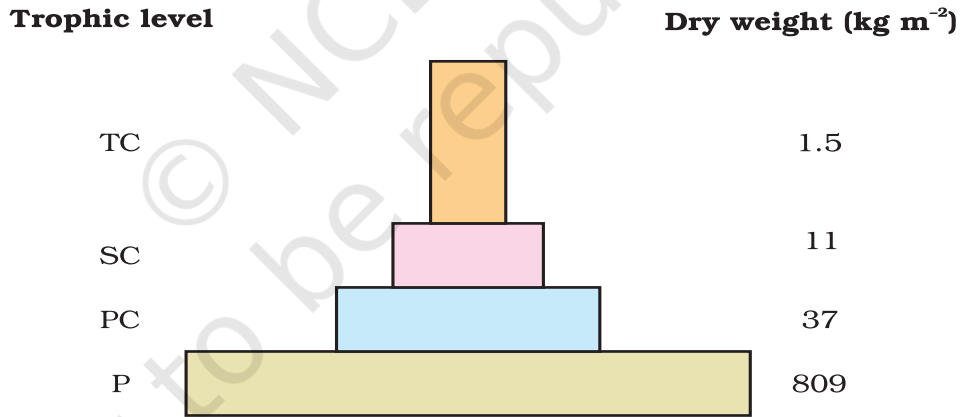
You must be familiar with the shape of a pyramid. The base of a pyramid is broad and it narrows towards the apex. One gets a similar shape, whether you express the food or energy relationship between organisms



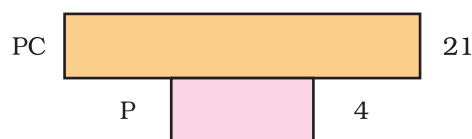
at different trophic levels. This, relationship is expressed in terms of number, biomass or energy. The base of each pyramid represents the producers or the first trophic level while the apex represents tertiary or top level consumer. The three types of ecological pyramids that are usually studied are (a) pyramid of number; (b) pyramid of biomass and (c) pyramid of energy. For detail (see Figure 12.4 a, b, c and d).



**Figure 12.4 (a)** Pyramid of numbers in a grassland ecosystem. Only three top-carnivores are supported in an ecosystem based on production of nearly 6 millions plants

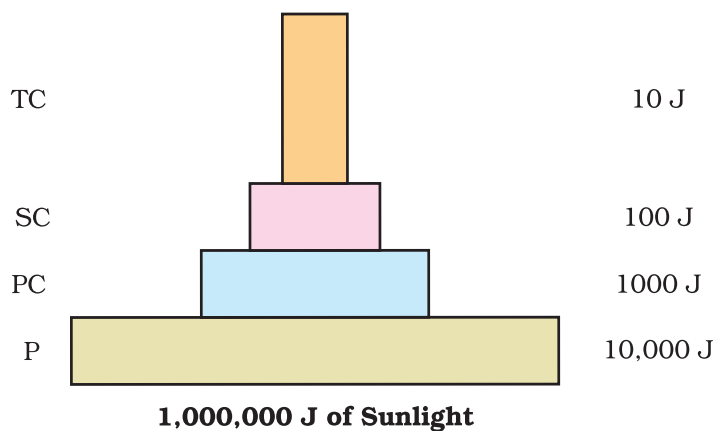


**Figure 12.4 (b)** Pyramid of biomass shows a sharp decrease in biomass at higher trophic levels



**Figure 12.4 (c)** Inverted pyramid of biomass-small standing crop of phytoplankton supports large standing crop of zooplankton





**Figure 12.4 (d)** An ideal pyramid of energy. Observe that primary producers convert only 1% of the energy in the sunlight available to them into NPP

Any calculations of energy content, biomass or numbers, has to include all organisms at that trophic level. No generalisations we make will be true if we take only a few individuals at any trophic level into account. Also a given organism may occupy more than one trophic level simultaneously. One must remember that the trophic level represents a functional level, not a species as such. A given species may occupy more than one trophic level in the same ecosystem at the same time; for example, a sparrow is a primary consumer when it eats seeds, fruits, peas, and a secondary consumer when it eats insects and worms. *Can you work out how many trophic levels human beings function at in a food chain?*

In most ecosystems, all the pyramids, of number, of energy and biomass are upright, i.e., producers are more in number and biomass than the herbivores, and herbivores are more in number and biomass than the carnivores. Also energy at a lower trophic level is always more than at a higher level.

There are exceptions to this generalisation: If you were to count the number of insects feeding on a big tree what kind of pyramid would you get? Now add an estimate of the number of small birds depending on the insects, as also the number of larger birds eating the smaller. Draw the shape you would get.

The pyramid of biomass in sea is generally inverted because the biomass of fishes far exceeds that of phytoplankton. *Isn't that a paradox? How would you explain this?*

Pyramid of energy is always upright, can never be inverted, because when energy flows from a particular trophic level to the next trophic level, some energy is always lost as heat at each step. Each bar in the energy pyramid indicates the amount of energy present at each trophic level in a given time or annually per unit area.



However, there are certain limitations of ecological pyramids such as it does not take into account the same species belonging to two or more trophic levels. It assumes a simple food chain, something that almost never exists in nature; it does not accommodate a food web. Moreover, saprophytes are not given any place in ecological pyramids even though they play a vital role in the ecosystem.

### SUMMARY

An ecosystem is a structural and functional unit of nature and it comprises abiotic and biotic components. Abiotic components are inorganic materials- air, water and soil, whereas biotic components are producers, consumers and decomposers. Each ecosystem has characteristic physical structure resulting from interaction amongst abiotic and biotic components. Species composition and stratification are the two main structural features of an ecosystem. Based on source of nutrition every organism occupies a place in an ecosystem.

Productivity, decomposition, energy flow, and nutrient cycling are the four important components of an ecosystem. Primary productivity is the rate of capture of solar energy or biomass production of the producers. It is divided into two types: gross primary productivity (GPP) and net primary productivity (NPP). Rate of capture of solar energy or total production of organic matter is called as GPP. NPP is the remaining biomass or the energy left after utilisation of producers. Secondary productivity is the rate of assimilation of food energy by the consumers. In decomposition, complex organic compounds of detritus are converted to carbon dioxide, water and inorganic nutrients by the decomposers. Decomposition involves three processes, namely fragmentation of detritus, leaching and catabolism.

Energy flow is unidirectional. First, plants capture solar energy and then, food is transferred from the producers to decomposers. Organisms of different trophic levels in nature are connected to each other for food or energy relationship forming a food chain. The storage and movement of nutrient elements through the various components of the ecosystem is called nutrient cycling; nutrients are repeatedly used through this process. Nutrient cycling is of two types—gaseous and sedimentary. Atmosphere or hydrosphere is the reservoir for the gaseous type of cycle (carbon), whereas Earth's crust is the reservoir for sedimentary type (phosphorus). Products of ecosystem processes are named as ecosystem services, e.g., purification of air and water by forests.

## EXERCISES

1. Fill in the blanks.
  - (a) Plants are called as \_\_\_\_\_ because they fix carbon dioxide.
  - (b) In an ecosystem dominated by trees, the pyramid (of numbers) is \_\_\_\_\_ type.

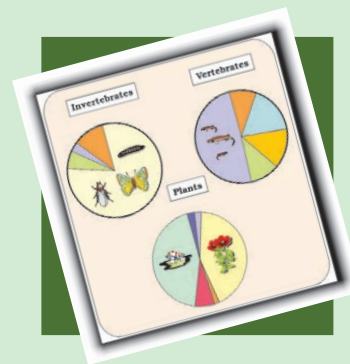
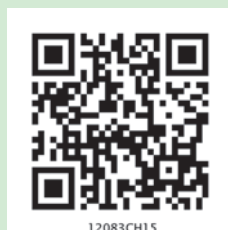
## ECOSYSTEM



- (c) In aquatic ecosystems, the limiting factor for the productivity is\_\_\_\_\_.
- (d) Common detritivores in our ecosystem are\_\_\_\_\_.
- (e) The major reservoir of carbon on earth is\_\_\_\_\_.
2. Which one of the following has the largest population in a food chain?
- (a) Producers
- (b) Primary consumers
- (c) Secondary consumers
- (d) Decomposers
3. The second trophic level in a lake is
- (a) Phytoplankton
- (b) Zooplankton
- (c) Benthos
- (d) Fishes
4. Secondary producers are
- (a) Herbivores
- (b) Producers
- (c) Carnivores
- (d) None of the above
5. What is the percentage of photosynthetically active radiation (PAR) in the incident solar radiation?
- (a) 100%
- (b) 50 %
- (c) 1-5%
- (d) 2-10%
6. Distinguish between
- (a) Grazing food chain and detritus food chain
- (b) Production and decomposition
- (c) Upright and inverted pyramid
- (d) Food chain and Food web
- (e) Litter and detritus
- (f) Primary and secondary productivity
7. Describe the components of an ecosystem.
8. Define ecological pyramids and describe with examples, pyramids of number and biomass.
9. What is primary productivity? Give brief description of factors that affect primary productivity.
10. Define decomposition and describe the processes and products of decomposition.
11. Give an account of energy flow in an ecosystem.
- 
-

# CHAPTER 13

# BIODIVERSITY AND CONSERVATION



## 13.1 Biodiversity

## 13.2 Biodiversity Conservation

If an alien from a distant galaxy were to visit our planet Earth, the first thing that would amaze and baffle him would most probably be the enormous diversity of life that he would encounter. Even for humans, the rich variety of living organisms with which they share this planet never ceases to astonish and fascinate us. The common man would find it hard to believe that there are more than 20,000 species of ants, 3,00,000 species of beetles, 28,000 species of fishes and nearly 20,000 species of orchids. Ecologists and evolutionary biologists have been trying to understand the significance of such diversity by asking important questions— *Why are there so many species? Did such great diversity exist throughout earth's history? How did this diversification come about? How and why is this diversity important to the biosphere? Would it function any differently if the diversity was much less? How do humans benefit from the diversity of life?*

### 13.1 BIODIVERSITY

In our biosphere immense diversity (or heterogeneity) exists not only at the species level but at all levels of biological organisation ranging from macromolecules within cells to biomes. Biodiversity is the term popularised by the sociobiologist Edward Wilson to describe the



combined diversity at all the levels of biological organisation.

The most important of them are–

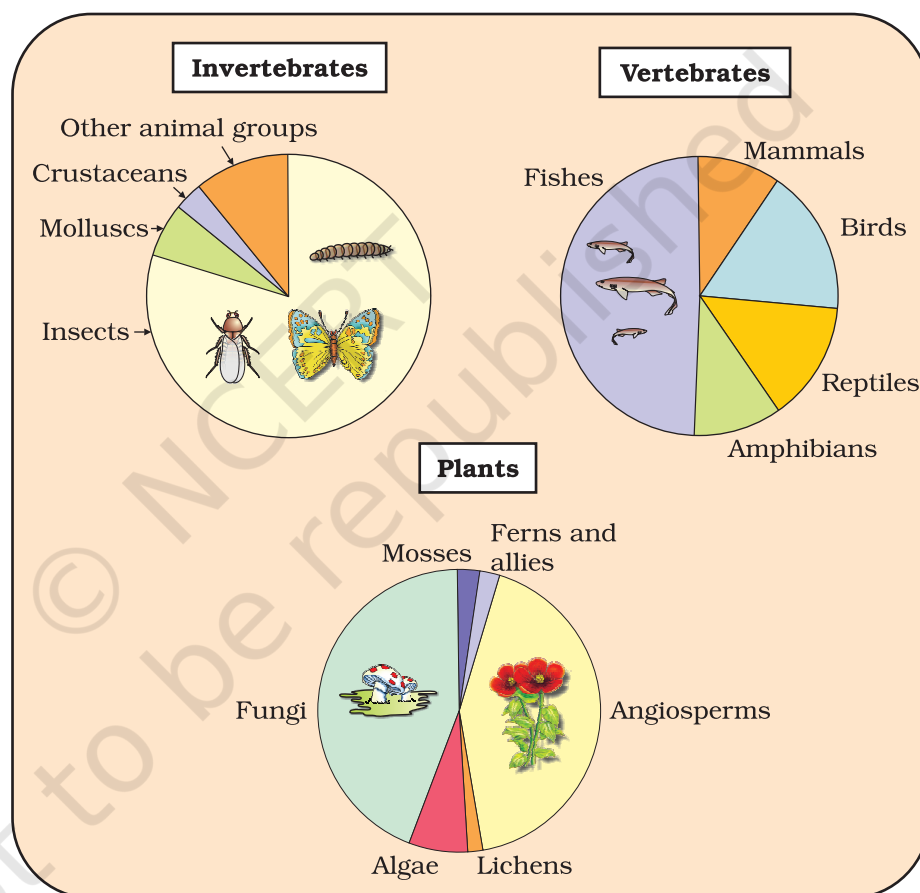
- (i) **Genetic diversity:** A single species might show high diversity at the genetic level over its distributional range. The genetic variation shown by the medicinal plant *Rauwolfia vomitoria* growing in different Himalayan ranges might be in terms of the potency and concentration of the active chemical (reserpine) that the plant produces. India has more than 50,000 genetically different strains of rice, and 1,000 varieties of mango.
- (ii) **Species diversity:** The diversity at the species level, for example, the Western Ghats have a greater amphibian species diversity than the Eastern Ghats.
- (iii) **Ecological diversity:** At the ecosystem level, India, for instance, with its deserts, rain forests, mangroves, coral reefs, wetlands, estuaries, and alpine meadows has a greater ecosystem diversity than a Scandinavian country like Norway.

It has taken millions of years of evolution, to accumulate this rich diversity in nature, but we could lose all that wealth in less than two centuries if the present rates of species losses continue. Biodiversity and its conservation are now vital environmental issues of international concern as more and more people around the world begin to realise the critical importance of biodiversity for our survival and well-being on this planet.

### 13.1.1 How Many Species are there on Earth and How Many in India?

Since there are published records of all the species discovered and named, we know how many species in all have been recorded so far, but it is not easy to answer the question of how many species there are on earth. According to the International Union for Conservation of Nature and Natural Resources (IUCN) (2004), the total number of plant and animal species described so far is slightly more than 1.5 million, but we have no clear idea of how many species are yet to be discovered and described. Estimates vary widely and many of them are only educated guesses. For many taxonomic groups, species inventories are more complete in temperate than in tropical countries. Considering that an overwhelmingly large proportion of the species waiting to be discovered are in the tropics, biologists make a statistical comparison of the temperate-tropical species richness of an exhaustively studied group of insects and extrapolate this ratio to other groups of animals and plants to come up with a gross estimate of the total number of species on earth. Some extreme estimates range from 20 to 50 million, but a more conservative and scientifically sound estimate made by Robert May places the global species diversity at about 7 million.

Let us look at some interesting aspects about earth's biodiversity based on the currently available species inventories. More than 70 per cent of all the species recorded are animals, while plants (including algae, fungi, bryophytes, gymnosperms and angiosperms) comprise no more than 22 per cent of the total. Among animals, insects are the most species-rich taxonomic group, making up more than 70 per cent of the total. That means, out of every 10 animals on this planet, 7 are insects. Again, how do we explain this enormous diversification of insects? The number of fungi species in the world is more than the combined total of the species of fishes, amphibians, reptiles and mammals. In Figure 13.1, biodiversity is depicted showing species number of major taxa.



**Figure 13.1** Representing global biodiversity: proportionate number of species of major taxa of plants, invertebrates and vertebrates

It should be noted that these estimates do not give any figures for prokaryotes. Biologists are not sure about how many prokaryotic species there might be. The problem is that conventional taxonomic methods are not suitable for identifying microbial species and many species are simply not culturable under laboratory conditions. If we accept biochemical or molecular criteria for delineating species for this group, then their diversity alone might run into millions.



Although India has only 2.4 per cent of the world's land area, its share of the global species diversity is an impressive 8.1 per cent. That is what makes our country one of the 12 mega diversity countries of the world. Nearly 45,000 species of plants and twice as many of animals have been recorded from India. How many living species are actually there waiting to be discovered and named? If we accept May's global estimates, only 22 per cent of the total species have been recorded so far. Applying this proportion to India's diversity figures, we estimate that there are probably more than 1,00,000 plant species and more than 3,00,000 animal species yet to be discovered and described. Would we ever be able to complete the inventory of the biological wealth of our country? Consider the immense trained manpower (taxonomists) and the time required to complete the job. The situation appears more hopeless when we realise that a large fraction of these species faces the threat of becoming extinct even before we discover them. Nature's biological library is burning even before we catalogued the titles of all the books stocked there.

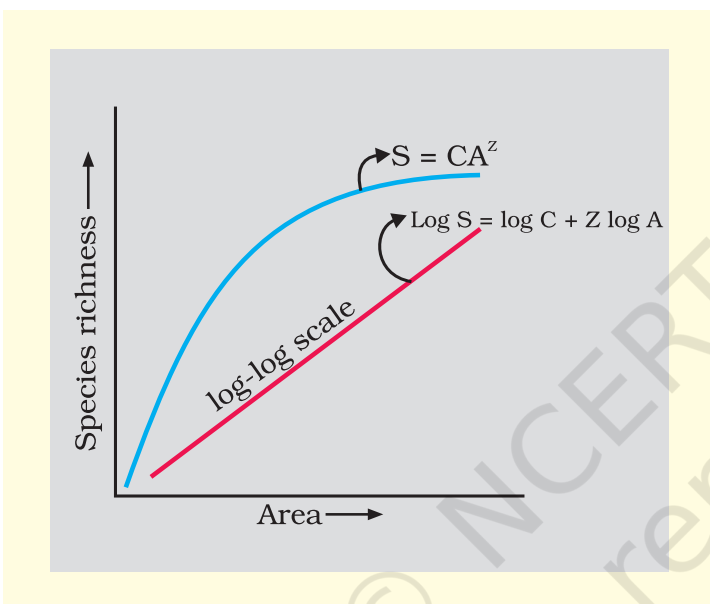
### 13.1.2 Patterns of Biodiversity

- (i) **Latitudinal gradients:** The diversity of plants and animals is not uniform throughout the world but shows a rather uneven distribution. For many group of animals or plants, there are interesting patterns in diversity, the most well-known being the latitudinal gradient in diversity. In general, species diversity decreases as we move away from the equator towards the poles. With very few exceptions, tropics (latitudinal range of 23.5° N to 23.5° S) harbour more species than temperate or polar areas. Colombia located near the equator has nearly 1,400 species of birds while New York at 41° N has 105 species and Greenland at 71° N only 56 species. India, with much of its land area in the tropical latitudes, has more than 1,200 species of birds. A forest in a tropical region like Equador has up to 10 times as many species of vascular plants as a forest of equal area in a temperate region like the Midwest of the USA. The largely tropical Amazonian rain forest in South America has the greatest biodiversity on earth- it is home to more than 40,000 species of plants, 3,000 of fishes, 1,300 of birds, 427 of mammals, 427 of amphibians, 378 of reptiles and of more than 1,25,000 invertebrates. Scientists estimate that in these rain forests there might be at least two million insect species waiting to be discovered and named.

*What is so special about tropics that might account for their greater biological diversity?* Ecologists and evolutionary biologists have proposed various hypotheses; some important ones are (a) Speciation is generally a function of time, unlike temperate regions subjected to frequent glaciations in the past, tropical latitudes have remained relatively undisturbed for millions of years and thus, had a long

evolutionary time for species diversification, (b) Tropical environments, unlike temperate ones, are less seasonal, relatively more constant and predictable. Such constant environments promote niche specialisation and lead to a greater species diversity and (c) There is more solar energy available in the tropics, which contributes to higher productivity; this in turn might contribute indirectly to greater diversity.

- (ii) **Species-Area relationships**: During his pioneering and extensive explorations in the wilderness of South American jungles, the great German naturalist and geographer Alexander von Humboldt



**Figure 13.2** Showing species area relationship. Note that on log scale the relationship becomes linear

observed that within a region species richness increased with increasing explored area, but only up to a limit. In fact, the relation between species richness and area for a wide variety of taxa (angiosperm plants, birds, bats, freshwater fishes) turns out to be a rectangular hyperbola (Figure 13.2). On a logarithmic scale, the relationship is a straight line described by the equation

$$\log S = \log C + Z \log A$$

where

S = Species richness    A = Area

Z = slope of the line (regression coefficient)

C = Y-intercept

Ecologists have discovered that the value of Z lies in the range of 0.1 to 0.2, regardless of the taxonomic group or the region (whether it is the plants in Britain,

birds in California or molluscs in New York state, the slopes of the regression line are amazingly similar). But, if you analyse the species-area relationships among very large areas like the entire continents, you will find that the slope of the line to be much steeper (Z values in the range of 0.6 to 1.2). For example, for frugivorous (fruit-eating) birds and mammals in the tropical forests of different continents, the slope is found to be 1.15. *What do steeper slopes mean in this context?*

### 13.1.3 The importance of Species Diversity to the Ecosystem

Does the number of species in a community really matter to the functioning of the ecosystem? This is a question for which ecologists have not been able to give a definitive answer. For many decades, ecologists believed that communities with more species, generally, tend to be more stable than those with less species. What exactly is stability for a biological





community? A stable community should not show too much variation in productivity from year to year; it must be either resistant or resilient to occasional disturbances (natural or man-made), and it must also be resistant to invasions by alien species. We don't know how these attributes are linked to species richness in a community, but David Tilman's long-term ecosystem experiments using outdoor plots provide some tentative answers. Tilman found that plots with more species showed less year-to-year variation in total biomass. He also showed that in his experiments, increased diversity contributed to higher productivity.

Although, we may not understand completely how species richness contributes to the well-being of an ecosystem, we know enough to realise that rich biodiversity is not only essential for ecosystem health but imperative for the very survival of the human race on this planet. At a time when we are losing species at an alarming pace, one might ask—Does it really matter to us if a few species become extinct? Would Western Ghats ecosystems be less functional if one of its tree frog species is lost forever? How is our quality of life affected if, say, instead of 20,000 we have only 15,000 species of ants on earth?

There are no direct answers to such naïve questions but we can develop a proper perspective through an analogy (the 'rivet popper hypothesis') used by Stanford ecologist Paul Ehrlich. In an airplane (ecosystem) all parts are joined together using thousands of rivets (species). If every passenger travelling in it starts popping a rivet to take home (causing a species to become extinct), it may not affect flight safety (proper functioning of the ecosystem) initially, but as more and more rivets are removed, the plane becomes dangerously weak over a period of time. Furthermore, which rivet is removed may also be critical. Loss of rivets on the wings (key species that drive major ecosystem functions) is obviously a more serious threat to flight safety than loss of a few rivets on the seats or windows inside the plane.

#### **13.1.4 Loss of Biodiversity**

While it is doubtful if any new species are being added (through speciation) into the earth's treasury of species, there is no doubt about their continuing losses. The biological wealth of our planet has been declining rapidly and the accusing finger is clearly pointing to human activities. The colonisation of tropical Pacific Islands by humans is said to have led to the extinction of more than 2,000 species of native birds. The IUCN Red List (2004) documents the extinction of 784 species (including 338 vertebrates, 359 invertebrates and 87 plants) in the last 500 years. Some examples of recent extinctions include the dodo (Mauritius), quagga (Africa), thylacine (Australia), Steller's Sea Cow (Russia) and three subspecies (Bali, Javan, Caspian) of tiger. The last twenty years alone have witnessed the disappearance of 27 species. Careful analysis of records



shows that extinctions across taxa are not random; some groups like amphibians appear to be more vulnerable to extinction. Adding to the grim scenario of extinctions is the fact that more than 15,500 species world-wide are facing the threat of extinction. Presently, 12 per cent of all bird species, 23 per cent of all mammal species, 32 per cent of all amphibian species and 31 per cent of all gymnosperm species in the world face the threat of extinction.

From a study of the history of life on earth through fossil records, we learn that large-scale loss of species like the one we are currently witnessing have also happened earlier, even before humans appeared on the scene. During the long period (> 3 billion years) since the origin and diversification of life on earth there were five episodes of mass extinction of species. How is the 'Sixth Extinction' presently in progress different from the previous episodes? The difference is in the rates; the current species extinction rates are estimated to be 100 to 1,000 times faster than in the pre-human times and our activities are responsible for the faster rates. Ecologists warn that if the present trends continue, nearly half of all the species on earth might be wiped out within the next 100 years.

In general, loss of biodiversity in a region may lead to (a) decline in plant production, (b) lowered resistance to environmental perturbations such as drought and (c) increased variability in certain ecosystem processes such as plant productivity, water use, and pest and disease cycles.

**Causes of biodiversity losses:** The accelerated rates of species extinctions that the world is facing now are largely due to human activities. There are four major causes ('The Evil Quartet' is the sobriquet used to describe them).

- (i) **Habitat loss and fragmentation:** This is the most important cause driving animals and plants to extinction. The most dramatic examples of habitat loss come from tropical rain forests. Once covering more than 14 per cent of the earth's land surface, these rain forests now cover no more than 6 per cent. They are being destroyed fast. By the time you finish reading this chapter, 1000 more hectares of rain forest would have been lost. The Amazon rain forest (it is so huge that it is called the 'lungs of the planet') harbouring probably millions of species is being cut and cleared for cultivating *soya beans* or for conversion to grasslands for raising beef cattle. Besides total loss, the degradation of many habitats by pollution also threatens the survival of many species. When large habitats are broken up into small fragments due to various human activities, mammals and birds requiring large territories and certain animals with migratory habits are badly affected, leading to population declines.
- (ii) **Over-exploitation:** Humans have always depended on nature for food and shelter, but when 'need' turns to 'greed', it leads to



over-exploitation of natural resources. Many species extinctions in the last 500 years (Steller's sea cow, passenger pigeon) were due to overexploitation by humans. Presently many marine fish populations around the world are over harvested, endangering the continued existence of some commercially important species.

- (iii) **Alien species invasions:** When alien species are introduced unintentionally or deliberately for whatever purpose, some of them turn invasive, and cause decline or extinction of indigenous species. The Nile perch introduced into Lake Victoria in east Africa led eventually to the extinction of an ecologically unique assemblage of more than 200 species of cichlid fish in the lake. You must be familiar with the environmental damage caused and threat posed to our native species by invasive weed species like carrot grass (*Parthenium*), *Lantana* and water hyacinth (*Eichornia*). The recent illegal introduction of the African catfish *Clarias gariepinus* for aquaculture purposes is posing a threat to the indigenous catfishes in our rivers.
- (iv) **Co-extinctions:** When a species becomes extinct, the plant and animal species associated with it in an obligatory way also become extinct. When a host fish species becomes extinct, its unique assemblage of parasites also meets the same fate. Another example is the case of a coevolved plant-pollinator mutualism where extinction of one invariably leads to the extinction of the other.

## 13.2 BIODIVERSITY CONSERVATION

### 13.2.1 Why Should We Conserve Biodiversity?

There are many reasons, some obvious and others not so obvious, but all equally important. They can be grouped into three categories: narrowly utilitarian, broadly utilitarian, and ethical.

The **narrowly utilitarian** arguments for conserving biodiversity are obvious; humans derive countless direct economic benefits from nature-food (cereals, pulses, fruits), firewood, fibre, construction material, industrial products (tannins, lubricants, dyes, resins, perfumes ) and products of medicinal importance. More than 25 per cent of the drugs currently sold in the market worldwide are derived from plants and 25,000 species of plants contribute to the traditional medicines used by native peoples around the world. Nobody knows how many more medicinally useful plants there are in tropical rain forests waiting to be explored. With increasing resources put into 'bioprospecting' (exploring molecular, genetic and species-level diversity for products of economic importance), nations endowed with rich biodiversity can expect to reap enormous benefits.

The **broadly utilitarian** argument says that biodiversity plays a major role in many ecosystem services that nature provides. The fast-



dwindling Amazon forest is estimated to produce, through photosynthesis, 20 per cent of the total oxygen in the earth's atmosphere. Can we put an economic value on this service by nature? You can get some idea by finding out how much your neighborhood hospital spends on a cylinder of oxygen. Pollination (without which plants cannot give us fruits or seeds) is another service, ecosystems provide through pollinators layer – bees, bumblebees, birds and bats. *What will be the costs of accomplishing pollination without help from natural pollinators?* There are other intangible benefits – that we derive from nature—the aesthetic pleasures of walking through thick woods, watching spring flowers in full bloom or waking up to a bulbul's song in the morning. Can we put a price tag on such things?

The **ethical** argument for conserving biodiversity relates to what we owe to millions of plant, animal and microbe species with whom we share this planet. Philosophically or spiritually, we need to realise that every species has an intrinsic value, even if it may not be of current or any economic value to us. We have a moral duty to care for their well-being and pass on our biological legacy in good order to future generations.

### 13.2.2 How do we conserve Biodiversity?

When we conserve and protect the whole ecosystem, its biodiversity at all levels is protected - we save the entire forest to save the tiger. This approach is called *in situ* (on site) conservation. However, when there are situations where an animal or plant is endangered or threatened (organisms facing a very high risk of extinction in the wild in the near future) and needs urgent measures to save it from extinction, *ex situ* (off site) conservation is the desirable approach.

**In situ conservation**– Faced with the conflict between development and conservation, many nations find it unrealistic and economically not feasible to conserve all their biological wealth. Invariably, the number of species waiting to be saved from extinction far exceeds the conservation resources available. On a global basis, this problem has been addressed by eminent conservationists. They identified for maximum protection certain 'biodiversity hotspots' regions with very high levels of species richness and high degree of **endemism** (that is, species confined to that region and not found anywhere else). Initially 25 biodiversity hotspots were identified but subsequently nine more have been added to the list, bringing the total number of biodiversity hotspots in the world to 34. These hotspots are also regions of accelerated habitat loss. Three of these hotspots – Western Ghats and Sri Lanka, Indo-Burma and Himalaya – cover our country's exceptionally high biodiversity regions. Although all the biodiversity hotspots put together cover less than 2 per cent of the earth's land area, the number of species they collectively



harbour is extremely high and strict protection of these hotspots could reduce the ongoing mass extinctions by almost 30 per cent.

In India, ecologically unique and biodiversity-rich regions are legally protected as biosphere reserves, national parks and sanctuaries. India now has 14 biosphere reserves, 90 national parks and 448 wildlife sanctuaries. India has also a history of religious and cultural traditions that emphasised protection of nature. In many cultures, tracts of forest were set aside, and all the trees and wildlife within were venerated and given total protection. Such **sacred groves** are found in Khasi and Jaintia Hills in Meghalaya, Aravalli Hills of Rajasthan, Western Ghat regions of Karnataka and Maharashtra and the Sarguja, Chanda and Bastar areas of Madhya Pradesh. In Meghalaya, the sacred groves are the last refuges for a large number of rare and threatened plants.

**Ex situ Conservation**– In this approach, threatened animals and plants are taken out from their natural habitat and placed in special setting where they can be protected and given special care. Zoological parks, botanical gardens and wildlife safari parks serve this purpose. There are many animals that have become extinct in the wild but continue to be maintained in zoological parks. In recent years *ex situ* conservation has advanced beyond keeping threatened species in enclosures. Now gametes of threatened species can be preserved in viable and fertile condition for long periods using cryopreservation techniques, eggs can be fertilised *in vitro*, and plants can be propagated using tissue culture methods. Seeds of different genetic strains of commercially important plants can be kept for long periods in seed banks.

Biodiversity knows no political boundaries and its conservation is therefore a collective responsibility of all nations. The historic Convention on Biological Diversity ('The Earth Summit') held in Rio de Janeiro in 1992, called upon all nations to take appropriate measures for conservation of biodiversity and sustainable utilisation of its benefits. In a follow-up, the World Summit on Sustainable Development held in 2002 in Johannesburg, South Africa, 190 countries pledged their commitment to achieve by 2010, a significant reduction in the current rate of biodiversity loss at global, regional and local levels.

### SUMMARY

Since life originated on earth nearly 3.8 billion years ago, there had been enormous diversification of life forms on earth. Biodiversity refers to the sum total of diversity that exists at all levels of biological organisation. Of particular importance is the diversity at genetic, species and ecosystem levels and conservation efforts are aimed at protecting diversity at all these levels.

More than 1.5 million species have been recorded in the world, but there might still be nearly 6 million species on earth waiting to be





discovered and named. Of the named species, > 70 per cent are animals, of which 70 per cent are insects. The group Fungi has more species than all the vertebrate species combined. India, with about 45,000 species of plants and twice as many species of animals, is one of the 12 mega diversity countries of the world.

Species diversity on earth is not uniformly distributed but shows interesting patterns. It is generally highest in the tropics and decreases towards the poles. Important explanations for the species richness of the tropics are: Tropics had more evolutionary time; they provide a relatively constant environment and, they receive more solar energy which contributes to greater productivity. Species richness is also function of the area of a region; the species-area relationship is generally a rectangular hyperbolic function.

It is believed that communities with high diversity tend to be less variable, more productive and more resistant to biological invasions. Earth's fossil history reveals incidence of mass extinctions in the past, but the present rates of extinction, largely attributed to human activities, are 100 to 1000 times higher. Nearly 700 species have become extinct in recent times and more than 15,500 species (of which > 650 are from India) currently face the threat of extinction. The causes of high extinction rates at present include habitat (particularly forests) loss and fragmentation, over-exploitation, biological invasions and co-extinctions.

Earth's rich biodiversity is vital for the very survival of mankind. The reasons for conserving biodiversity are narrowly utilitarian, broadly utilitarian and ethical. Besides the direct benefits (food, fibre, firewood, pharmaceuticals, etc.), there are many indirect benefits we receive through ecosystem services such as pollination, pest control, climate moderation and flood control. We also have a moral responsibility to take good care of earth's biodiversity and pass it on in good order to our next generation.

Biodiversity conservation may be *in situ* as well as *ex situ*. In *in situ* conservation, the endangered species are protected in their natural habitat so that the entire ecosystem is protected. Recently, 34 'biodiversity hotspots' in the world have been proposed for intensive conservation efforts. Of these, three (Western Ghats-Sri Lanka, Himalaya and Indo-Burma) cover India's rich biodiversity regions. Our country's *in situ* conservation efforts are reflected in its 14 biosphere reserves, 90 national parks, > 450 wildlife sanctuaries and many sacred groves. *Ex situ* conservation methods include protective maintenance of threatened species in zoological parks and botanical gardens, *in vitro* fertilisation, tissue culture propagation and cryopreservation of gametes.

## EXERCISES

1. Name the three important components of biodiversity.
2. How do ecologists estimate the total number of species present in the world?



3. Give three hypotheses for explaining why tropics show greatest levels of species richness.
4. What is the significance of the slope of regression in a species – area relationship?
5. What are the major causes of species losses in a geographical region?
6. How is biodiversity important for ecosystem functioning?
7. What are sacred groves? What is their role in conservation?
8. Among the ecosystem services are control of floods and soil erosion. How is this achieved by the biotic components of the ecosystem?
9. The species diversity of plants (22 per cent) is much less than that of animals (72 per cent). What could be the explanations to how animals achieved greater diversification?
10. Can you think of a situation where we deliberately want to make a species extinct? How would you justify it?

© NCERT  
not to be republished

# NOTES

---

© NCERT  
not to be republished